

PRODUCT LINE 2017 - 2018

LAMINA TECHNOLOGIES

PRODUCT CATALOG 2017 - 2018

TABLE OF CONTENTS

INTRODUCTION	2
TURNING	7
ALU TURNING	41
PARTING AND GROOVING	47
THREAD TURNING	53
MILLING	63
FACE MILLING	69
SHOULDER MILLING	91
HIGH FEED MILLING	111
COPY MILLING	121
SLOT MILLING	133
ALU MILLING	139
SOLID END MILLS	147
THREAD MILLING	165
DRILLING	171
TECHNICAL INFORMATION	183
MACHINING CONDITIONS	185
TECHNICAL GUIDE	313
LAMINA MATERIAL GUIDE	327
INDEX OF INSERTS	335





LAMINA TECHNOLOGIES

Lamina Technologies is a manufacturer of carbide cutting tools established in Switzerland in 2002.

From its inception, Lamina has been focused on understanding customers' needs and striving to exceed their expectations.

Since as early as 2003, we have been the global pioneers of the ground-breaking Multi-Mat™ concept that, through innovative technologies, allows cutting tools to work on a multitude of materials. This reduces our customers' stock of unused and obsolete cutting tools, increases production flexibility and improves efficiency.

SWISS MANUFACTURER OF CARBIDE CUTTING TOOLS

Our original Alpha line of multi material cutting tools perform as good as or better than dedicated cutting tools from our competitors, on most materials.

Since 2012, we have complemented our offering by adding our Magia line, the highest performance cutting tools available.

Based on innovative tungsten carbide, CVD coating and our globally patented ultra thick hyper pulsed PVD coatings, we reach unparalleled performance.

Lamina continues its fast paced expansion with 7 subsidiaries and representation in over 50 countries.

PROUD SPONSOR OF

SWISS   
TRIATHLON



LAMINA'S DUAL PRODUCT LINE APPROACH

MAGIA

PREMIUM PRODUCT LINE
LT 1000, LT 1005, LT 1025, LT 3000 AND LT 4000
NEW MAGIA PRO LT 3130

- Highest performance grades for top level machining
- Capable of outperforming the best on the market
- For customers that need ultimate performance

ALPHA

STANDARD PRODUCT LINE
LT 10, LT 30 AND LT 40

- Lamina's original, pioneering universal grades
- Excellent performance at attractive price
- Best choice for machine shops with many short product runs and constant changes in workpiece material requiring the highest value for money

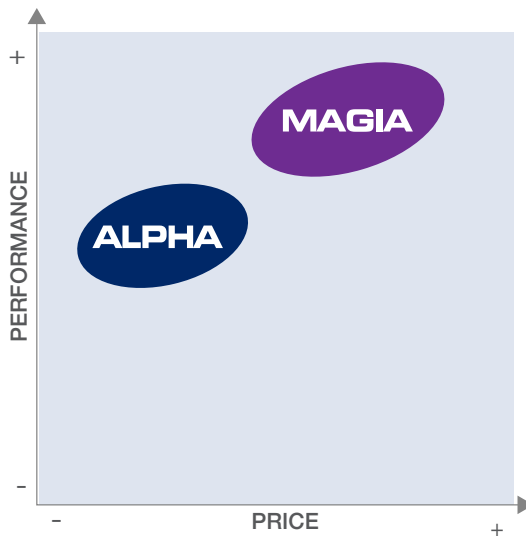

THE MULTI-MAT™ CONCEPT

The Multi-Mat™ Concept was conceived and developed by Lamina Technologies as a consequence of its understanding of the complexities faced by companies in the machining industry.

Through innovative submicron grades and advanced coatings, Lamina has developed a line of products that have excellent performance in wide variety of materials.

WHAT IS MULTI-MAT™?

- A focused range of multi material inserts
- Few grades required for all your machining needs
- Top quality Swiss manufacturing
- Reasonable price



MULTI-MAT™

Simplify your process

Decrease your tooling costs

Minimize your machining down time

Increase your production efficiency



TURNING

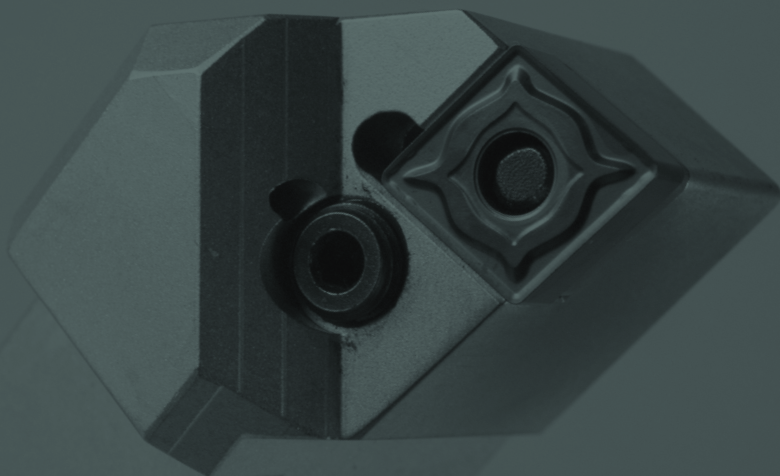



MAGIA TURNING GRADES

CHOOSE THE RIGHT PREMIUM TURNING GRADE

LT 1000

- Submicron PVD Multi-Mat™, the most versatile of our Magia turning grades
- Excellent combination of hardness and toughness
- The first choice for customers with short production runs, different machining applications and different types of workpiece materials

LT 1005

- Submicron, CVD coated grade for P, K & H material groups
- Increased hardness and wear resistance at high temperatures make this grade well suited for stable conditions and higher cutting speeds
- Highly resistant to plastic deformation thus maintaining high dimensional tolerances

LT 1025

- Submicron, CVD coated grade for P, M & K material groups
- Increased toughness makes this grade excellent for unstable conditions, such as interrupted cut
- The low chemical affinity between top ceramic layer and workpiece material ensures low friction and increased resistance to built-up edge development even at low cutting speeds in facing applications



MAGIA TURNING GRADES - LT 10, LT 1000, LT 1005, LT 1025

INSERT DESIGNATION (BASED ON ISO NORMS)



1. Insert Shape

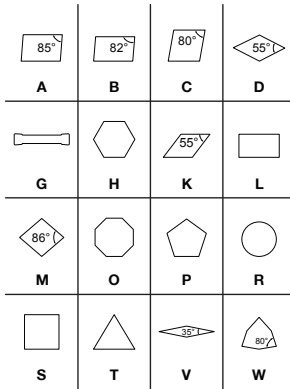

2. Clearance Angle

Letter Symbol	α
A	3°
B	5°
C	7°
D	15°
E	20°
F	25°
G	30°
N	0°
P	11°
O	Special

3. Tolerance Class

Symbol	D	M	S
A	± 0.025	± 0.005	± 0.025
C	± 0.025	± 0.013	± 0.025
E	± 0.025	± 0.025	± 0.025
F	± 0.013	± 0.005	± 0.025
G	± 0.025	± 0.025	± 0.130
H	± 0.013	± 0.013	± 0.025
J*	$\pm 0.05-0.15$	± 0.005	± 0.025
K*	$\pm 0.05-0.15$	± 0.013	± 0.025
L*	$\pm 0.05-0.15$	± 0.025	± 0.025
M*	$\pm 0.05-0.15$	$\pm 0.08-0.20$	± 0.130
N*	$\pm 0.05-0.15$	$\pm 0.08-0.20$	± 0.025
U*	$\pm 0.08-0.25$	$\pm 0.13-0.38$	± 0.130

* Depending on the insert size.

4. Fixing and Chipbreaker Types

Type	Symbol	Type	Symbol
A		N	
B		P	
F		R	
G		T	
H		W	
M		X	Special Design

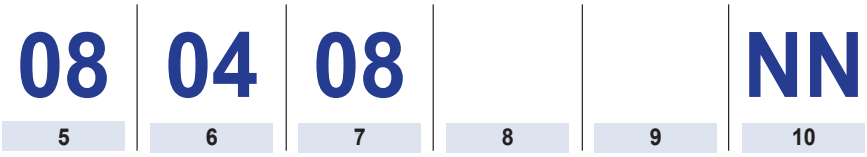

5. Cutting Edge Length

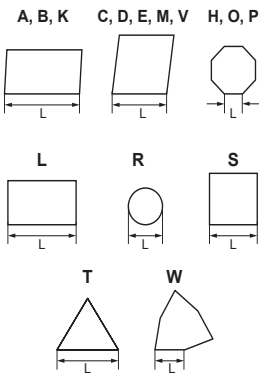

Disregarding any decimals e.g. 12,7 = 12

6. Insert Thickness

Symbol	mm
01	= 1.59
T1	= 1.98
02	= 2.38
03	= 3.18
T3	= 3.97
04	= 4.76
05	= 5.56
06	= 6.35
07	= 7.94
09	= 9.52

7. Insert Corner Radius

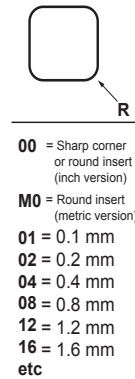

8. Edge Preparation

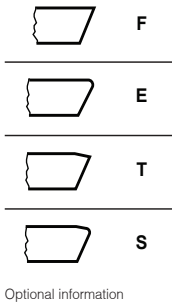

9. Cutting Direction

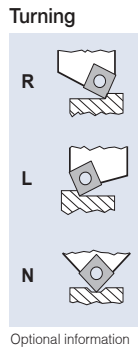

10. Internal Designation



e.g. Chipbreaker (Turning)

NN = General purpose
NM = Roughing operations
NX = General purpose Magia
PP = All purpose grooving
ALU = Non-ferrous materials

Optional information

TURNING

TURNING GRADE RECOMMENDATIONS

Material Group	High Speeds Stable Conditions 	Interrupted Cut Unstable Conditions 	Low Speeds Facing to Center 	Wear Resistance X Toughness
P	<ul style="list-style-type: none"> ▶ LT 1005 LT 1000 LT 1025 	<ul style="list-style-type: none"> LT 1000 ▶ LT 1025 	<ul style="list-style-type: none"> LT 1005 LT 1000 ▶ LT 1025 	<ul style="list-style-type: none"> ↑ Harder ↓ Tougher
M	<ul style="list-style-type: none"> LT 1000 ▶ LT 1025 	<ul style="list-style-type: none"> LT 1000 ▶ LT 1025 	<ul style="list-style-type: none"> LT 1000 ▶ LT 1025 	<ul style="list-style-type: none"> ↑ Harder ↓ Tougher
K	<ul style="list-style-type: none"> ▶ LT 1005 LT 1000 LT 1025 	<ul style="list-style-type: none"> LT 1005 LT 1000 ▶ LT 1025 	<ul style="list-style-type: none"> LT 1005 LT 1000 ▶ LT 1025 	<ul style="list-style-type: none"> ↑ Harder ↓ Tougher
S	<ul style="list-style-type: none"> ▶ LT 1000 	<ul style="list-style-type: none"> ▶ LT 1000 	<ul style="list-style-type: none"> ▶ LT 1000 	<ul style="list-style-type: none"> ↑ Harder ↓ Tougher
H	<ul style="list-style-type: none"> LT 1005 ▶ LT 1000 	<ul style="list-style-type: none"> LT 1005 ▶ LT 1000 	<ul style="list-style-type: none"> LT 1005 ▶ LT 1000 	<ul style="list-style-type: none"> ↑ Harder ↓ Tougher
NF (>8%Si)	<ul style="list-style-type: none"> ▶ LT 1000 	<ul style="list-style-type: none"> ▶ LT 1000 	<ul style="list-style-type: none"> ▶ LT 1000 	<ul style="list-style-type: none"> ↑ Harder ↓ Tougher

▶ 1st choice grade

TURNING GRADE HARDNESS VS TOUGHNESS

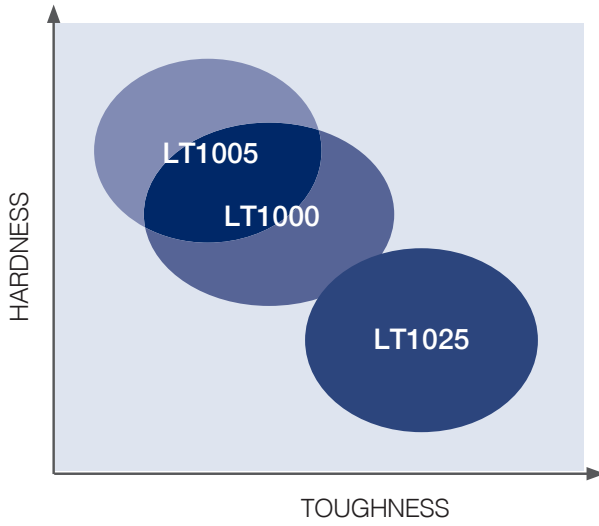

TURNING

TURNING CHIPBREAKER RECOMMENDATIONS

NEGATIVE TURNING CHIPBREAKERS OVERVIEW

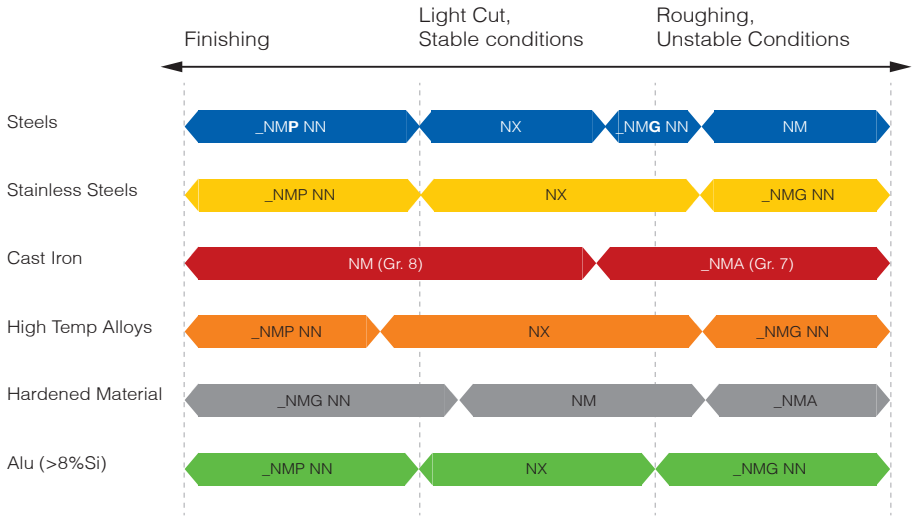

MULTI-MAT™ CHIPBREAKERS

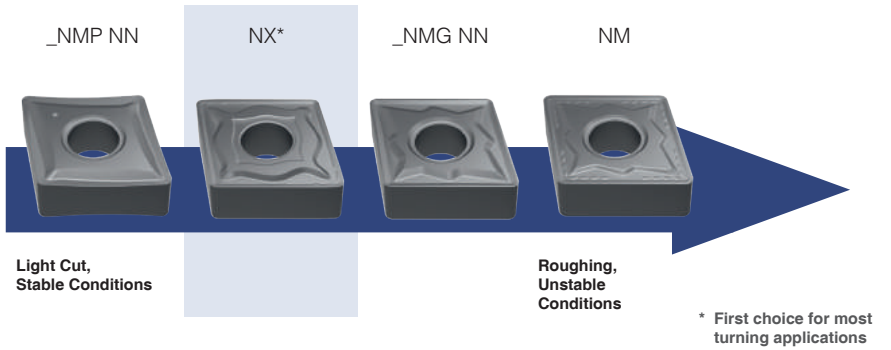

ADDITIONAL DEDICATED GEOMETRIES

_NMA
(Cast Iron Material Group 7)



ALU
(Aluminium <8% Si)

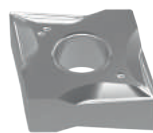

TURNING CHIPBREAKER FRAGMENTATION CHARTS

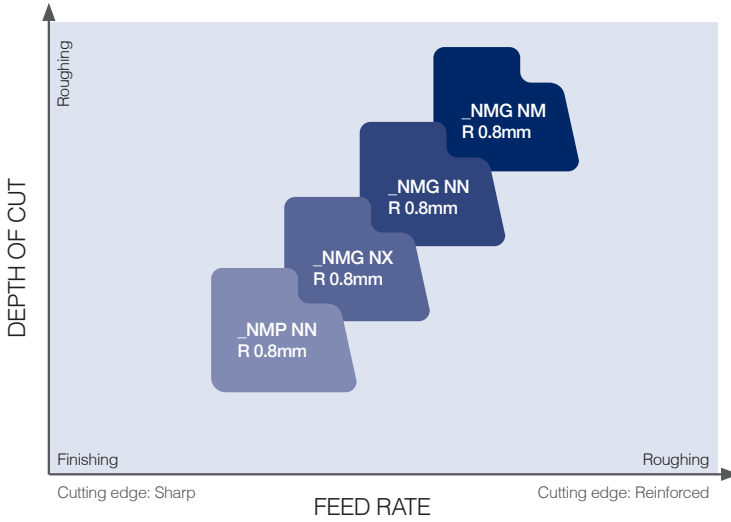
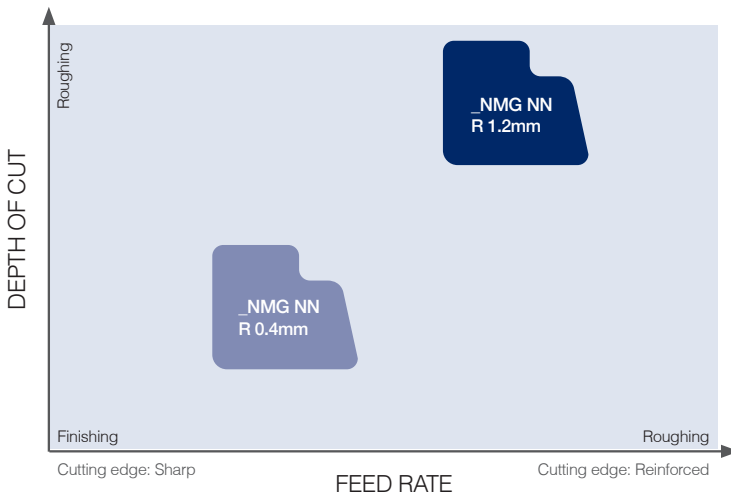
INSERT CORNER RADIUS = 0.8MMINSERT CORNER RADIUS = 0.4 AND 1.2

CCMT



MAGIA

DESIGNATION	GRADE			Vc	PVD/CVD	MATERIAL RECOMMENDATION	CATALOG #
CCMT 060204 NN	LT 1000	●	◐		PVD		T0001888
CCMT 09T304 NN	LT 1000	●	◐		PVD		T0001889
CCMT 09T308 NN	LT 1000	●	◐		PVD		T0001890
CCMT 120404 NN	LT 1000	●	◐		PVD		T0001891
CCMT 120408 NN	LT 1000	●	◐		PVD		T0001892
CCMT 120412 NN	LT 1000	●	◐		PVD		T0001893

ALPHA

DESIGNATION	GRADE			Vc	PVD/CVD	MATERIAL RECOMMENDATION	CATALOG #
CCMT 060204 NN	LT 10	●	◐		PVD		T0000055
CCMT 09T304 NN	LT 10	●	◐		PVD		T0000056
CCMT 09T308 NN	LT 10	●	◐		PVD		T0000117
CCMT 120404 NN	LT 10	●	◐		PVD		T0001456
CCMT 120408 NN	LT 10	●	◐		PVD		T0001457
CCMT 120412 NN	LT 10	●	◐		PVD		T0001776

CNMA

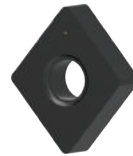

MAGIA

DESIGNATION	GRADE			Vc	PVD/CVD	MATERIAL RECOMMENDATION	CATALOG #
CNMA 120408	LT 1005	●	●		CVD		T0004050
CNMA 120412	LT 1005	●	●		CVD		T0004051

STABLE CONDITIONS
 ● RECOMMENDED
 ◐ ACCEPTABLE
 ○ NOT RECOMMENDED

INTERRUPTED CUT
 ● RECOMMENDED
 ◐ ACCEPTABLE
 ○ NOT RECOMMENDED

Vc RECOMMENDED SPEED
 MODERATE
 LOW TO MODERATE
 MODERATE TO HIGH

ORDERING EXAMPLE
 QUANTITY 10 PIECES
 DESIGNATION + GRADE CCMT 060204 NN LT 1000
 CATALOG NUMBER T0001888

C N M G

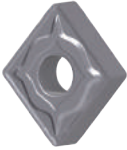

MAGIA

DESIGNATION	GRADE			V _c	PVD/ CVD	MATERIAL RECOMMENDATION	CATALOG #
CNMG 120404 NN	LT 1000	●	◐		PVD		T0001895
CNMG 120408 NX	LT 1000	●	◐		PVD		T0002741
	LT 1005	●	○		CVD		T0004055
	LT 1025	●	●		CVD		T0004113
CNMG 120408 NN	LT 1000	●	◐		PVD		T0001896
	LT 1005	●	○		CVD		T0004054
	LT 1025	●	●		CVD		T0004112
CNMG 120408 NM	LT 1000	●	◐		PVD		T0001968
	LT 1005	●	○		CVD		T0004053
	LT 1025	●	●		CVD		T0004111
CNMG 120412 NN	LT 1000	●	◐		PVD		T0001897
	LT 1005	●	○		CVD		T0004056
	LT 1025	●	●		CVD		T0004114

ALPHA

DESIGNATION	GRADE			V _c	PVD/ CVD	MATERIAL RECOMMENDATION	CATALOG #
CNMG 120404 NN	LT 10	●	◐		PVD		T0000491
CNMG 120408 NN	LT 10	●	◐		PVD		T0000059
CNMG 120408 NM	LT 10	●	◐		PVD		T0001966
CNMG 120412 NN	LT 10	●	◐		PVD		T0000061

MATERIAL GROUP

- STEEL
- HIGH TEMP ALLOYS
- STAINLESS STEEL
- HARDENED MATERIAL
- CAST IRON
- ALU(>8%SI)

COOLANT



CHIPBREAKER



CUTTING SPEED



DOC / FEED



C N M M

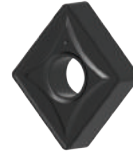

MAGIA

DESIGNATION	GRADE			Vc	PVD/CVD	MATERIAL RECOMMENDATION	CATALOG #
CNMM 120408 NR	LT 1025	●	●		CVD		T0004115
CNMM 120412 NR	LT 1000	●	◐		PVD		T0001899
	LT 1025	●	●		CVD		T0004116

ALPHA

DESIGNATION	GRADE			Vc	PVD/CVD	MATERIAL RECOMMENDATION	CATALOG #
CNMM 120408 NR	LT 10	●	◐		PVD		T0000669
CNMM 120412 NR	LT 10	●	◐		PVD		T0000671

C N M P



MAGIA

DESIGNATION	GRADE			Vc	PVD/CVD	MATERIAL RECOMMENDATION	CATALOG #
CNMP 120408 NN	LT 1000	●	○		PVD		T0001900
	LT 1025	●	○		CVD		T0004117
CNMP 120412 NN	LT 1000	●	○		PVD		T0001901
	LT 1025	●	○		CVD		T0004118

STABLE CONDITIONS
 ● RECOMMENDED
 ◐ ACCEPTABLE
 ○ NOT RECOMMENDED

INTERRUPTED CUT
 ● RECOMMENDED
 ◐ ACCEPTABLE
 ○ NOT RECOMMENDED







Vc RECOMMENDED SPEED
 MODERATE
 LOW TO MODERATE
 MODERATE TO HIGH

ORDERING EXAMPLE
 QUANTITY 10 PIECES
 DESIGNATION + GRADE CCMT 060204 NN LT 1000
 CATALOG NUMBER T0001888

CPMT



MAGIA

DESIGNATION	GRADE			V _c	PVD/ CVD	MATERIAL RECOMMENDATION	CATALOG #
CPMT 060204 NN	LT 1000	●	◐		PVD		T0003088
CPMT 060208 NN	LT 1000	●	◐		PVD		T0003144
CPMT 09T304 NN	LT 1000	●	◐		PVD		T0003145
CPMT 09T308 NN	LT 1000	●	◐		PVD		T0003146

MATERIAL GROUP

	STEEL		HIGH TEMP ALLOYS
	STAINLESS STEEL		HARDENED MATERIAL
	CAST IRON		ALU(>8%Si)

COOLANT



CHIPBREAKER



CUTTING SPEED



DOC / FEED



TURNING



STABLE CONDITIONS

- RECOMMENDED
- ◐ ACCEPTABLE
- NOT RECOMMENDED



INTERRUPTED CUT

- RECOMMENDED
- ◐ ACCEPTABLE
- NOT RECOMMENDED

V_c

RECOMMENDED SPEED

- MODERATE
- LOW TO MODERATE
- MODERATE TO HIGH

ORDERING EXAMPLE

QUANTITY	10 PIECES
DESIGNATION + GRADE	CCMT 060204 NN LT 1000
CATALOG NUMBER	T0001888

DCMT



MAGIA

DESIGNATION	GRADE			Vc	PVD/CVD	MATERIAL RECOMMENDATION	CATALOG #
DCMT 070204 NN	LT 1000	●	◐		PVD		T0001902
DCMT 11T304 NN	LT 1000	●	◐		PVD		T0001903
DCMT 11T308 NN	LT 1000	●	◐		PVD		T0001904

ALPHA

DESIGNATION	GRADE			Vc	PVD/CVD	MATERIAL RECOMMENDATION	CATALOG #
DCMT 070204 NN	LT 10	●	◐		PVD		T0000064
DCMT 11T304 NN	LT 10	●	◐		PVD		T0000065
DCMT 11T308 NN	LT 10	●	◐		PVD		T0000721

DNMA



MAGIA

DESIGNATION	GRADE			Vc	PVD/CVD	MATERIAL RECOMMENDATION	CATALOG #
DNMA 150608	LT 1005	●	●		CVD		T0003241
DNMA 150612	LT 1005	●	●		CVD		T0003242

MATERIAL GROUP

- STEEL
- STAINLESS STEEL
- CAST IRON
- HIGH TEMP ALLOYS
- HARDENED MATERIAL
- ALU(>8%Si)

COOLANT



CHIPBREAKER



CUTTING SPEED



DOC / FEED



DNMG



MAGIA

DESIGNATION	GRADE			V _c	PVD/CVD	MATERIAL RECOMMENDATION	CATALOG #
DNMG 110404 NN	LT 1000	●	◐		PVD		T0001905
DNMG 110408 NN	LT 1000	●	◐		PVD		T0001906
	LT 1005	●	○		CVD		T0004059
	LT 1025	●	●		CVD		T0004119
DNMG 150404 NN	LT 1000	●	◐		PVD		T0001907
DNMG 150408 NX	LT 1000	●	◐		PVD		T0003097
	LT 1005	●	○		CVD		T0004062
	LT 1025	●	●		CVD		T0004122
DNMG 150408 NN	LT 1000	●	◐		PVD		T0001908
	LT 1005	●	○		CVD		T0004061
	LT 1025	●	●		CVD		T0004121
DNMG 150412 NN	LT 1000	●	◐		PVD		T0001909
	LT 1005	●	○		CVD		T0004064
	LT 1025	●	●		CVD		T0004124
DNMG 150604 NN	LT 1000	●	◐		PVD		T0001910
DNMG 150608 NX	LT 1000	●	◐		PVD		T0003220
	LT 1005	●	○		CVD		T0004063
	LT 1025	●	●		CVD		T0004123
DNMG 150608 NN	LT 1000	●	◐		PVD		T0001911
	LT 1005	●	○		CVD		T0004067
	LT 1025	●	●		CVD		T0004126
DNMG 150612 NN	LT 1000	●	◐		PVD		T0001912
	LT 1005	●	○		CVD		T0004068
	LT 1025	●	●		CVD		T0004127

ALPHA

DESIGNATION	GRADE			V _c	PVD/CVD	MATERIAL RECOMMENDATION	CATALOG #
DNMG 110404 NN	LT 10	●	◐		PVD		T0000066
DNMG 110408 NN	LT 10	●	◐		PVD		T0000675
DNMG 150404 NN	LT 10	●	◐		PVD		T0000476
DNMG 150408 NN	LT 10	●	◐		PVD		T0000475
DNMG 150412 NN	LT 10	●	◐		PVD		T0001021
DNMG 150604 NN	LT 10	●	◐		PVD		T0000583
DNMG 150608 NN	LT 10	●	◐		PVD		T0000067
DNMG 150612 NN	LT 10	●	◐		PVD		T0000672

STABLE CONDITIONS
 ● RECOMMENDED
 ◐ ACCEPTABLE
 ○ NOT RECOMMENDED

INTERRUPTED CUT
 ● RECOMMENDED
 ◐ ACCEPTABLE
 ○ NOT RECOMMENDED

V_c RECOMMENDED SPEED
 MODERATE
 LOW TO MODERATE
 MODERATE TO HIGH

ORDERING EXAMPLE
 QUANTITY 10 PIECES
 DESIGNATION + GRADE CCMT 060204 NN LT 1000
 CATALOG NUMBER T0001888

D N U X



MAGIA

DESIGNATION	GRADE			Vc	PVD/CVD	MATERIAL RECOMMENDATION	CATALOG #
DNUX 150608 R11	LT 1000				PVD		T0002793

ALPHA

DESIGNATION	GRADE			Vc	PVD/CVD	MATERIAL RECOMMENDATION	CATALOG #
DNUX 150608 R11	LT 10				PVD		T0002157

MATERIAL GROUP

- STEEL
- STAINLESS STEEL
- CAST IRON
- HIGH TEMP ALLOYS
- HARDENED MATERIAL
- ALU(>8%SI)

COOLANT



CHIPBREAKER



CUTTING SPEED



DOC / FEED



TURNING



STABLE CONDITIONS

- RECOMMENDED
- ◐ ACCEPTABLE
- NOT RECOMMENDED



INTERRUPTED CUT

- RECOMMENDED
- ◐ ACCEPTABLE
- NOT RECOMMENDED

V_c

RECOMMENDED SPEED

- MODERATE
- LOW TO MODERATE
- MODERATE TO HIGH









ORDERING EXAMPLE

QUANTITY	10 PIECES
DESIGNATION + GRADE	CCMT 060204 NN LT 1000
CATALOG NUMBER	T0001888

KNUX



ALPHA

DESIGNATION	GRADE			V _c	PVD/CVD	MATERIAL RECOMMENDATION	CATALOG #
KNUX 160405 L	LT 10				PVD		T0003884
KNUX 160405 R	LT 10				PVD		T0000951

K

MATERIAL GROUP

-  STEEL
-  STAINLESS STEEL
-  CAST IRON
-  HIGH TEMP ALLOYS
-  HARDENED MATERIAL
-  ALU(>8%SI)

COOLANT



CHIPBREAKER



CUTTING SPEED



DOC / FEED



TURNING



STABLE CONDITIONS

- RECOMMENDED
- ◐ ACCEPTABLE
- NOT RECOMMENDED



INTERRUPTED CUT

- RECOMMENDED
- ◐ ACCEPTABLE
- NOT RECOMMENDED

V_c

RECOMMENDED SPEED

- MODERATE
- LOW TO MODERATE
- MODERATE TO HIGH

ORDERING EXAMPLE

QUANTITY	10 PIECES
DESIGNATION + GRADE	CCMT 060204 NN LT 1000
CATALOG NUMBER	T0001888

RCMT



MAGIA

DESIGNATION	GRADE			V _c	PVD/ CVD	MATERIAL RECOMMENDATION	CATALOG #
RCMT 0602 M0	LT 1000	●	◐		PVD		T0001914
RCMT 0803 M0	LT 1000	●	◐		PVD		T0001915
RCMT 10T3 M0	LT 1000	●	◐		PVD		T0001916
RCMT 1204 M0	LT 1000	●	◐		PVD		T0001917

ALPHA

DESIGNATION	GRADE			V _c	PVD/ CVD	MATERIAL RECOMMENDATION	CATALOG #
RCMT 0602 M0	LT 10	●	◐		PVD		T0000090
RCMT 0803 M0	LT 10	●	◐		PVD		T0000091
RCMT 10T3 M0	LT 10	●	◐		PVD		T0000092
RCMT 1204 M0	LT 10	●	◐		PVD		T0000093

R

MATERIAL GROUP

	STEEL		HIGH TEMP ALLOYS
	STAINLESS STEEL		HARDENED MATERIAL
	CAST IRON		ALU(>8%Si)

COOLANT



CHIPBREAKER



CUTTING SPEED



DOC / FEED



TURNING



STABLE CONDITIONS

- RECOMMENDED
- ◐ ACCEPTABLE
- NOT RECOMMENDED



INTERRUPTED CUT

- RECOMMENDED
- ◐ ACCEPTABLE
- NOT RECOMMENDED

V_c

RECOMMENDED SPEED

- MODERATE
- LOW TO MODERATE
- MODERATE TO HIGH

ORDERING EXAMPLE

QUANTITY	10 PIECES
DESIGNATION + GRADE	CCMT 060204 NN LT 1000
CATALOG NUMBER	T0001888

SCMT

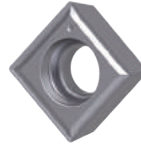

MAGIA

DESIGNATION	GRADE			Vc	PVD/ CVD	MATERIAL RECOMMENDATION	CATALOG #
SCMT 09T304 NN	LT 1000	●	◐		PVD		T0001918
SCMT 09T308 NN	LT 1000	●	◐		PVD		T0001919

ALPHA

DESIGNATION	GRADE			Vc	PVD/ CVD	MATERIAL RECOMMENDATION	CATALOG #
SCMT 09T304 NN	LT 10	●	◐		PVD		T0001459
SCMT 09T308 NN	LT 10	●	◐		PVD		T0001458

SNMA



MAGIA

DESIGNATION	GRADE			Vc	PVD/ CVD	MATERIAL RECOMMENDATION	CATALOG #
SNMA 120408	LT 1005	●	●		CVD		T0003239
SNMA 120412	LT 1005	●	●		CVD		T0003240

S

MATERIAL GROUP

	STEEL		HIGH TEMP ALLOYS
	STAINLESS STEEL		HARDENED MATERIAL
	CAST IRON		ALU(>8%Si)

COOLANT



CHIPBREAKER



CUTTING SPEED



DOC / FEED



SNMG

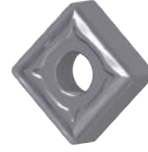

MAGIA

DESIGNATION	GRADE			V _c	PVD/CVD	MATERIAL RECOMMENDATION	CATALOG #
SNMG 120408 NX	LT 1000	●	◐		PVD		T0003011
	LT 1005	●	○		CVD		T0004077
	LT 1025	●	●		CVD		T0004134
SNMG 120408 NN	LT 1000	●	◐		PVD		T0001921
	LT 1005	●	○		CVD		T0004076
	LT 1025	●	●		CVD		T0004133
SNMG 120412 NN	LT 1000	●	◐		PVD		T0001922
	LT 1005	●	○		CVD		T0004078
	LT 1025	●	●		CVD		T0004136

ALPHA

DESIGNATION	GRADE			V _c	PVD/CVD	MATERIAL RECOMMENDATION	CATALOG #
SNMG 120408 NN	LT 10	●	◐		PVD		T0000322
SNMG 120412 NN	LT 10	●	◐		PVD		T0000323

STABLE CONDITIONS
 ● RECOMMENDED
 ◐ ACCEPTABLE
 ○ NOT RECOMMENDED

INTERRUPTED CUT
 ● RECOMMENDED
 ◐ ACCEPTABLE
 ○ NOT RECOMMENDED

V_c RECOMMENDED SPEED
 MODERATE
 LOW TO MODERATE
 MODERATE TO HIGH

ORDERING EXAMPLE
 QUANTITY 10 PIECES
 DESIGNATION + GRADE CCMT 060204 NN LT 1000
 CATALOG NUMBER T0001888

TCMT



MAGIA

DESIGNATION	GRADE			Vc	PVD/CVD	MATERIAL RECOMMENDATION	CATALOG #
TCMT 110204 NN	LT 1000	●	◐		PVD		T0001924
TCMT 110208 NN	LT 1000	●	◐		PVD		T0001925
TCMT 16T304 NN	LT 1000	●	◐		PVD		T0001927
TCMT 16T308 NN	LT 1000	●	◐		PVD		T0001928
TCMT 16T312 NN	LT 1000	●	◐		PVD		T0001929

ALPHA

DESIGNATION	GRADE			Vc	PVD/CVD	MATERIAL RECOMMENDATION	CATALOG #
TCMT 110204 NN	LT 10	●	◐		PVD		T0000477
TCMT 110208 NN	LT 10	●	◐		PVD		T0000478
TCMT 16T304 NN	LT 10	●	◐		PVD		T0000479
TCMT 16T308 NN	LT 10	●	◐		PVD		T0000068
TCMT 16T312 NN	LT 10	●	◐		PVD		T0001774

TNMA



MAGIA

DESIGNATION	GRADE			Vc	PVD/CVD	MATERIAL RECOMMENDATION	CATALOG #
TNMA 160408	LT 1005	●	●		CVD		T0002837
TNMA 160412	LT 1005	●	●		CVD		T0003238



MATERIAL GROUP

- STEEL
- HIGH TEMP ALLOYS
- STAINLESS STEEL
- HARDENED MATERIAL
- CAST IRON
- ALU(>8%SI)

COOLANT



CHIPBREAKER



CUTTING SPEED



DOC / FEED



T N M G

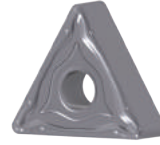

MAGIA

DESIGNATION	GRADE			V _c	PVD/ CVD	MATERIAL RECOMMENDATION	CATALOG #
TNMG 160404 NN	LT 1000	●	◐		PVD		T0001931
TNMG 160408 NX	LT 1000	●	◐		PVD		T0003012
	LT 1005	●	○		CVD		T0004083
	LT 1025	●	●		CVD		T0004139
TNMG 160408 NN	LT 1000	●	◐		PVD		T0001932
	LT 1005	●	○		CVD		T0004082
	LT 1025	●	●		CVD		T0004138
TNMG 160412 NN	LT 1000	●	◐		PVD		T0001933
	LT 1005	●	○		CVD		T0004084
	LT 1025	●	●		CVD		T0004140
TNMG 220404 NN	LT 1000	●	◐		PVD		T0001934
TNMG 220408 NX	LT 1000	●	◐		PVD		T0003013
	LT 1005	●	○		CVD		T0004087
	LT 1025	●	●		CVD		T0004143
TNMG 220408 NN	LT 1000	●	◐		PVD		T0001935
	LT 1005	●	○		CVD		T0004086
	LT 1025	●	●		CVD		T0004142
TNMG 220412 NN	LT 1000	●	◐		PVD		T0001936
	LT 1005	●	○		CVD		T0004088
	LT 1025	●	●		CVD		T0004144

ALPHA

DESIGNATION	GRADE			V _c	PVD/ CVD	MATERIAL RECOMMENDATION	CATALOG #
TNMG 160404 NN	LT 10	●	◐		PVD		T0000457
TNMG 160408 NN	LT 10	●	◐		PVD		T0000069
TNMG 160412 NN	LT 10	●	◐		PVD		T0001734
TNMG 220404 NN	LT 10	●	◐		PVD		T0001873
TNMG 220408 NN	LT 10	●	◐		PVD		T0000113
TNMG 220412 NN	LT 10	●	◐		PVD		T0001735

STABLE CONDITIONS
 ● RECOMMENDED
 ◐ ACCEPTABLE
 ○ NOT RECOMMENDED

INTERRUPTED CUT
 ● RECOMMENDED
 ◐ ACCEPTABLE
 ○ NOT RECOMMENDED

V_c RECOMMENDED SPEED
 MODERATE
 LOW TO MODERATE
 MODERATE TO HIGH

ORDERING EXAMPLE
 QUANTITY 10 PIECES
 DESIGNATION + GRADE CCMT 060204 NN LT 1000
 CATALOG NUMBER T0001888

T N M P

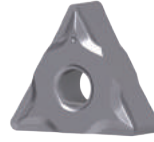

MAGIA

DESIGNATION	GRADE			V _c	PVD/ CVD	MATERIAL RECOMMENDATION	CATALOG #
TNMP 160408 NN	LT 1000	●	○		PVD		T0001937
	LT 1025	●	○		CVD		T0004145

ALPHA

DESIGNATION	GRADE			V _c	PVD/ CVD	MATERIAL RECOMMENDATION	CATALOG #
TNMP 160408 NN	LT 10	●	○		PVD		T0000492

T N U X



MAGIA

DESIGNATION	GRADE			V _c	PVD/ CVD	MATERIAL RECOMMENDATION	CATALOG #
TNUX 160404 L	LT 1000	●	○		PVD		T0002794
TNUX 160404 R	LT 1000	●	○		PVD		T0001938
TNUX 160408 L	LT 1000	●	◐		PVD		T0002795
TNUX 160408 R	LT 1000	●	◐		PVD		T0001939

ALPHA

DESIGNATION	GRADE			V _c	PVD/ CVD	MATERIAL RECOMMENDATION	CATALOG #
TNUX 160404 L	LT 10	●	○		PVD		T0001877
TNUX 160404 R	LT 10	●	○		PVD		T0001125
TNUX 160408 L	LT 10	●	◐		PVD		T0003385
TNUX 160408 R	LT 10	●	◐		PVD		T0001137

MATERIAL GROUP

	STEEL		HIGH TEMP ALLOYS
	STAINLESS STEEL		HARDENED MATERIAL
	CAST IRON		ALU(>8%Si)

COOLANT



CHIPBREAKER



CUTTING SPEED



DOC / FEED



TPMR



ALPHA

DESIGNATION	GRADE			V _c	PVD/ CVD	MATERIAL RECOMMENDATION	CATALOG #
TPMR 160304 NN	LT 10	●	◐		PVD		T0001638
TPMR 160308 NN	LT 10	●	◐		PVD		T0001535

STABLE CONDITIONS
 ● RECOMMENDED
 ◐ ACCEPTABLE
 ○ NOT RECOMMENDED

INTERRUPTED CUT
 ● RECOMMENDED
 ◐ ACCEPTABLE
 ○ NOT RECOMMENDED

V_c RECOMMENDED SPEED
 MODERATE
 LOW TO MODERATE
 MODERATE TO HIGH

ORDERING EXAMPLE
QUANTITY 10 PIECES
DESIGNATION + GRADE CCMT 060204 NN LT 1000
CATALOG NUMBER T0001888

V B M T



MAGIA

DESIGNATION	GRADE			V _c	PVD/ CVD	MATERIAL RECOMMENDATION	CATALOG #
VBMT 110304 NN	LT 1000	●	◐		PVD		T0001942
VBMT 160404 NN	LT 1000	●	◐		PVD		T0001943
VBMT 160408 NN	LT 1000	●	◐		PVD		T0001944

ALPHA

DESIGNATION	GRADE			V _c	PVD/ CVD	MATERIAL RECOMMENDATION	CATALOG #
VBMT 110304 NN	LT 10	●	◐		PVD		T0001460
VBMT 160404 NN	LT 10	●	◐		PVD		T0000070
VBMT 160408 NN	LT 10	●	◐		PVD		T0000071

V C M T



MAGIA

DESIGNATION	GRADE			V _c	PVD/ CVD	MATERIAL RECOMMENDATION	CATALOG #
VCMT 160404 NN	LT 1000	●	◐		PVD		T0001945
VCMT 160408 NN	LT 1000	●	◐		PVD		T0001946

ALPHA

DESIGNATION	GRADE			V _c	PVD/ CVD	MATERIAL RECOMMENDATION	CATALOG #
VCMT 160404 NN	LT 10	●	◐		PVD		T0001102
VCMT 160408 NN	LT 10	●	◐		PVD		T0001103

MATERIAL GROUP

	STEEL		HIGH TEMP ALLOYS
	STAINLESS STEEL		HARDENED MATERIAL
	CAST IRON		ALU(>8%Si)

COOLANT



CHIPBREAKER



CUTTING SPEED



DOC / FEED



V N M G



MAGIA

DESIGNATION	GRADE			V _c	PVD/ CVD	MATERIAL RECOMMENDATION	CATALOG #
VNMG 160404 NN	LT 1000	●	◐		PVD		T0001947
VNMG 160408 NN	LT 1000	●	◐		PVD		T0001948
	LT 1005	●	○		CVD		T0004095
	LT 1025	●	●		CVD		T0004149

ALPHA

DESIGNATION	GRADE			V _c	PVD/ CVD	MATERIAL RECOMMENDATION	CATALOG #
VNMG 160404 NN	LT 10	●	◐		PVD		T0000072
VNMG 160408 NN	LT 10	●	◐		PVD		T0000073

STABLE CONDITIONS
 ● RECOMMENDED
 ◐ ACCEPTABLE
 ○ NOT RECOMMENDED

INTERRUPTED CUT
 ● RECOMMENDED
 ◐ ACCEPTABLE
 ○ NOT RECOMMENDED





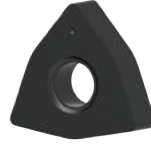

V_c RECOMMENDED SPEED
 MODERATE
 LOW TO MODERATE
 MODERATE TO HIGH

ORDERING EXAMPLE
QUANTITY 10 PIECES
DESIGNATION + GRADE CCMT 060204 NN LT 1000
CATALOG NUMBER T0001888

WNMA



MAGIA

DESIGNATION	GRADE			V _c	PVD/ CVD	MATERIAL RECOMMENDATION	CATALOG #
WNMA 080408	LT 1005	●	●		CVD	 	T0002840
WNMA 080412	LT 1005	●	●		CVD		T0002841



MATERIAL GROUP

 STEEL	 HIGH TEMP ALLOYS
 STAINLESS STEEL	 HARDENED MATERIAL
 CAST IRON	 ALU(>8%Si)

COOLANT



CHIPBREAKER



CUTTING SPEED



DOC / FEED



W N M G

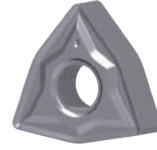

MAGIA

DESIGNATION	GRADE			V _c	PVD/ CVD	MATERIAL RECOMMENDATION	CATALOG #
WNMG 060404 NN	LT 1000	●	◐		PVD		T0001949
WNMG 060408 NX	LT 1000	●	◐		PVD		T0003014
	LT 1005	●	○		CVD		T0004100
	LT 1025	●	○		CVD		T0004151
WNMG 060408 NN	LT 1000	●	◐		PVD		T0001950
	LT 1005	●	○		CVD		T0004099
	LT 1025	●	●		CVD		T0004150
WNMG 080404 NN	LT 1000	●	◐		PVD		T0001951
WNMG 080408 NX	LT 1000	●	◐		PVD		T0002742
	LT 1005	●	○		CVD		T0004104
	LT 1025	●	●		CVD		T0004155
WNMG 080408 NN	LT 1000	●	◐		PVD		T0001952
	LT 1005	●	○		CVD		T0004103
	LT 1025	●	●		CVD		T0004154
WNMG 080408 NM	LT 1000	●	◐		PVD		T0001969
	LT 1005	●	○		CVD		T0004102
	LT 1025	●	●		CVD		T0004153
WNMG 080412 NN	LT 1000	●	◐		PVD		T0001953
	LT 1005	●	○		CVD		T0004105
	LT 1025	●	●		CVD		T0004156

STABLE CONDITIONS
 ● RECOMMENDED
 ◐ ACCEPTABLE
 ○ NOT RECOMMENDED









INTERRUPTED CUT
 ● RECOMMENDED
 ◐ ACCEPTABLE
 ○ NOT RECOMMENDED

V_c RECOMMENDED SPEED
 MODERATE
 LOW TO MODERATE
 MODERATE TO HIGH

ORDERING EXAMPLE
 QUANTITY 10 PIECES
 DESIGNATION + GRADE CCMT 060204 NN LT 1000
 CATALOG NUMBER T0001888

W N M G

ALPHA

DESIGNATION	GRADE			V _c	PVD/ CVD	MATERIAL RECOMMENDATION	CATALOG #
WNMG 060404 NN	LT 10	●	◐		PVD		T0000133
WNMG 060408 NN	LT 10	●	◐		PVD		T0000137
WNMG 080404 NN	LT 10	●	◐		PVD		T0000584
WNMG 080408 NN	LT 10	●	◐		PVD		T0000075
WNMG 080408 NM	LT 10	●	◐		PVD		T0001967
WNMG 080412 NN	LT 10	●	◐		PVD		T0000077

MATERIAL GROUP

	STEEL		HIGH TEMP ALLOYS
	STAINLESS STEEL		HARDENED MATERIAL
	CAST IRON		ALU(>8%SI)

COOLANT



CHIPBREAKER



CUTTING SPEED



DOC / FEED



W N M P

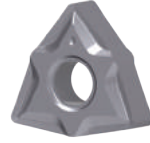

MAGIA

DESIGNATION	GRADE			V _c	PVD/CVD	MATERIAL RECOMMENDATION	CATALOG #
WNMP 060404 NN	LT 1000	●	○		PVD		T0001954
WNMP 060408 NN	LT 1000	●	○		PVD		T0001955
WNMP 080408 NN	LT 1000	●	○		PVD		T0001956
	LT 1005	●	○		CVD		T0004106
	LT 1025	●	○		CVD		T0004157

ALPHA

DESIGNATION	GRADE			V _c	PVD/CVD	MATERIAL RECOMMENDATION	CATALOG #
WNMP 060404 NN	LT 10	●	○		PVD		T0000306
WNMP 060408 NN	LT 10	●	○		PVD		T0000307
WNMP 080408 NN	LT 10	●	○		PVD		T0000308

MATERIAL GROUP

- | | | | |
|--|-----------------|--|-------------------|
| | STEEL | | HIGH TEMP ALLOYS |
| | STAINLESS STEEL | | HARDENED MATERIAL |
| | CAST IRON | | ALU(>8%Si) |

COOLANT



CHIPBREAKER



CUTTING SPEED



DEPTH OF CUT



- | | | | |
|---|-------------------|---|-----------------|
| | STABLE CONDITIONS | | INTERRUPTED CUT |
| ● | RECOMMENDED | ● | RECOMMENDED |
| ◐ | ACCEPTABLE | ◐ | ACCEPTABLE |
| ○ | NOT RECOMMENDED | ○ | NOT RECOMMENDED |

- | | |
|--|-------------------|
| | RECOMMENDED SPEED |
| | MODERATE |
| | LOW TO MODERATE |
| | MODERATE TO HIGH |

- ORDERING EXAMPLE
- | | |
|----------------------------|------------------------|
| QUANTITY | 10 PIECES |
| DESIGNATION + GRADE | CCMT 060204 NN LT 1000 |
| CATALOG NUMBER | T0001888 |

ALU TURNING

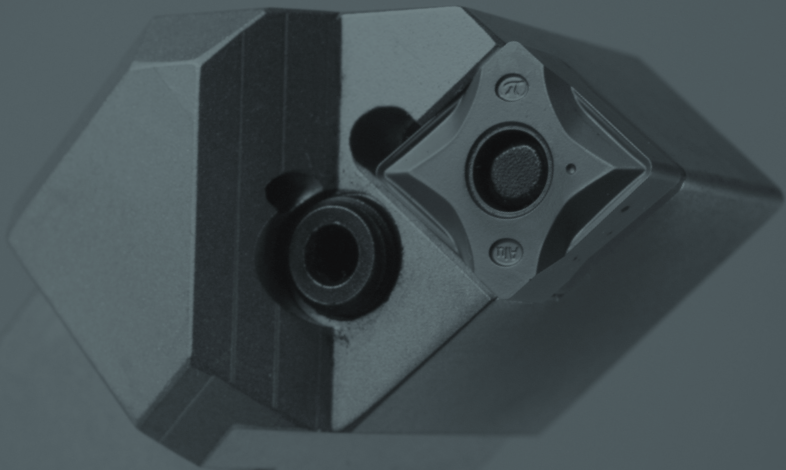

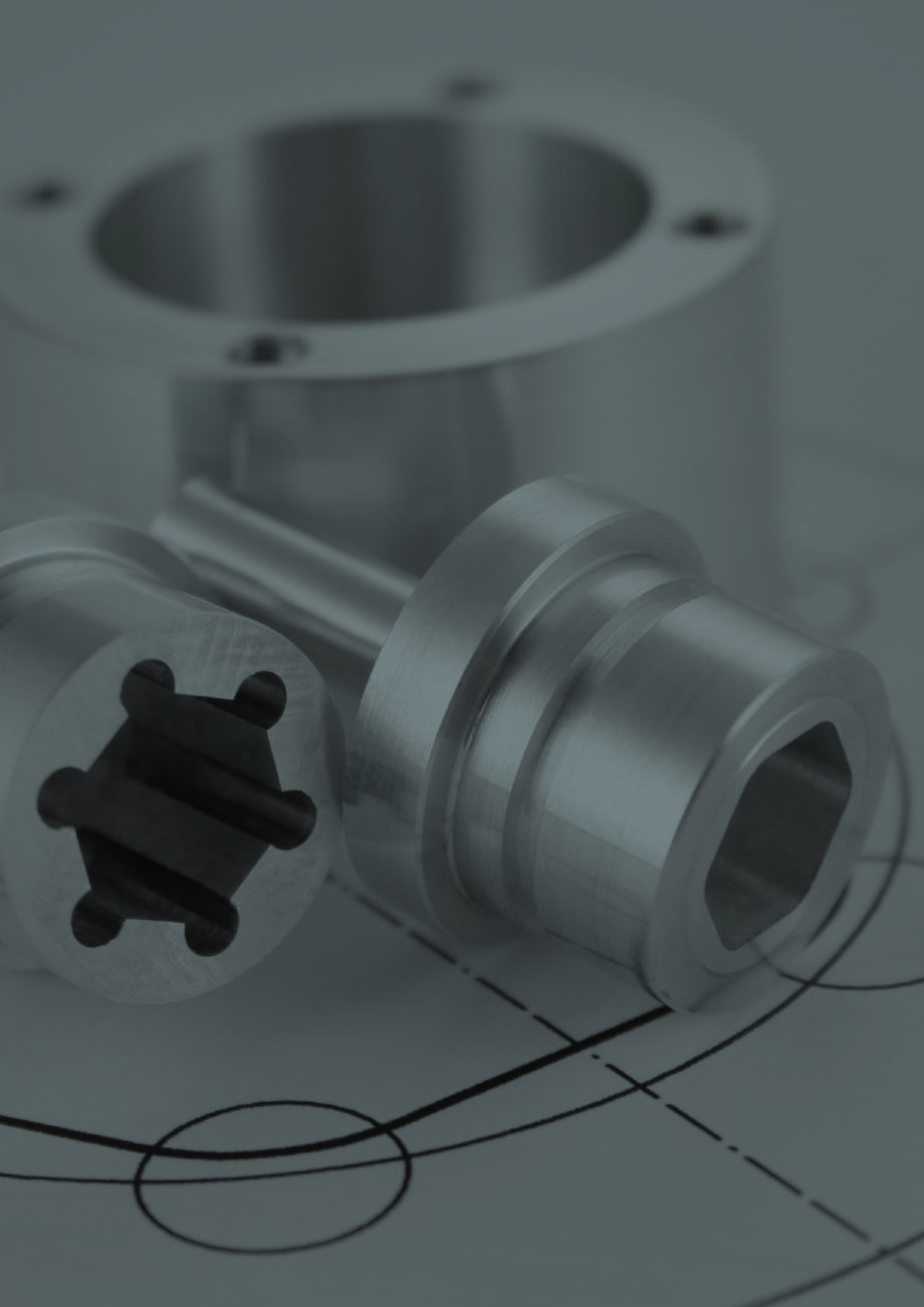

LT 05 ALUMINIUM GRADE

- Dedicated for aluminum and other non-ferrous materials
- Low friction
- High resistance to built up edge
- Extremely long tool life

ISO standard positive chipbreaker geometries for aluminium turning operations.

- Improved chip control and chip evacuation
- Standard 2 cutting edges
- Economical 4 cutting edges
- All inserts use standard tool holders and boring bars

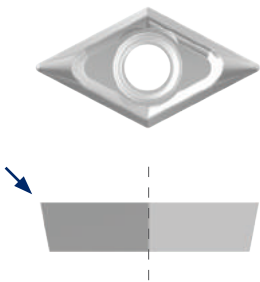

STANDARD POSITIVE INSERTS
_CGT

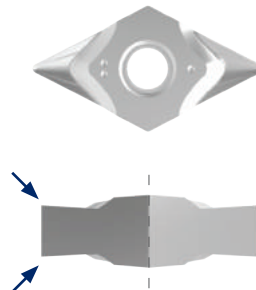

LAMINA 4 EDGE ALTERNATIVE
_NGG

CCGT



DESIGNATION	GRADE	MATERIAL RECOMMENDATION	CATALOG #
CCGT 060204 ALU	LT 05		T0004162
CCGT 09T304 ALU	LT 05		T0004163

CNNG



DESIGNATION	GRADE	MATERIAL RECOMMENDATION	CATALOG #
CNNG 09T304 ALU	LT 05		T0003298
CNNG 120404 ALU	LT 05		T0001025
CNNG 120408 ALU	LT 05		T0001019

DCGT



DESIGNATION	GRADE	MATERIAL RECOMMENDATION	CATALOG #
DCGT 11T304 ALU	LT 05		T0004164

DNNG



DESIGNATION	GRADE	MATERIAL RECOMMENDATION	CATALOG #
DNNG 110404 ALU	LT 05		T0001026
DNNG 110408 ALU	LT 05		T0001010

MATERIAL GROUP

- STEEL
- STAINLESS STEEL
- CAST IRON
- HIGH TEMP ALLOYS
- HARDENED MATERIAL
- ALU(>8%Si)

CUTTING SPEED



DEPTH OF CUT



ORDERING EXAMPLE

- QUANTITY 10 PIECES
- DESIGNATION + GRADE CCMT 060204 NN LT 1000
- CATALOG NUMBER T0001888

T N G G



DESIGNATION	GRADE	MATERIAL RECOMMENDATION	CATALOG #
TNGG 160404 ALU	LT 05		T0001105

V N G G



DESIGNATION	GRADE	MATERIAL RECOMMENDATION	CATALOG #
VNGG 160404 ALU	LT 05		T0001006
VNGG 160408 ALU	LT 05		T0001032

W N G G



DESIGNATION	GRADE	MATERIAL RECOMMENDATION	CATALOG #
WNGG 060404 ALU	LT 05		T0003299
WNGG 080404 ALU	LT 05		T0003300

MATERIAL GROUP

- STEEL
- STAINLESS STEEL
- CAST IRON
- HIGH TEMP ALLOYS
- HARDENED MATERIAL
- ALU(>8%Si)

CUTTING SPEED



DOC / FEED



ORDERING EXAMPLE

QUANTITY 10 PIECES
 DESIGNATION + GRADE CCMT 060204 NN LT 1000
 CATALOG NUMBER T0001888

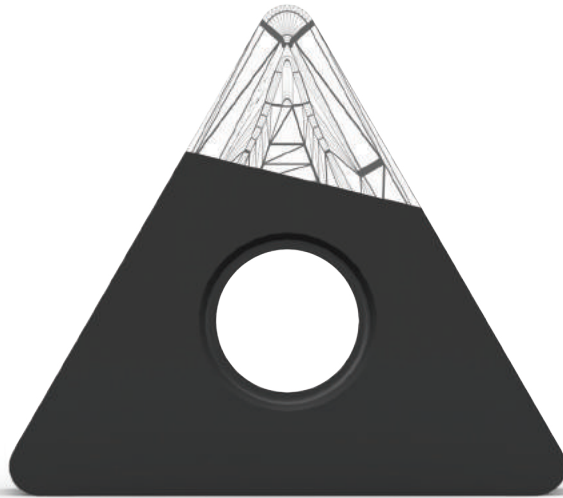

MADE IN SWITZERLAND



PARTING & GROOVING



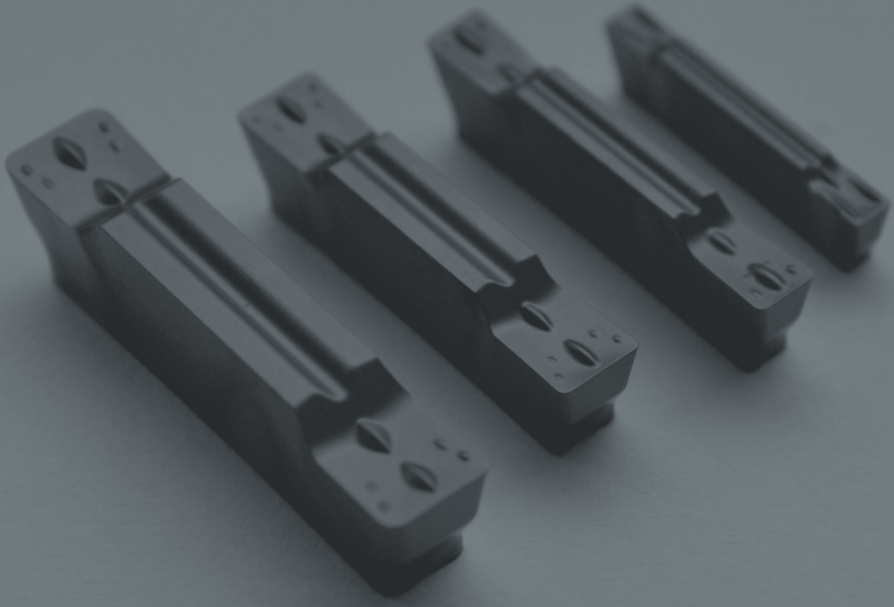

PARTING AND GROOVING

MULTI-MAT™ PARTING INSERTS AND TOOLS FOR MULTIPLE APPLICATIONS

Our Swiss quality, precision made parting and grooving inserts are designed for efficient and trouble free application in a wide variety of materials.

- Universal grade for long tool life in numerous workpiece materials
- ISO standard blocks and blades

GCTX



MAGIA

DESIGNATION	GRADE	W	R	MATERIAL RECOMMENDATION	CATALOG #
GCTX 2002 NN	LT 1000	2.00	0.18		T0002825
GCTX 3003 NN	LT 1000	3.00	0.25		T0002826
GCTX 3003 PP	LT 1000	3.00	0.25		T0002828

MGMN

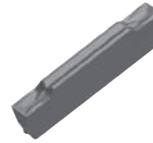

ALPHA

DESIGNATION	GRADE	W	R	MATERIAL RECOMMENDATION	CATALOG #
MGMN 200 G	LT 10	2.00	0.2		T0003909
MGMN 300 M	LT 10	3.00	0.4		T0003910
MGMN 400 M	LT 10	4.00	0.4		T0003911
MGMN 500 M	LT 10	5.00	0.8		T0003921

WGE

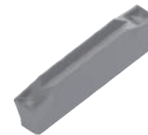

ALPHA

DESIGNATION	GRADE	W	R	MATERIAL RECOMMENDATION	CATALOG #
WGE 2000	LT 10	2.00	0.2		T0003932
WGE 3000	LT 10	3.00	0.4		T0003933
WGE 4000	LT 10	4.00	0.4		T0003934
WGE 5000	LT 10	5.00	0.8		T0003935

CUTTING SPEED



p. 284

DOC / FEED



p. 285 - 287

PARTING AND GROOVING TOOL HOLDERS

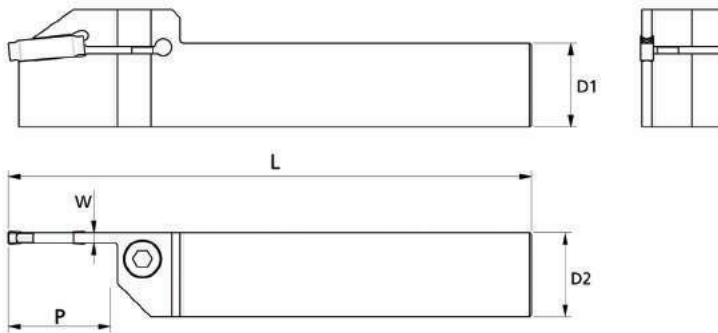

GCTX 2002

DESIGNATION	D	D2	L	W	Pmax	HAND	CATALOG #
LT PNG-L 12-2.0	12	12	120	1.6	15	LEFT	T2001164
LT PNG-R 12-2.0	12	12	120	1.6	15	RIGHT	T2001165
LT PNG-L 16-2.0	16	16	120	1.6	15	LEFT	T2001166
LT PNG-R 16-2.0	16	16	120	1.6	15	RIGHT	T2001167
LT PNG-L 20-2.0	20	20	120	1.6	15	LEFT	T2001484
LT PNG-R 20-2.0	20	20	120	1.6	15	RIGHT	T2001485
LT PNG-L 25-2.0	25	25	120	1.6	15	LEFT	T2001482
LT PNG-R 25-2.0	25	25	120	1.6	15	RIGHT	T2001483

SCREW M2001797
KEY M2000609

GCTX 3003

DESIGNATION	D	Dmin	L	W	Pmax	HAND	CATALOG #
LT PNG-L 16-3.0	16	16	120	2.4	15	LEFT	T2001168
LT PNG-R 16-3.0	16	16	120	2.4	15	RIGHT	T2001169
LT PNG-L 20-3.0	20	20	125	2.4	15	LEFT	T2001170
LT PNG-R 20-3.0	20	20	125	2.4	15	RIGHT	T2001171
LT PNG-L 25-3.0	25	25	125	2.4	15	LEFT	T2001197
LT PNG-R 25-3.0	25	25	125	2.4	15	RIGHT	T2001198

SCREW M2001797
KEY M2000609

PARTING & GROOVING

BLADES AND BLOCKS

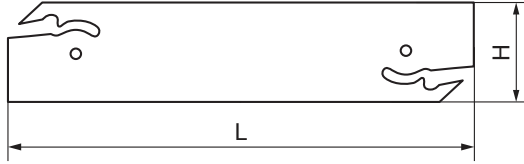

GCTX 3003

DESIGNATION	L	H	-	-	-	-	CATALOG #
LT BNG-32-3	32	32	-	-	-	-	T2002751

KEY T2002761

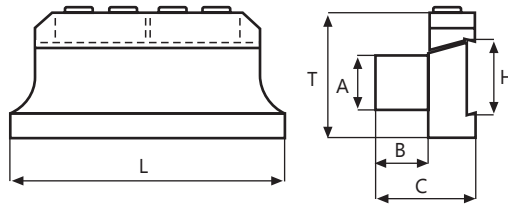

BLOCKS

DESIGNATION	H	A	B	C	L	T	CATALOG #
LT PNB-N 2020-32	32	20	19	38	120	48	T2002762
LT PNB-N 2525-32	32	25	23	42	120	48	T2002763

SCREW T2002785
KEY T2002786

THREAD TURNING

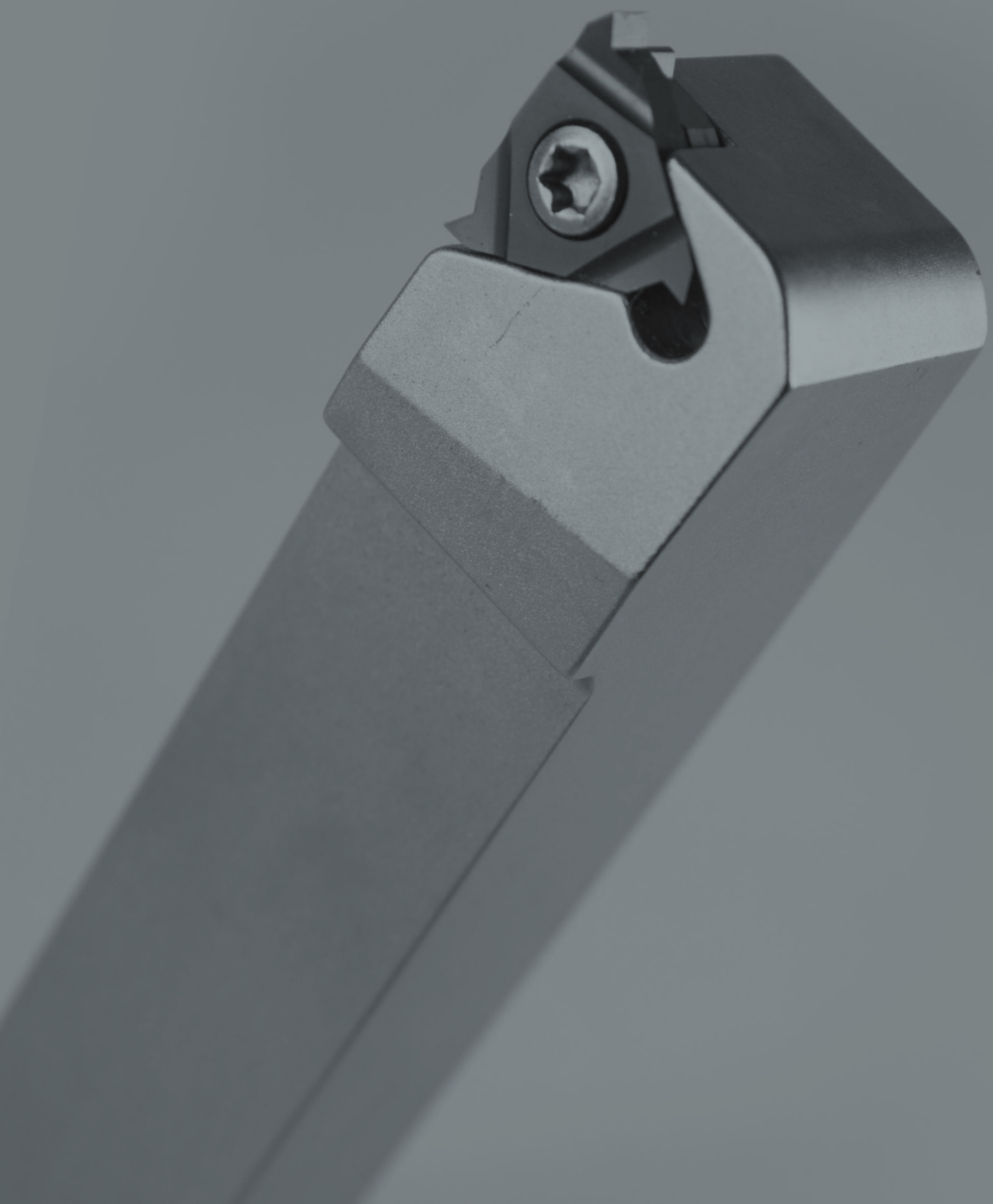



THREAD TURNING

MULTI-MAT™ INTERNAL AND EXTERNAL THREADING INSERTS

Our threading inserts offer superior tool life and versatility in a range of materials.

We offer a broad selection of triangular thread turning inserts and tool-holders for external and internal threads and a variety of thread standards.

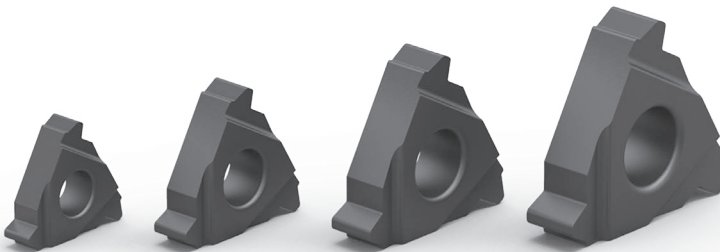

THREAD TURNING

INSERT ORDERING CODE

ISO	0.5	ER	16
------------	------------	-----------	-----------

PROFILE	PITCH			TYPE OF INSERT	INSERT SIZE	
	SHAPE	mm	TPI		L	I.C.
PARTIAL PROFILE 60°, 55°	A	0.5 - 1.5	48 - 16	ER External right handed	06	4.0
	G	1.75 - 3.0	14 - 8		08	5.0
	FULL PROFILE ISO METRIC, BSPT, NPT, UN, TRAPEZ, WITHWORTH	AG	0.5 - 3.0	48 - 8	EL External left handed	11
N		3.5 - 5.0	7 - 5	IR Internal right handed	16	9.5
Q		5.5 - 6.0	4.5 - 4		22	12.7
Full Profile			IL Internal left handed	27	15.8	
-	3.5 - 6.0	72 - 4				

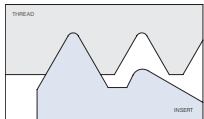
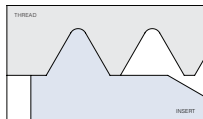
PARTIAL (A,G,AG,N,Q)	FULL
	
<ul style="list-style-type: none"> • Most economical solution • Used for wide range of pitches • It is partial because the exterior major or internal minor diameter is not machined 	<ul style="list-style-type: none"> • Cuts all thread shapes according to the requirements • Wide range of inserts needed in order to fit each standard and range of pitches

TOOL HOLDER ORDERING CODE

HER	2525	M	16
------------	-------------	----------	-----------

HOLDER TYPE	SHANK	TOOL LENGTH		INSERT SIZE	
				L	I.C.
HER External right handed	External Tool holders Square Shank:	H	100	L	L
		K	125	06	4.0
HEL External left handed	8, 10, 12, 16, 20, 25, 32	L	140	08	5.0
		M	150	11	6.3
HIR Internal right handed	Internal Tool holders Round Shank:	P	170	16	9.5
		R	200	22	12.7
HIL Internal left handed	10, 12, 16, 20, 25, 32, 40	S	250	27	15.8
		T	300		

PARTIAL PROFILE 60°

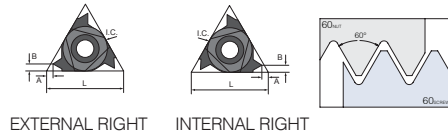

DESIGNATION	GRADE	PITCH RANGE		DIMENSIONS				CATALOG #
		mm	TPI	L mm	I.C.	A	B	
EXTERNAL								
A60 ER16	LT 10	0.5 - 1.5	48 - 16	16	9.5	0.8	0.9	TH000004
G60 ER16	LT 10	1.75 - 3.0	14 - 8	16	9.5	1.2	1.7	TH000010
AG60 ER16	LT 10	0.5 - 3.0	48 - 8	16	9.5	1.2	1.7	TH000016
N60 ER 22	LT 10	3.5 - 5.0	7 - 5	22	12.7	1.7	2.5	TH000116
INTERNAL								
A60 IR11	LT 10	0.5 - 1.5	48 - 16	11	6.3	0.8	0.9	TH000001
A60 IR16	LT 10	0.5 - 1.5	48 - 16	16	9.5	0.8	0.9	TH000007
G60 IR16	LT 10	1.75 - 3.0	14 - 8	16	9.5	1.2	1.7	TH000013
AG60 IR16	LT 10	0.5 - 3.0	48 - 8	16	9.5	1.2	1.7	TH000019
N60 IR 22	LT 10	3.5 - 5.0	7 - 5	22	12.7	1.7	2.5	TH000119

PARTIAL PROFILE 55°

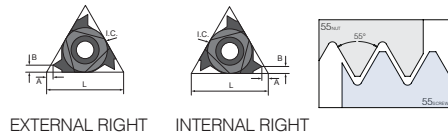

DESIGNATION	GRADE	PITCH RANGE		DIMENSIONS				CATALOG #
		mm	TPI	L mm	I.C.	A	B	
EXTERNAL								
AG55 ER16	LT 10	0.5 - 3.0	48 - 8	16	9.5	1.2	1.7	TH000022
N55 ER22	LT 10	3.5 - 5.0	7 - 5	22	12.7	1.7	2.5	TH000120
INTERNAL								
AG55 IR16	LT 10	0.5 - 3.0	48 - 8	16	9.5	1.2	1.7	TH000025
N55 IR22	LT 10	3.5 - 5.0	7 - 5	22	12.7	1.7	2.5	TH000121



BSPT

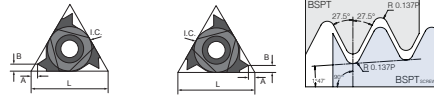

EXTERNAL RIGHT INTERNAL RIGHT B.S. 21: 1985

DESIGNATION	GRADE	TPI	DIMENSIONS				CATALOG #
			L mm	I.C.	A	B	
EXTERNAL							
BSPT11 ER16	LT 10	11	16	9.525	1.1	1.5	TH000138
BSPT14 ER16	LT 10	14	16	9.525	1.0	1.2	TH000137
BSPT19 ER16	LT 10	19	16	9.525	0.8	0.9	TH000136
INTERNAL							
BSPT11 IR16	LT 10	11	16	9.525	1.1	1.5	TH000141
BSPT14 IR16	LT 10	14	16	9.525	1.0	1.2	TH000140
BSPT19 IR16	LT 10	19	16	9.525	0.8	0.9	TH000139

NPT

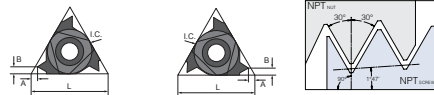

EXTERNAL RIGHT INTERNAL RIGHT ANSI/ASME B 1.20.1-1983

DESIGNATION	GRADE	TPI	DIMENSIONS				CATALOG #
			L mm	I.C.	A	B	
EXTERNAL							
NPT 8 ER16	LT 10	8	16	9.525	1.3	1.8	TH000145
NPT 11.5 ER16	LT 10	11.5	16	9.525	1.1	1.5	TH000144
NPT 14 ER16	LT 10	14	16	9.525	0.9	1.2	TH000143
NPT 18 ER16	LT 10	18	16	9.525	0.8	1.0	TH000142
INTERNAL							
NPT 8 IR16	LT 10	8	16	9.525	1.3	1.8	TH000148
NPT 11.5 IR16	LT 10	11.5	16	9.525	1.1	1.5	TH000147
NPT 14 IR16	LT 10	14	16	9.525	0.9	1.2	TH000146



UN

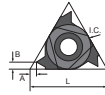

EXTERNAL RIGHT

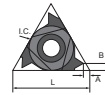

INTERNAL RIGHT

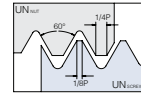

ANSI B1.1-1982

DESIGNATION	GRADE	TPI	DIMENSIONS				CATALOG #
			L mm	I.C.	A	B	
EXTERNAL							
UN 12 ER16	LT 10	20	16	9.525	0.8	0.9	TH000088
UN 16 ER16	LT 10	16	16	9.525	0.9	1.1	TH000082
UN 20 ER16	LT 10	12	16	9.525	1.1	1.4	TH000076
INTERNAL							
UN 12 IR16	LT 10	20	16	9.525	0.8	0.9	TH000091
UN 16 IR16	LT 10	16	16	9.525	0.9	1.1	TH000085
UN 20 IR16	LT 10	12	16	9.525	1.1	1.4	TH000079

TRAPEZ

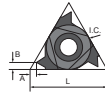

EXTERNAL RIGHT

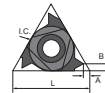

INTERNAL RIGHT

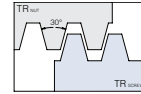

DIN 103:1977
ISO 2901:1993

DESIGNATION	GRADE	PITCH mm	DIMENSIONS				CATALOG #
			L mm	I.C.	A	B	
EXTERNAL							
TR 3.0 ER16	LT 10	3.00	16	9.525	1.3	1.5	TH000149
TR 4.0 ER22	LT 10	4.00	22	12.70	1.7	1.9	TH000150
INTERNAL							
TR 3.0 IR16	LT 10	3.00	16	9.525	1.3	1.5	TH000151
TR 4.0 IR22	LT 10	4.00	22	12.70	1.7	1.9	TH000152



WHITWORTH

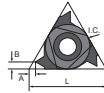

EXTERNAL RIGHT

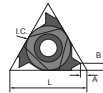

INTERNAL RIGHT

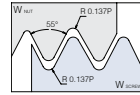

B.S.84: 1956
ISO228-1: 1994

DESIGNATION	GRADE	TPI	DIMENSIONS				CATALOG #
			L mm	I.C.	A	B	
EXTERNAL							
W 11 ER16	LT 10	11	16	9.525	1.1	1.5	TH000100
W 14 ER16	LT 10	14	16	9.525	1.0	1.2	TH000094
W 19 ER16	LT 10	19	16	9.525	0.8	1.0	TH000134
INTERNAL							
W 11 IR16	LT 10	11	16	9.525	1.1	1.5	TH000103
W 14 IR16	LT 10	14	16	9.525	1.0	1.2	TH000097
W 19 IR16	LT 10	19	16	9.525	0.8	1.0	TH000135

CUTTING DATA



ISO

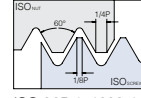
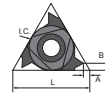
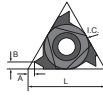

EXTERNAL RIGHT

INTERNAL RIGHT

ISO 965-1: 1999-11
DIN13: 2005-08

DESIGNATION	GRADE	PITCH mm	DIMENSIONS				CATALOG #
			L mm	I.C.	A	B	
EXTERNAL							
ISO 0.5 ER16	LT 10	0.5	16	9.525	0.6	0.4	TH000122
ISO 0.6 ER16	LT 10	0.6	16	9.525	0.6	0.6	TH000123
ISO 0.7 ER16	LT 10	0.7	16	9.525	0.6	0.6	TH000124
ISO 0.75 ER16	LT 10	0.75	16	9.525	0.6	0.6	TH000125
ISO 0.8 ER16	LT 10	0.8	16	9.525	0.6	0.6	TH000036
ISO 1.0 ER16	LT 10	1.0	16	9.525	0.7	0.7	TH000037
ISO 1.25 ER16	LT 10	1.25	16	9.525	0.8	0.9	TH000043
ISO 1.5 ER16	LT 10	1.5	16	9.525	0.8	1.0	TH000049
ISO 1.75 ER16	LT 10	1.75	16	9.525	0.9	1.2	TH000055
ISO 2.0 ER16	LT 10	2.0	16	9.525	1.0	1.3	TH000058
ISO 2.5 ER16	LT 10	2.5	16	9.525	1.1	1.5	TH000064
ISO 3.0 ER16	LT 10	3.0	16	9.525	1.2	1.3	TH000070
ISO 3.5 ER22	LT 10	3.5	22	12.70	1.6	1.5	TH000126
ISO 4.0 ER22	LT 10	4.0	22	12.70	1.6	1.5	TH000127
INTERNAL							
ISO 1.0 IR11	LT 10	1.0	11	6.35	0.7	0.7	TH000028
ISO 1.5 IR11	LT 10	1.5	11	6.35	0.8	1.0	TH000031
ISO 2.0 IR11	LT 10	2.0	11	6.35	0.8	0.9	TH000034
ISO 0.5 IR16	LT 10	0.5	16	9.525	0.6	0.4	TH000128
ISO 0.6 IR16	LT 10	0.6	16	9.525	0.6	0.6	TH000129
ISO 0.7 IR16	LT 10	0.7	16	9.525	0.6	0.6	TH000130
ISO 0.75 IR16	LT 10	0.75	16	9.525	0.6	0.6	TH000131
ISO 0.8 IR16	LT 10	0.8	16	9.525	0.6	0.6	TH000132
ISO 1.0 IR16	LT 10	1.0	16	9.525	0.7	0.7	TH000040
ISO 1.25 IR16	LT 10	1.25	16	9.525	0.8	0.9	TH000046
ISO 1.5 IR16	LT 10	1.5	16	9.525	0.8	1.8	TH000052
ISO 1.75 IR16	LT 10	1.75	16	9.525	0.9	1.2	TH000056
ISO 2.0 IR16	LT 10	2.0	16	9.525	1.0	1.3	TH000061
ISO 2.5 IR16	LT 10	2.5	16	9.525	1.1	1.5	TH000067
ISO 3.0 IR16	LT 10	3.0	16	9.525	1.2	1.5	TH000073
ISO 4.0 IR22	LT 10	4.0	22	12.70	1.6	2.3	TH000133

CUTTING DATA



THREAD TURNING

THREADING TOOL HOLDERS

EXTERNAL RIGHT HANDED TOOL HOLDERS

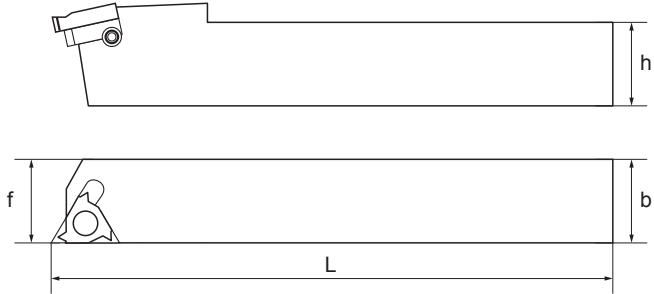

DESIGNATION	TYPE	H	B	F	L	CATALOG #
HER1616H16	ER16	16	16	16	100	TH200001
HER2020K16	ER16	20	20	20	125	TH200004
HER2525M16	ER16	25	25	25	150	TH200007

* Accessories on request

SCREW M2001549

KEY M2000602

INTERNAL RIGHT HANDED TOOL HOLDERS

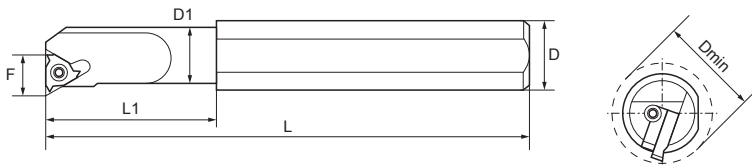

DESIGNATION	TYPE	D	D1	D min	L	L1	F	CATALOG #
HIR0010H11	IR11	10	10	12.5	100	-	7.3	TH200010
HIR0010K11	IR11	16	10	12.5	125	25	7.3	TH200013
HIR0013M16	IR16	16	13	16.5	150	32	10.4	TH200016
HIR0016P16	IR16	20	16	19.5	170	40	11.6	TH200019
HIR0020P16	IR16	20	20	23.5	170	-	13.6	TH200022
HIR0025R16	IR16	25	25	28.5	200	-	16.3	TH200025

* Accessories on request

SCREW M2001549

KEY M2000602

MILLING



FACE MILLING	69
SHOULDER MILLING	91
HIGH FEED MILLING	111
COPY MILLING	121
SLOT MILLING	133

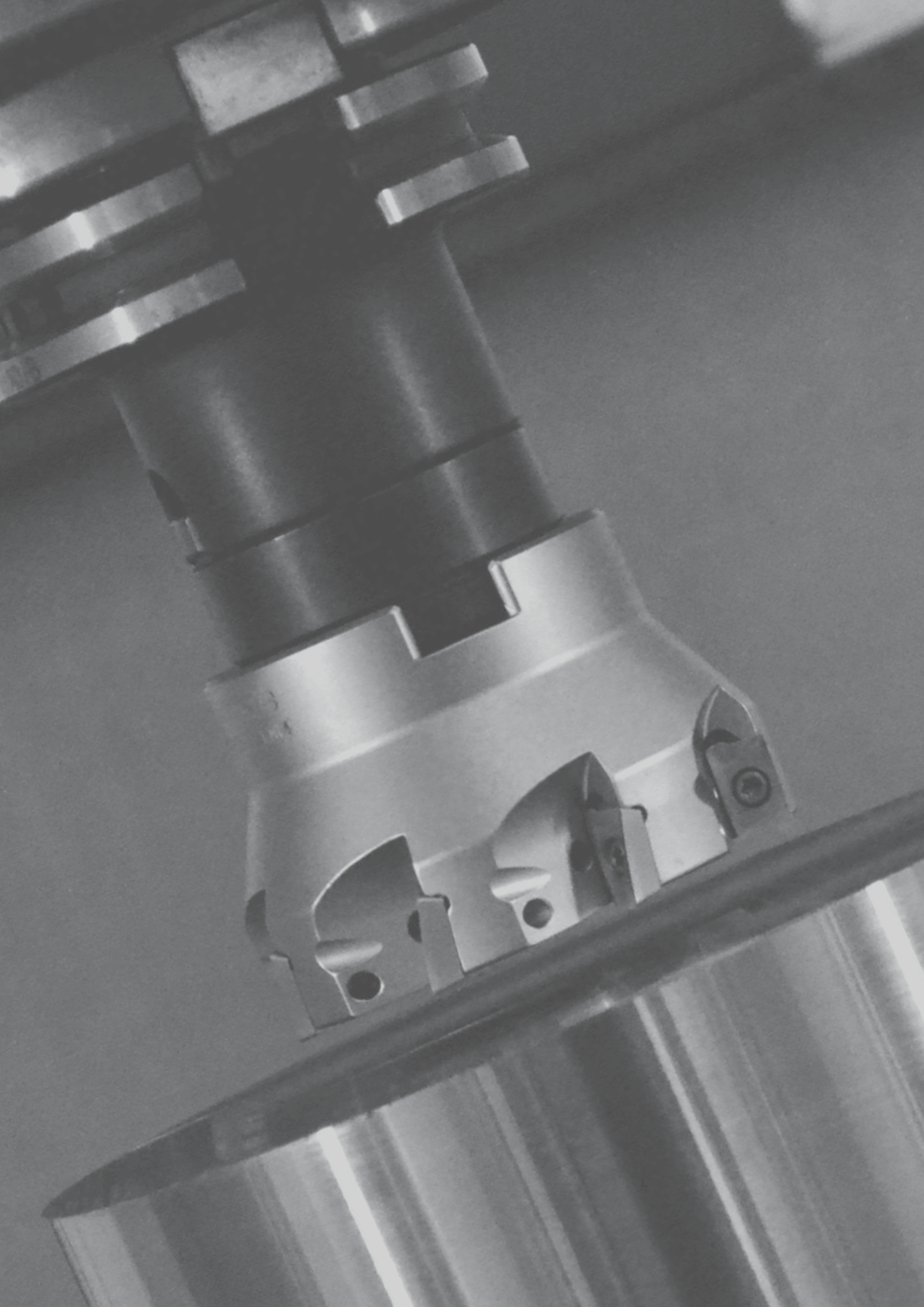

MAGIA MILLING GRADES

High performance grades for top level machining

CHOOSE THE RIGHT PREMIUM MILLING GRADE

LT 3000 - RECOMMENDED FOR GENERAL USE

- Progressive and predictable wear. The silver top layer of our Multi-Mat™ LT 3000 shows higher contrast on worn edges making it easy to identify which edges have been used and the level of wear development.
- More flexibility and extended application range. With a more tolerant coating, LT 3000 permits added flexibility and a wider application range as it can be applied at higher and lower cutting speeds than LT 30.

LT 3130 - RECOMMENDED FOR STEELS & STAINLESS STEELS

- Magia Pro LT 3130 has been specifically designed for remarkable performance in steels and stainless steels
- Low friction coefficient reduces heat generation and provides excellent thermal stability for milling at high speeds
- Higher hardness delivers substantial improvement in tool life and exceptional wear resistance leading to fewer production stops

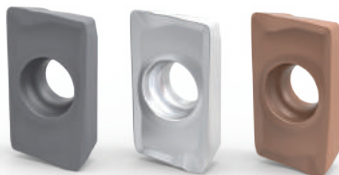

MILLING

INSERT DESIGNATION (BASED ON ISO NORMS)



1. Insert Shape

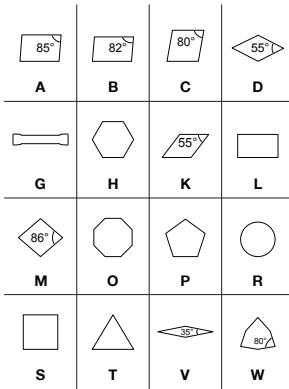

2. Clearance Angle



Letter Symbol	α
A	3°
B	5°
C	7°
D	15°
E	20°
F	25°
G	30°
N	0°
P	11°
O	Special

3. Tolerance Class

	Symbol	D	M	S
d (mm)	A	± 0.025	± 0.005	± 0.025
m (mm)	C	± 0.025	± 0.013	± 0.025
s (mm)	E	± 0.025	± 0.025	± 0.025
	F	± 0.013	± 0.005	± 0.025
	G	± 0.025	± 0.025	± 0.130
	H	± 0.013	± 0.013	± 0.025
	J*	$\pm 0.05-0.15$	± 0.005	± 0.025
	K*	$\pm 0.05-0.15$	± 0.013	± 0.025
	L*	$\pm 0.05-0.15$	± 0.025	± 0.025
	M*	$\pm 0.05-0.15$	$\pm 0.08-0.20$	± 0.130
	N*	$\pm 0.05-0.15$	$\pm 0.08-0.20$	± 0.025
	U*	$\pm 0.08-0.25$	$\pm 0.13-0.38$	± 0.130

* Depending on the insert size.

4. Fixing and Chipbreaker Types

Type	Symbol	Type	Symbol
A		N	
B		P	
F		R	
G		T	
H		W	
M		X	Special Design

16

04

PD

T

R

5

6

7

8

9

10

5. Cutting Edge Length

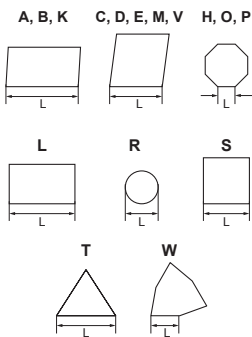

Disregarding any decimals e.g. 12,7 = 12

6. Insert Thickness

Symbol	mm
01	= 1.59
T1	= 1.98
02	= 2.38
03	= 3.18
T3	= 3.97
04	= 4.76
05	= 5.56
06	= 6.35
07	= 7.94
09	= 9.52

7. Insert Corner Radius

1st letter (Milling)

- A = 45°
- D = 60°
- E = 75°
- F = 85°
- P = 90°
- Z = other

00 = Sharp corner or round insert (inch version)

M0 = Round insert (metric version)

01 = 0.1 mm

02 = 0.2 mm

04 = 0.4 mm

08 = 0.8 mm

12 = 1.2 mm

16 = 1.6 mm

etc

2nd letter (Milling)

- A = 3°
- B = 5°
- C = 7°
- D = 15°
- E = 20°
- F = 25°
- G = 30°
- N = 0°
- P = 11°
- Z = other

8. Edge Preparation

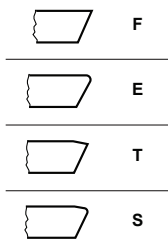

Optional information

9. Cutting Direction

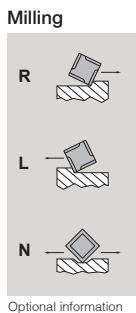

10. Internal Designation

e.g. Application (Milling)

- 45 = 45° Approach Angle
- 90 = 90° Approach Angle
- HF = High Feed

Optional information

MILLING

LAMINA TECHNOLOGIES CUTTER DESIGNATION

LT 741 C - W - D016 / 2

1	2	3	4	5	6
1. Standard	2. Lamina Cutter Family Number	3. Coupling	4. Internal Coolant	5. Diameter	6. # of Teeth
LT - Metric RILT - Imperial		C - Cylindrical CL - Cylindrical Long W - Weldon WL - Weldon Long M - Shell Mill S - Screw Coupling FW - Long Edge	D - No Internal Coolant W - Internal Coolant	D016 = 16 mm D1000 = 1"	2 = 2 teeth

LAMINA MILLING CUTTER LINES

CUTTER LINE	FITS INSERT
LT 060	RD.. 0602 M0
LT 070	RD.. 0702 M0
LT 080	RD.. 0803 M0
LT 100	RD.. 10T3 M0
LT 101	RX.. 10T3 M0
LT 120	RD.. 1204 M0
LT 121	RX.. 1204 M0
LT 160	RD.. 1604 M0
LT 310	TP.. 1603
LT 320	TP.. 2204 PDTR
LT 400	SPMT 060304 TN SPMT 09T308 FN/TN SPMT 120408 TN
LT 550	SEK. 1203 AFTN
LT 600	SEKT 1204 AFTN
LT 610	SEKT 12T3 AGSN
LT 645	HNKX 0604-45
LT 670	SDKT 1204 AETN
LT 720	AOMT 123608 PETR
LT 731	APKT 160408 PDTR

CUTTER LINE	FITS INSERT
LT 737	APKT 1705 PETR
LT 741	APKT 100308 PDTR
LT 745	APKT 100332/40 PDTR
LT 750	SP.. 1203
LT 752	APKT 060204 PDTR APKT 0602-HF APKW 0602-HF
LT 755	APMT 1135 PDTR
LT 760	APMT 1604 ...
LT 770	LDMT 1504 PDSR
LT 790	ADKT 1505 PDTR
LT 800	OFMT 05T305 TN
LT 805	OFMT 050405 TR
LT 820	ODM. 060508 TN
LT 880	OFER 070405 TN
LT 902	SDKX 0904-HF
LT 903	SDKX 1205-HF
LT 946	SNKX 1205-45
LT 947	SNKX 1607-45
LT 987	ONKX 0806-45

FACE MILLING



FACE MILLING

FEATURED GEOMETRIES

SNKX -45

- Square positive insert with 8 cutting edges
- Full Multi-Mat™ flexibility in a thick and strong insert
- Positive edges provide soft and stable cut

ONKX

- Double-sided octagonal milling insert for face milling
- Economical solution with 16 cutting edges!
- Roughing and Semi-Finishing
- Mostly recommended for use on steel and cast Iron - up to 4.5mm d.o.c.

HNKX

- New geometry available Q3 2017
- Magia LT 3000 and Magia Pro LT 3130 for steels and stainless steels
- Multi-Mat™ insert with 12 cutting edges

SEKT

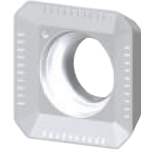

MAGIA PRO

DESIGNATION	GRADE	RADIUS (mm)	CUTTING EDGES	CUTTER LINE	MATERIAL RECOMMENDATION	CATALOG #
SEKT 1204 AFTN	LT 3130	-	4	LT 600		M0004486
SEKT 12T3 AGSN	LT 3130	-	4	LT 610		M0004487

MAGIA

DESIGNATION	GRADE	RADIUS (mm)	CUTTING EDGES	CUTTER LINE	MATERIAL RECOMMENDATION	CATALOG #
SEKT 1204 AFTN	LT 3000	-	4	LT 600		M0002230
SEKT 12T3 AGSN	LT 3000	-	4	LT 610		M0002231

ALPHA

DESIGNATION	GRADE	RADIUS (mm)	CUTTING EDGES	CUTTER LINE	MATERIAL RECOMMENDATION	CATALOG #
SEKT 1204 AFTN	LT 30	-	4	LT 600		M0000045
SEKT 12T3 AGSN	LT 30	-	4	LT 610		M0000455

MATERIAL GROUP

STEEL	HIGH TEMP ALLOYS
STAINLESS STEEL	HARDENED MATERIAL
CAST IRON	ALU(>8%Si)

CUTTING SPEED



DOC / FEED



ORDERING EXAMPLE

QUANTITY	10 PIECES
DESIGNATION + GRADE	CCMT 060204 N11 LT 1000
CATALOG NUMBER	T0001888

CUTTERS SEKT

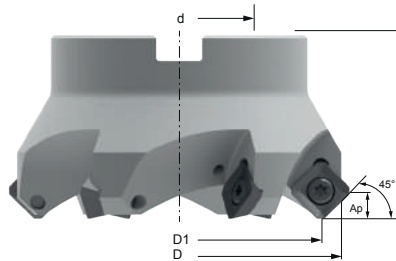

SHELL MILL - SEKT 1204

DESIGNATION	D	D1	d	L	A_p	Z	α	CATALOG #
LT 600 M-W-D040/3	53	40	16	40	6	3	10	M2000546
LT 600 M-W-D050/4	63	50	22	48	6	4	8	M2000547
LT 600 M-W-D063/5	76	63	22	48	6	5	6	M2000548
LT 600 M-W-D080/6	93	80	27	50	6	6	4.5	M2000549
LT 600 M-W-D100/6	113	100	32	50	6	6	3.5	M2000550
LT 600 M-W-D125/7	138	125	40	63	6	7	3	M2000551
LT 600 M-D-D160/8	173	160	40	63	6	8	2.2	M2000552

SCREW M2000599
KEY M2000603

SHELL MILL - SEKT 12T3

DESIGNATION	D	D1	d	L	A_p	Z	α	CATALOG #
LT 610 M-W-D040/3	53	40	16	40	6	3	10	M2001431
LT 610 M-W-D050/4	63	50	22	48	6	4	8	M2001382
LT 610 M-W-D063/5	76	63	22	48	6	5	6	M2001383
LT 610 M-W-D080/6	93	80	27	50	6	6	4.5	M2001384
LT 610 M-W-D100/6	113	100	32	50	6	6	3.5	M2001432
LT 610 M-W-D125/7	138	125	40	63	6	7	3	M2001433
LT 610 M-D-D160/8	173	160	40	63	6	8	2.2	M2001434

SCREW M2001418
KEY M2000602

SNKX-45

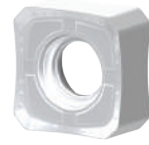

MAGIA PRO

DESIGNATION	GRADE	RADIUS (mm)	CUTTING EDGES	CUTTER LINE	MATERIAL RECOMMENDATION	CATALOG #
SNKX 1205-45	LT 3130	-	8	LT 946		M0004490
SNKX 1607-45	LT 3130	-	8	LT 947		M0004491

MAGIA

DESIGNATION	GRADE	RADIUS (mm)	CUTTING EDGES	CUTTER LINE	MATERIAL RECOMMENDATION	CATALOG #
SNKX 1205-45	LT 3000	-	8	LT 946		M0003415
SNKX 1607-45	LT 3000	-	8	LT 947		M0002237

ALPHA

DESIGNATION	GRADE	RADIUS (mm)	CUTTING EDGES	CUTTER LINE	MATERIAL RECOMMENDATION	CATALOG #
SNKX 1205-45	LT 30	-	8	LT 946		M0003221
SNKX 1607-45	LT 30	-	8	LT 947		M0002205

MATERIAL GROUP

	STEEL		HIGH TEMP ALLOYS
	STAINLESS STEEL		HARDENED MATERIAL
	CAST IRON		ALU(>8%Si)

CUTTING SPEED



DOC / FEED



ORDERING EXAMPLE

QUANTITY	10 PIECES
DESIGNATION + GRADE	CCMT 060204 NN LT 1000
CATALOG NUMBER	T0001888

CUTTERS SNKX - 45

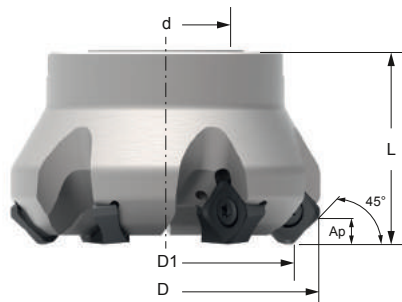

SHELL MILL - SNKX 1205-45

DESIGNATION	D	D1	d	L	A_p	Z	CATALOG #
LT 946 M-W-D050/4	64	50	22	48	6	4	M2003223
LT 946 M-W-D063/6	77	63	22	48	6	6	M2003224
LT 946 M-W-D080/7	94	80	27	50	6	7	M2003225
LT 946 M-W-D100/8	114	100	32	50	6	8	M2003226
LT 946 M-W-D125/10	139	125	40	63	6	10	M2003227
LT 946 M-D-D160/12*	174	160	40	63	6	12	M2003228

*On Request

SCREW M2003295
KEY M2003296

SHELL MILL - SNKX 1607-45

DESIGNATION	D	D1	d	L	A_p	Z	CATALOG #
LT 947 M-W-D050/4	69	50	22	50	7	4	M2002200
LT 947 M-W-D063/5	82	63	22	50	7	5	M2002201
LT 947 M-W-D080/6	99	80	27	50	7	6	M2002202
LT 947 M-W-D100/7	119	100	32	63	7	7	M2002203
LT 947 M-W-D125/8	144	125	40	63	7	8	M2002204
LT 947 M-D-D160/10	179	160	40	63	7	10	M2003670
LT 947 M-D-D200/12*	219	200	60	63	7	12	M2003671
LT 947 M-D-D250/14*	269	250	60	63	7	14	M2003672

*On Request

SCREW M2003295
KEY M2003296

HNKX-45

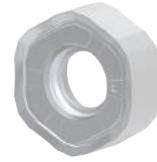

MAGIA PRO

DESIGNATION	GRADE	RADIUS (mm)	CUTTING EDGES	CUTTER LINE	MATERIAL RECOMMENDATION	CATALOG #
HNKX 0604-45*	LT 3130	-	12	LT 645		M0004473

MAGIA

DESIGNATION	GRADE	RADIUS (mm)	CUTTING EDGES	CUTTER LINE	MATERIAL RECOMMENDATION	CATALOG #
HNKX 0604-45*	LT 3000	-	12	LT 645		M0004364

CUTTERS HNKX

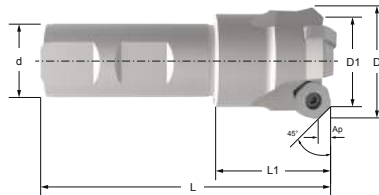

END MILL - HNKX 0604-45

DESIGNATION	D	D1	d	L	L1	Ap	Z	CATALOG #
LT 645 W-W-D025/3	34	25	20	32	82	3.5	3	M2001440
LT 645 W-W-D032/4	41	32	25	40	97	3.5	4	M2001441
LT 645 W-W-D040/5	49	40	32	40	115	3.5	5	M2001442

SCREW KEY M2000597
M2000602

* HNKX-45 and cutter family LT 645 Available Q3 2017

MATERIAL GROUP	
STEEL	HIGH TEMP ALLOYS
STAINLESS STEEL	HARDENED MATERIAL
CAST IRON	ALU(>8%Si)

CUTTING SPEED



DOC / FEED



ORDERING EXAMPLE

QUANTITY	10 PIECES
DESIGNATION + GRADE	CCMT 060204 NN LT 1000
CATALOG NUMBER	T0001888

CUTTERS HNKX

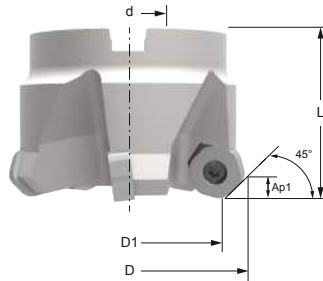

SHELL MILL - HNKX 0604-45

DESIGNATION	D	D1	d	L1	Ap	Z	CATALOG #
LT 645 M-W-D050/5	50	59	22	40	3.5	5	M2001435
LT 645 M-W-D063/6	63	72	22	40	3.5	6	M2001436
LT 645 M-W-D080/8	80	89	27	50	3.5	8	M2001437
LT 645 M-W-D100/9	100	109	32	50	3.5	9	M2001438
LT 645 M-W-D125/12	125	134	40	63	3.5	12	M2001439

SCREW KEY M2000597
M2000602

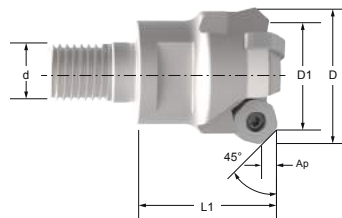

SCREW COUPLING - HNKX 0604-45

DESIGNATION	D	D1	d	L	Ap	Z	CATALOG #
LT 645 S-W-D025/3	34	25	M16	32	3.5	3	M2001443
LT 645 S-W-D032/4	41	32	M16	40	3.5	4	M2001444
LT 645 S-W-D040/5	49	40	M16	40	3.5	5	M2001445

SCREW KEY M2000597
M2000602

* HNKX-45 and cutter family LT 645 Available Q3 2017

ONKX

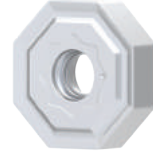
**MAGIA PRO**

DESIGNATION	GRADE	RADIUS (mm)	CUTTING EDGES	CUTTER LINE	MATERIAL RECOMMENDATION	CATALOG #
ONKX 0806-45	LT 3130	0.8	16	LT 987		M0004475

MAGIA

DESIGNATION	GRADE	RADIUS (mm)	CUTTING EDGES	CUTTER LINE	MATERIAL RECOMMENDATION	CATALOG #
ONKX 0806-45	LT 3000	0.8	16	LT 987		M0002211

ALPHA

DESIGNATION	GRADE	RADIUS (mm)	CUTTING EDGES	CUTTER LINE	MATERIAL RECOMMENDATION	CATALOG #
ONKX 0806-45	LT 30	0.8	16	LT 987		M0003673

MATERIAL GROUP

STEEL	HIGH TEMP ALLOYS
STAINLESS STEEL	HARDENED MATERIAL
CAST IRON	ALU(>8%Si)

CUTTING SPEED



DOC / FEED



ORDERING EXAMPLE

QUANTITY	10 PIECES
DESIGNATION + GRADE	CCMT 060204 NN LT 1000
CATALOG NUMBER	T0001888

CUTTERS ONKX

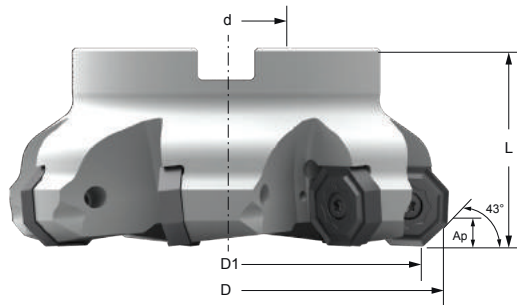

SHELL MILL - ONKX 0806

DESIGNATION	D	D1	d	L	Ap	Z	CATALOG #
LT 987 M-W-D063/5	75.7	63	22	50	5	5	M2003631
LT 987 M-W-D080/6	92.7	80	27	50	5	6	M2003632
LT 987 M-W-D100/7	112.7	100	32	50	5	7	M2003633
LT 987 M-W-D125/8	137.7	125	40	63	5	8	M2003634
LT 987 M-D-D160/10 ¹	172.7	160	40	63	5	10	M2003635
LT 987 M-D-D200/12* ¹	212.7	200	60	63	5	12	M2003636
LT 987 M-D-D250/14* ¹	262.7	250	60	63	5	14	M2003637

*On Request

SCREW M2000599
KEY M2000603¹ Accessories for coolant available

CUTTER	ACCESSORY
M2003635	M2004024
M2003636	M2001847
M2003637	M2001847

SDKT

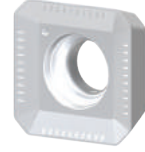

MAGIA

DESIGNATION	GRADE	RADIUS (mm)	CUTTING EDGES	CUTTER LINE	MATERIAL RECOMMENDATION	CATALOG #
SDKT 1204 AETN	LT 3000	-	4	LT 670		M0003411

ALPHA

DESIGNATION	GRADE	RADIUS (mm)	CUTTING EDGES	CUTTER LINE	MATERIAL RECOMMENDATION	CATALOG #
SDKT 1204 AETN	LT 30	-	4	LT 670		M0000171

CUTTERS SDKT

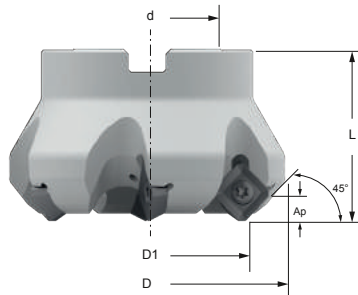

SHELL MILL - SDKT 1204 AETN

DESIGNATION	D	D1	d	L	Ap	Z	α	CATALOG #
LT 670 M-W-D050/4*	63	50	22	48	6	4	8	M2000553
LT 670 M-W-D063/5*	76	63	22	48	6	5	6	M2000555
LT 670 M-W-D080/6*	93	80	27	50	6	6	4.5	M2000556
LT 670 M-W-D100/6*	113	100	32	50	6	6	3.5	M2000557
LT 670 M-W-D125/7*	138	125	40	63	6	7	3	M2000558

*On Request

SCREW M2000598
KEY M2000603

MATERIAL GROUP

- STEEL
- STAINLESS STEEL
- CAST IRON
- HIGH TEMP ALLOYS
- HARDENED MATERIAL
- ALU(>8%Si)

CUTTING SPEED



DOC / FEED



ORDERING EXAMPLE

QUANTITY 10 PIECES
DESIGNATION + GRADE CCMT 060204 NN LT 1000
CATALOG NUMBER T0001888

SPUN



MAGIA

DESIGNATION	GRADE	RADIUS (mm)	CUTTING EDGES	CUTTER LINE	MATERIAL RECOMMENDATION	CATALOG #
SPUN 120308	LT 3000	0.80	4	LT 750		M0004039

ALPHA

DESIGNATION	GRADE	RADIUS (mm)	CUTTING EDGES	CUTTER LINE	MATERIAL RECOMMENDATION	CATALOG #
SPUN 120308	LT 30	0.80	4	LT 750		M0000050

CUTTERS SPUN

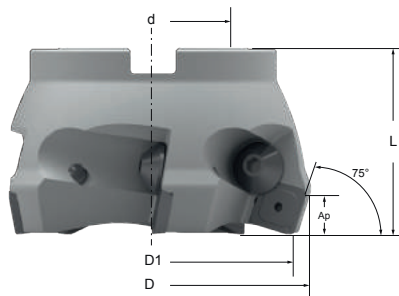

SHELL MILL - SPUN 120308

DESIGNATION	D	D1	d	L	Ap	Z	CATALOG #
LT 750 M-D-D063/4*	69	63	22	40	9	4	M2000571
LT 750 M-D-D080/5*	86	80	27	50	9	5	M2000572
LT 750 M-D-D100/7*	106	100	32	50	9	7	M2000574
LT 750 M-D-D125/8*	131	125	40	63	9	8	M2000575
LT 750 M-D-D160/10*	166	160	40	63	9	10	M2000576
LT 750 M-D-D200/12*	206	200	60	63	9	12	M2000577
LT 750 M-D-D250/14*	256	250	60	63	9	14	M2000578

*On Request

SCREW KEY M2000606
M2000609

MATERIAL GROUP



CUTTING SPEED



DOC / FEED



ORDERING EXAMPLE

QUANTITY	10 PIECES
DESIGNATION + GRADE	CCMT 060204 NN LT 1000
CATALOG NUMBER	T0001888

SEKN



MAGIA

DESIGNATION	GRADE	RADIUS (mm)	CUTTING EDGES	CUTTER LINE	MATERIAL RECOMMENDATION	CATALOG #
SEKN 1203 AFTN	LT 3000	-	4	LT 550		M0004031
SEKN 1204 AFTN	LT 3000	-	4	-		M0004032
SEKN 1504 AFTN	LT 3000	-	4	-		M0004033

ALPHA

DESIGNATION	GRADE	RADIUS (mm)	CUTTING EDGES	CUTTER LINE	MATERIAL RECOMMENDATION	CATALOG #
SEKN 1203 AFTN	LT 30	-	4	LT 550		M0000041
SEKN 1204 AFTN	LT 30	-	4	-		M0000042
SEKN 1504 AFTN	LT 30	-	4	-		M0000045

SEKR



MAGIA

DESIGNATION	GRADE	RADIUS (mm)	CUTTING EDGES	CUTTER LINE	MATERIAL RECOMMENDATION	CATALOG #
SEKR 1203 AFTN	LT 3000	-	4	LT 550		M0004034
SEKR 1204 AFTN	LT 3000	-	4	-		M0004035

ALPHA

DESIGNATION	GRADE	RADIUS (mm)	CUTTING EDGES	CUTTER LINE	MATERIAL RECOMMENDATION	CATALOG #
SEKR 1203 AFTN	LT 30	-	4	LT 550		M0000043
SEKR 1204 AFTN	LT 30	-	4	-		M0000044

MATERIAL GROUP

STEEL	HIGH TEMP ALLOYS
STAINLESS STEEL	HARDENED MATERIAL
CAST IRON	ALU(>8%Si)

CUTTING SPEED



DOC / FEED



ORDERING EXAMPLE

QUANTITY	10 PIECES
DESIGNATION + GRADE	CCMT 060204 NN LT 1000
CATALOG NUMBER	T0001888

CUTTERS SEKN / SEKR

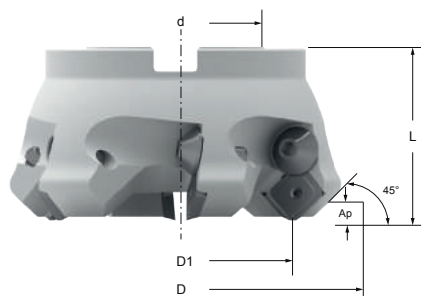

SHELL MILL - SEKN 1203 AFTN / SEKR 1203 AFTN

DESIGNATION	D	D1	d	L	Ap	Z	CATALOG #
LT 550 M-D-D050/4*	63	50	22	48	6	4	M2000563
LT 550 M-D-D063/5*	76	63	22	48	6	5	M2000564
LT 550 M-D-D080/6*	93	80	27	50	6	6	M2000565
LT 550 M-D-D100/6*	113	100	32	50	6	6	M2000566
LT 550 M-D-D125/7*	138	125	40	63	6	7	M2000567
LT 550 M-D-D160/7*	173	160	40	63	6	7	M2000568
LT 550 M-D-D200/10*	213	200	60	63	6	10	M2000569
LT 550 M-D-D250/13*	263	250	60	63	6	13	M2000570

*On Request

SCREW M2000608
KEY M2000609

S P K N



MAGIA

DESIGNATION	GRADE	RADIUS (mm)	CUTTING EDGES	CUTTER LINE	MATERIAL RECOMMENDATION	CATALOG #
SPKN 1203 EDTR	LT 3000	-	4	LT 750		M0004036
SPKN 1204 EDTR	LT 3000	-	4	-		M0004181
SPKN 1504 EDTR	LT 3000	-	4	-		M0004037

ALPHA

DESIGNATION	GRADE	RADIUS (mm)	CUTTING EDGES	CUTTER LINE	MATERIAL RECOMMENDATION	CATALOG #
SPKN 1203 EDTR	LT 30	-	4	LT 750		M0000046
SPKN 1204 EDTR	LT 30	-	4	-		M0000047
SPKN 1504 EDTR	LT 30	-	4	-		M0001673

S P K R



MAGIA

DESIGNATION	GRADE	RADIUS (mm)	CUTTING EDGES	CUTTER LINE	MATERIAL RECOMMENDATION	CATALOG #
SPKR 1203 EDTR	LT 3000	-	4	LT 750		M0004038
SPKR 1204 EDTR	LT 3000	-	4	-		M0004182

ALPHA

DESIGNATION	GRADE	RADIUS (mm)	CUTTING EDGES	CUTTER LINE	MATERIAL RECOMMENDATION	CATALOG #
SPKR 1203 EDTR	LT 30	-	4	LT 750		M0000048
SPKR 1204 EDTR	LT 30	-	4	-		M0000049

MATERIAL GROUP	
STEEL	HIGH TEMP ALLOYS
STAINLESS STEEL	HARDENED MATERIAL
CAST IRON	ALU(>8%Si)

CUTTING SPEED



p. 226

DOC / FEED



see index p. 335

ORDERING EXAMPLE

QUANTITY	10 PIECES
DESIGNATION + GRADE	CCMT 060204 NN LT 1000
CATALOG NUMBER	T0001888

CUTTERS SPKN / SPKR

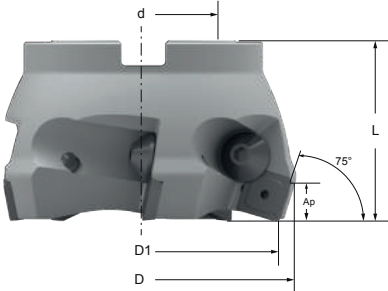

SHELL MILL - SPKN 1203 EDTR / SPKR 1203 EDTR

DESIGNATION	D	D1	d	L	Ap	Z	CATALOG #
LT 750 M-D-D063/4*	69	63	22	40	9	4	M2000571
LT 750 M-D-D080/5*	86	80	27	50	9	5	M2000572
LT 750 M-D-D100/7*	106	100	32	50	9	7	M2000574
LT 750 M-D-D125/8*	131	125	40	63	9	8	M2000575
LT 750 M-D-D160/10*	166	160	40	63	9	10	M2000576
LT 750 M-D-D200/12*	206	200	60	63	9	12	M2000577
LT 750 M-D-D250/14*	256	250	60	63	9	14	M2000578

*On Request

SCREW M2000606
KEY M2000609

ODMT

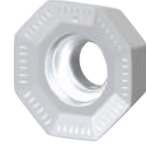

MAGIA

DESIGNATION	GRADE	RADIUS (mm)	CUTTING EDGES	CUTTER LINE	MATERIAL RECOMMENDATION	CATALOG #
ODMT 0504 ZZTR	LT 3000	0.80	8	-		M0003399
ODMT 060508 TN	LT 3000	0.80	8	LT 820		M0002219

ALPHA

DESIGNATION	GRADE	RADIUS (mm)	CUTTING EDGES	CUTTER LINE	MATERIAL RECOMMENDATION	CATALOG #
ODMT 0504 ZZTR	LT 30	0.80	8	-		M0000664
ODMT 060508 TN	LT 30	0.80	8	LT 820		M0001104

ODMW

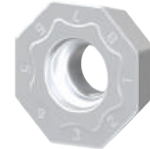

MAGIA

DESIGNATION	GRADE	RADIUS (mm)	CUTTING EDGES	CUTTER LINE	MATERIAL RECOMMENDATION	CATALOG #
ODMW 060508 TN	LT 3000	0.80	8	LT 820		M0003400

ALPHA

DESIGNATION	GRADE	RADIUS (mm)	CUTTING EDGES	CUTTER LINE	MATERIAL RECOMMENDATION	CATALOG #
ODMW 060508 TN	LT 30	0.80	8	LT 820		M0000451

MATERIAL GROUP

STEEL	HIGH TEMP ALLOYS
STAINLESS STEEL	HARDENED MATERIAL
CAST IRON	ALU(>8%Si)

CUTTING SPEED



DOC / FEED



ORDERING EXAMPLE

QUANTITY	10 PIECES
DESIGNATION + GRADE	CCMT 060204 NN LT 1000
CATALOG NUMBER	T0001888

CUTTERS ODMT / ODMW

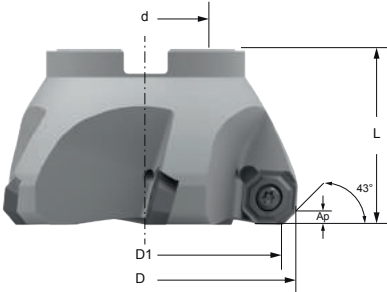

SHELL MILL - ODMT 060508 TN / ODMW 060508 TN

DESIGNATION	D	D1	d	L	Ap	Z	CATALOG #
LT 820 M-D-D063/5*	73	63	22	50	3.5	5	M2003837
LT 820 M-D-D080/5*	90	80	27	50	3.5	5	M2000711
LT 820 M-D-D100/6*	110	100	32	50	3.5	6	M2000712

*On Request

SCREW M2002733
KEY M2000603

O F M T



MAGIA

DESIGNATION	GRADE	RADIUS (mm)	CUTTING EDGES	CUTTER LINE	MATERIAL RECOMMENDATION	CATALOG #
OFMT 050405 TR	LT 3000	0.8	8	LT 805		M0002220
OFMT 05T305 TN	LT 3000	0.5	8	LT 800		M0002221
OFMT 070405 TN	LT 3000	0.5	8	-		M0002222

ALPHA

DESIGNATION	GRADE	RADIUS (mm)	CUTTING EDGES	CUTTER LINE	MATERIAL RECOMMENDATION	CATALOG #
OFMT 050405 TR	LT 30	0.8	8	LT 805		M0000034
OFMT 05T305 TN	LT 30	0.5	8	LT 800		M0000591
OFMT 070405 TN	LT 30	0.5	8	-		M0000592

MATERIAL GROUP

STEEL	HIGH TEMP ALLOYS
STAINLESS STEEL	HARDENED MATERIAL
CAST IRON	ALU(>8%Si)

CUTTING SPEED



DOC / FEED



ORDERING EXAMPLE

QUANTITY	10 PIECES
DESIGNATION + GRADE	CCMT 060204 NN LT 1000
CATALOG NUMBER	T0001888

CUTTERS OFMT

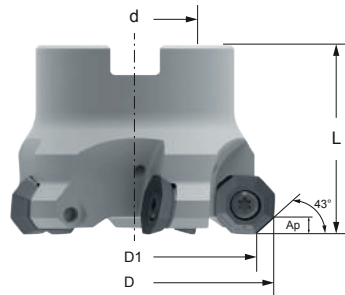

SHELL MILL - OFMT 050405 TR

DESIGNATION	D	D1	d	L	Ap	Z	CATALOG #
LT 805 M-W-D050/4*	57	50	22	40	3.5	4	M2001604
LT 805 M-W-D063/5*	70	63	22	40	3.5	5	M2001605

*On Request

SCREW M2000597
KEY M2000602

SHELL MILL - OFMT 05T305 TN

DESIGNATION	D	D1	d	L	Ap	Z	CATALOG #
LT 800 M-W-D040/3	47	40	16	40	3	3	M2000502
LT 800 M-W-D050/4	57	50	22	40	3	4	M2000503
LT 800 M-W-D063/5	70	63	22	40	3	5	M2000504
LT 800 M-W-D080/6	87	80	27	50	3	6	M2000505
LT 800 M-W-D100/7	107	100	32	50	3	7	M2000506
LT 800 M-W-D125/8	132	125	40	63	3	8	M2000507

SCREW M2000597
KEY M2000602

O F E R



MAGIA

DESIGNATION	GRADE	RADIUS (mm)	CUTTING EDGES	CUTTER LINE	MATERIAL RECOMMENDATION	CATALOG #
OFER 070405 TN	LT 3000	0.80	8	LT 880		M0003401

ALPHA

DESIGNATION	GRADE	RADIUS (mm)	CUTTING EDGES	CUTTER LINE	MATERIAL RECOMMENDATION	CATALOG #
OFER 070405 TN	LT 30	0.80	8	LT 880		M0000033

CUTTERS OFER

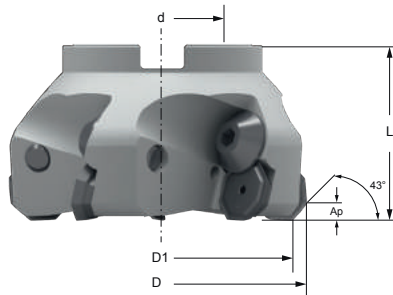

SHELL MILL - OFER 070405

DESIGNATION	D	D1	d	L	Ap	Z	CATALOG #
LT 880 M-W-D063/4*	73	63	22	40	5	4	M2000508
LT 880 M-W-D080/5*	90	80	27	50	5	5	M2000510
LT 880 M-W-D100/6*	110	100	32	50	5	6	M2000511
LT 880 M-W-D125/8*	135	125	40	63	5	8	M2000512
LT 880 M-D-D160/10*	170	160	40	63	5	10	M2000513

*On Request

SCREW KEY M2000606
M2000609

MATERIAL GROUP

STEEL	HIGH TEMP ALLOYS
STAINLESS STEEL	HARDENED MATERIAL
CAST IRON	ALU(>8%Si)

CUTTING SPEED



DOC / FEED



ORDERING EXAMPLE

QUANTITY	10 PIECES
DESIGNATION + GRADE	CCMT 060204 NN LT 1000
CATALOG NUMBER	T0001888

SHOULDER MILLING

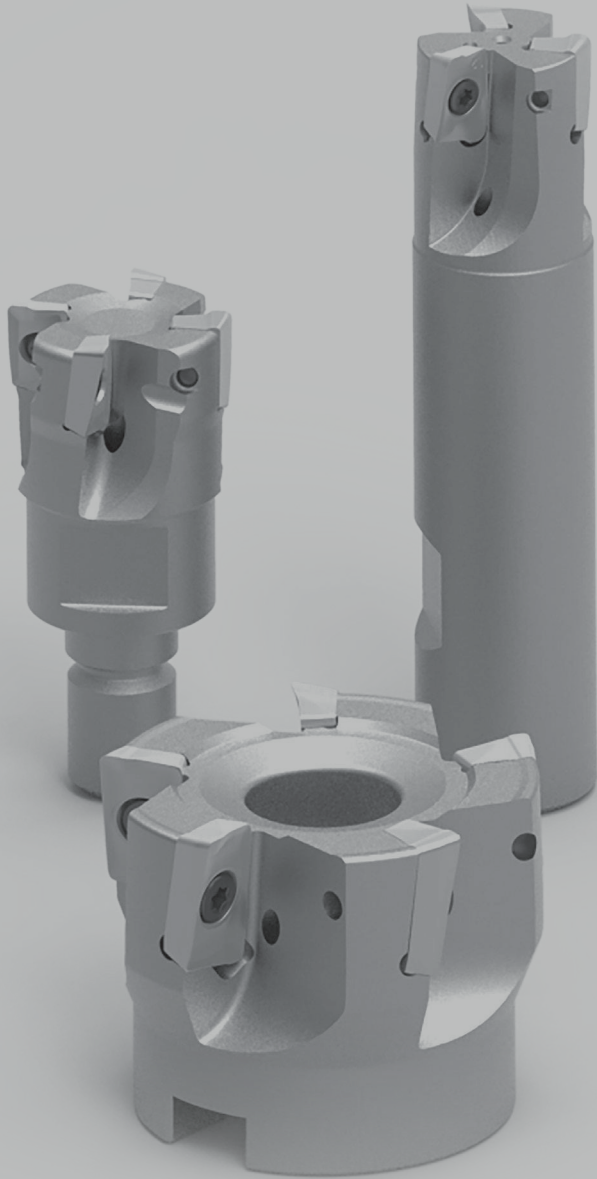

90° SHOULDER MILLING

MAXIMUM VERSATILITY

90° inserts can be used in a wide range of applications including

- Shoulder milling
- Plunging
- Pocket milling
- Surfacing
- Ramping down
- Helical interpolation

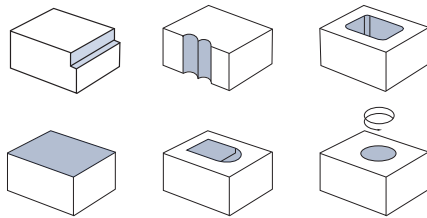

FEATURED GEOMETRY

APKT

- Multi-Mat™ geometry for maximum versatility
- Accurate 90° wall finishing
- Excellent ramping down ability

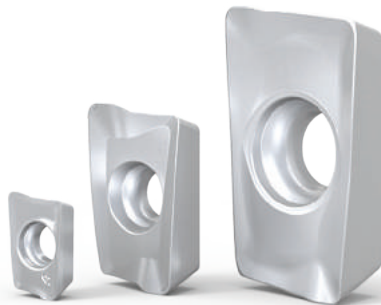

APKT



MAGIA PRO

DESIGNATION	GRADE	RADIUS (mm)	CUTTING EDGES	CUTTER LINE	MATERIAL RECOMMENDATION	CATALOG #
APKT 060204 PDTR	LT 3130	0.40	2	LT 752		M0004468
APKT 100308 PDTR†	LT 3130	0.80	2	LT 741		M0004470
APKT 160408 PDTR†	LT 3130	0.80	2	LT 731		M0004471

MAGIA

DESIGNATION	GRADE	RADIUS (mm)	CUTTING EDGES	CUTTER LINE	MATERIAL RECOMMENDATION	CATALOG #
APKT 060204 PDTR	LT 3000	0.40	2	LT 752		M0004026
APKT 100304 PDTR	LT 3000	0.40	2	LT 741		M0003389
APKT 100308 PDTR†	LT 3000	0.80	2	LT 741		M0003388
APKT 100312 PDTR	LT 3000	1.20	2	LT 741		M0003391
APKT 100316 PDTR	LT 3000	1.60	2	LT 741		M0003392
APKT 100332 PDTR	LT 3000	3.20	2	LT 745		M0003394
APKT 100340 PDTR	LT 3000	4.00	2	LT 745		M0003395
APKT 160408 PDTR†	LT 3000	0.80	2	LT 731		M0002182
APKT 160416 PDTR	LT 3000	1.60	2	LT 731		M0004027
APKT 160424 PDTR†	LT 3000	2.40	2	LT 731		M0004029
APKT 160432 PDTR	LT 3000	3.20	2	LT 737		M0004030
APKT 1705 PETR	LT 3000	0.80	2	LT 737		M0002212

† Please note from 1 September 2017 the following changes in designation will take effect.
Catalog numbers will remain the same.

OLD DESIGNATION	NEW DESIGNATION
APKT 1003 PDTR (NEW)	APKT 100308 PDTR
APKT 1604 PDTR (NEW)	APKT 160408 PDTR
APKT 160424 PDTR (NEW)	APKT 160424 PDTR

MATERIAL GROUP	
STEEL	HIGH TEMP ALLOYS
STAINLESS STEEL	HARDENED MATERIAL
CAST IRON	ALU(>8%Si)

CUTTING SPEED
p. 226

DOC / FEED
see index p. 335

ORDERING EXAMPLE	
QUANTITY	10 PIECES
DESIGNATION + GRADE	CCMT 060204 NN LT 1000
CATALOG NUMBER	T0001888

ALPHA

DESIGNATION	GRADE	RADIUS (mm)	CUTTING EDGES	CUTTER LINE	MATERIAL RECOMMENDATION	CATALOG #
APKT 100304 PDTR	LT 30	0.40	2	LT 741		M0002920
APKT 100308 PDTR†	LT 30	0.80	2	LT 741		M0002918
APKT 100312 PDTR	LT 30	1.20	2	LT 741		M0002921
APKT 100316 PDTR	LT 30	1.60	2	LT 741		M0003094
APKT 100332 PDTR	LT 30	3.20	2	LT 745		M0002922
APKT 100340 PDTR	LT 30	4.00	2	LT 745		M0002923
APKT 1604 PDTR	LT 30	0.95	2	-		M0000021
APKT 160408 PDTR†	LT 30	0.80	2	LT 731		M0000022
APKT 160416 PDTR	LT 30	1.60	2	LT 731		M0000172
APKT 160424 PDTR†	LT 30	2.40	2	LT 731		M0003833
APKT 160432 PDTR	LT 30	3.20	2	LT 737		M0001569
APKT 1705 PETR	LT 30	0.80	2	LT 737		M0001810

MATERIAL GROUP

	STEEL		HIGH TEMP ALLOYS
	STAINLESS STEEL		HARDENED MATERIAL
	CAST IRON		ALU(>8%Si)

CUTTING SPEED



p. 226

DOC / FEED



see index p. 335

ORDERING EXAMPLE

QUANTITY	10 PIECES
DESIGNATION + GRADE	CCMT 060204 NN LT 1000
CATALOG NUMBER	T0001888

CUTTERS APKT

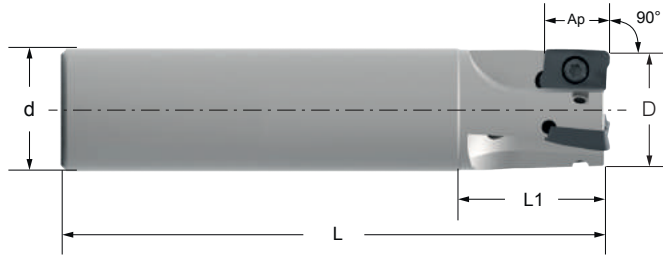

END MILL - APKT 060204 PDTR** / APKT 0602-HF** / APKW 0602-HF**

DESIGNATION	D	D1 HF	d	L	L1	Ap HF	Ap 90°	Z	α HF	α 90°	CATALOG #
LT 752 C-W-D010/2	10	4.7	10	72	16	0.5	5.2	2	3.25	3	M2003098
LT 752 C-W-D012/3	12	6.7	12	80	26	0.5	5.2	3	2.5	2.2	M2003099
LT 752 CL-W-D012/3*	12	6.7	10	120	13.5	0.5	5.2	3	2.5	2.2	M2003078
LT 752 C-W-D016/4	16	10.7	16	90	32	0.5	5.2	4	2	1.5	M2003100
LT 752 CL-W-D016/3*	16	10.7	14	160	13.5	0.5	5.2	3	2	1.5	M2003105
LT 752 C-W-D020/5	20	14.7	20	100	40	0.5	5.2	5	1.25	1.15	M2003101
LT 752 CL-W-D020/4*	20	14.7	18	200	13.5	0.5	5.2	4	1.25	1.15	M2003080
LT 752 C-W-D025/7	25	19.7	20	120	40	0.5	5.2	7	1	0.9	M2003102
LT 752 CL-W-D025/6*	25	19.7	20	220	15	0.5	5.2	6	1	0.9	M2003081

*Available Q3 2017

SCREW M2001640
 SCREW DRIVER HANDLE M2002922
 PRESET ADAPTER 0.4NM M2002923
 TORX PLUS BIT M2003064

END MILL - APKT 100308 PDTR / APKT 100304 PDTR / APKT 100312 PDTR / APKT 100316 PDTR

DESIGNATION	D	d	L	L1	Ap	Z	α	CATALOG #
LT 741 C-W-D016/2	16	16	100	25	9	2	12	M2002806
LT 741 CL-W-D016/2	16	16	150	35	9	2	12	M2002817
LT 741 C-W-D018/2	18	20	100	30	9	2	12	M2002807
LT 741 C-W-D020/3	20	20	100	30	9	3	7	M2002808
LT 741 CL-W-D020/3	20	20	150	35	9	3	7	M2002818
LT 741 C-W-D022/3	22	20	100	30	9	3	7	M2002809
LT 741 C-W-D025/3	25	25	120	30	9	3	5	M2002810
LT 741 C-W-D025/4	25	25	120	30	9	4	5	M2002811
LT 741 CL-W-D025/4	25	25	200	40	9	4	5	M2002819
LT 741 C-W-D028/4	28	25	120	30	9	4	2	M2002812
LT 741 C-W-D030/4	30	25	120	30	9	4	2	M2002813
LT 741 W-W-D032/5	32	32	120	30	9	5	3	M2002814
LT 741 WL-W-D032/4	32	32	200	40	9	4	3	M2002820

SCREW M2002181
 KEY M2000601

** Due to the small size of these inserts, using a pre-set torque screw driver (0.4Nm) at all times is recommended. It is also recommended that during mounting, the insert should be held in place with a finger.

CUTTERS APKT

END MILL - APKT 100332/40

DESIGNATION	D	d	L	L1	Ap	Z	α	CATALOG #
LT 745 W-W-D016/2*	16	16	100	25	9	2	10	M2001587
LT 745 WL-W-D016/2*	16	16	150	35	9	2	10	M2001849
LT 745 W-W-D020/3*	20	20	100	30	9	3	7	M2001589
LT 745 WL-W-D020/3*	20	20	150	35	9	3	7	M2001850
LT 745 W-W-D025/3*	25	25	120	30	9	3	5	M2001591
LT 745 WL-W-D025/4*	25	25	200	40	9	4	5	M2001851
LT 745 WL-W-D032/4*	32	32	200	40	9	4	3	M2001852
LT 745 W-W-D032/5*	32	32	120	30	9	5	3	M2001848

*On Request

SCREW M2002181
KEY M2000601

END MILL - APKT 160408 PDTR

DESIGNATION	D	d	L	L1	Ap	Z	α	CATALOG #
LT 731 W-W-D025/2	25	25	100	44	15	2	5	M2002966
LT 731 WL-W-D025/2	25	25	220	90	15	2	5	M2002965
LT 731 W-W-D032/3	32	32	110	50	15	3	3	M2002968
LT 731 WL-W-D032/3	32	32	220	90	15	3	3	M2002967
LT 731 W-W-D040/4	40	32	115	50	15	4	2.5	M2002970
LT 731 WL-W-D040/4	40	32	220	90	15	4	2.5	M2002969

SCREW M2000597
KEY M2000602

END MILL - APKT 1705

DESIGNATION	D	d	L	L1	Ap	Z	α	CATALOG #
LT 737 W-W-D025/2	25	20	100	32	16	2	5	M2001833
LT 737 WL-W-D025/2	25	25	210	40	16	2	5	M2001836
LT 737 W-W-D032/3	32	32	110	40	16	3	3	M2001834
LT 737 WL-W-D032/3	32	32	200	65	16	3	3	M2001837
LT 737 W-W-D040/4	40	32	115	45	16	4	2.5	M2001835
LT 737 WL-W-D040/4	40	32	200	45	16	4	2.5	M2001982

SCREW M2000597
KEY M2000602

MILLING

CUTTERS APKT

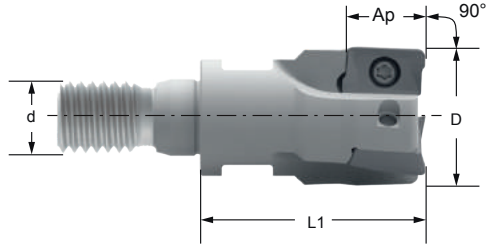

SCREW COUPLING - APKT 060204 PDTR** / APKT 0602-HF** / APKW 0602-HF**

DESIGNATION	D	D1 HF	d	L1	Ap HF	Ap 90°	Z	α HF	α 90°	CATALOG #
LT 752 S-W-D010/2*	10	4.7	M6	19	0.5	5.2	2	3.25	3.0	M2003087
LT 752 S-W-D012/3*	12	6.7	M6	19	0.5	5.2	3	2.5	2.2	M2003088
LT 752 S-W-D016/4*	16	10.7	M8	22	0.5	5.2	4	2.0	1.5	M2003089
LT 752 S-W-D020/5*	20	14.7	M10	25	0.5	5.2	5	1.25	1.15	M2003090
LT 752 S-W-D025/7*	25	19.7	M12	25	0.5	5.2	7	1.0	0.9	M2003091
LT 752 S-W-D032/8*	32	26.7	M16	30	0.5	5.2	8	0.7	0.7	M2003094

*Available Q3 2017

SCREW	M2001640
SCREW DRIVER HANDLE	M2002922
PRESET ADAPTER 0.4NM	M2002923
TORX PLUS BIT	M2003064

SCREW COUPLING - APKT 100308 PDTR / 100304 PDTR / 100312 PDTR / 100316 PDTR

DESIGNATION	D	d	L1	Ap	Z	α	CATALOG #
LT 741 S-W-D016/2	16	M8	25	9	2	10	M2002962
LT 741 S-W-D020/3	20	M10	30	9	3	7	M2002963
LT 741 S-W-D025/4	25	M12	35	9	4	5	M2002964

SCREW	M2002181
KEY	M2000601

** Due to the small size of these inserts, using a pre-set torque screw driver (0.4Nm) at all times is recommended. It is also recommended that during mounting, the insert should be held in place with a finger.

CUTTERS APKT

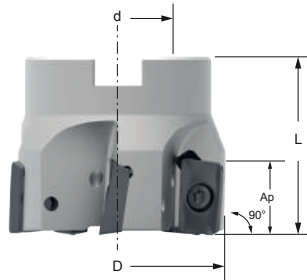

SHELL MILL - APKT 100308 PDTR / 100304 PDTR / 100312 PDTR / 100316 PDTR

DESIGNATION	D	d	L	Ap	Z	α	CATALOG #
LT 741 M-W-D040/6	40	16	40	9	6	2.5	M2002798
LT 741 M-W-D050/7	50	22	40	9	7	2.2	M2002799
LT 741 M-W-D063/8	63	22	40	9	8	1.8	M2002800
LT 741 M-W-D080/11*	80	27	50	9	11	1.4	M2002801

*On Request

SCREW
KEY M2002181
M2000601

SHELL MILL - APKT 100332/40

DESIGNATION	D	d	L	Ap	Z	α	CATALOG #
LT 745 M-W-D040/6*	40	22	40	9	6	2.0	M2001580
LT 745 M-W-D050/7*	50	22	40	9	7	1.8	M2001581

*On Request

SCREW
KEY M2002181
M2000601

SHELL MILL - APKT 160408 PDTR

DESIGNATION	D	d	L	Ap	Z	α	CATALOG #
LT 731 M-W-D040/4	40	16	40	15	4	2.5	M2002971
LT 731 M-W-D050/5	50	22	40	15	5	2.2	M2002972
LT 731 M-W-D063/6	63	22	40	15	6	1.8	M2002973
LT 731 M-W-D080/7	80	27	50	15	7	1.4	M2002974
LT 731 M-W-D100/8	100	32	50	15	8	1.1	M2002975
LT 731 M-W-D125/9	125	40	63	15	9	0.8	M2002976
LT 731 M-D-D160/10*	160	40	63	15	10	N/A	M2002977

*On Request

SCREW
KEY M2000597
M2000602

SHELL MILL - APKT 1705

DESIGNATION	D	d	L	Ap	Z	α	CATALOG #
LT 737 M-W-D040/4	40	16	40	16	4	2.5	M2001838
LT 737 M-W-D050/5	50	22	40	16	5	2.2	M2001839
LT 737 M-W-D063/6	63	22	40	16	6	1.8	M2001841
LT 737 M-W-D080/7	80	27	50	16	7	1.4	M2001842
LT 737 M-W-D100/7	100	32	50	16	7	1.1	M2001843
LT 737 M-W-D125/9	125	40	63	16	9	0.8	M2001844

SCREW
KEY M2000597
M2000602

ADKT



MAGIA

DESIGNATION	GRADE	RADIUS (mm)	CUTTING EDGES	CUTTER LINE	MATERIAL RECOMMENDATION	CATALOG #
ADKT 1505 PDTR	LT 3000	0.96	2	LT 790		M0002209

ALPHA

DESIGNATION	GRADE	RADIUS (mm)	CUTTING EDGES	CUTTER LINE	MATERIAL RECOMMENDATION	CATALOG #
ADKT 1505 PDTR	LT 30	0.96	2	LT 790		M0001573

MATERIAL GROUP

STEEL	HIGH TEMP ALLOYS
STAINLESS STEEL	HARDENED MATERIAL
CAST IRON	ALU(>8%Si)

CUTTING SPEED



DOC / FEED



ORDERING EXAMPLE

QUANTITY	10 PIECES
DESIGNATION + GRADE	CCMT 060204 NN LT 1000
CATALOG NUMBER	T0001888

CUTTERS ADKT

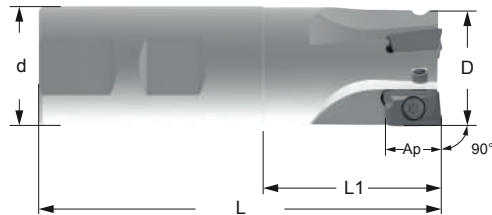

END MILL - ADKT 1505

DESIGNATION	D	d	L	L1	Ap	Z	α	CATALOG #
LT 790 W-W-D025/2*	25	25	100	44	15	2	5.0	M2001613
LT 790 W-W-D032/3*	32	32	110	50	15	3	3.0	M2001503

*On Request

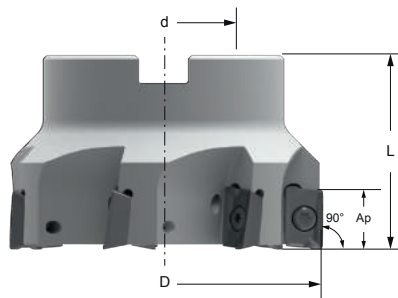
SCREW M2000597
KEY M2000602

SHELL MILL - ADKT 1505

DESIGNATION	D	d	L	Ap	Z	α	CATALOG #
LT 790 M-W-D040/4*	40	16	40	15	4	2.5	M2001615
LT 790 M-W-D050/5*	50	22	40	15	5	2.2	M2001504
LT 790 M-W-D063/6*	63	22	40	15	6	1.8	M2001616
LT 790 M-W-D080/7*	80	27	50	15	7	1.4	M2001617

*On Request

SCREW M2000597
KEY M2000602

A O M T



MAGIA

DESIGNATION	GRADE	RADIUS (mm)	CUTTING EDGES	CUTTER LINE	MATERIAL RECOMMENDATION	CATALOG #
AOMT 123608 PETR	LT 3000	0.70	2	LT 720		M0002210

ALPHA

DESIGNATION	GRADE	RADIUS (mm)	CUTTING EDGES	CUTTER LINE	MATERIAL RECOMMENDATION	CATALOG #
AOMT 123608 PETR	LT 30	0.70	2	LT 720		M0001640

MATERIAL GROUP

STEEL	HIGH TEMP ALLOYS
STAINLESS STEEL	HARDENED MATERIAL
CAST IRON	ALU(>8%Si)

CUTTING SPEED



p. 226

DOC / FEED



see index p. 335

ORDERING EXAMPLE

QUANTITY	10 PIECES
DESIGNATION + GRADE	CCMT 060204 NN LT 1000
CATALOG NUMBER	T0001888

CUTTERS AOMT

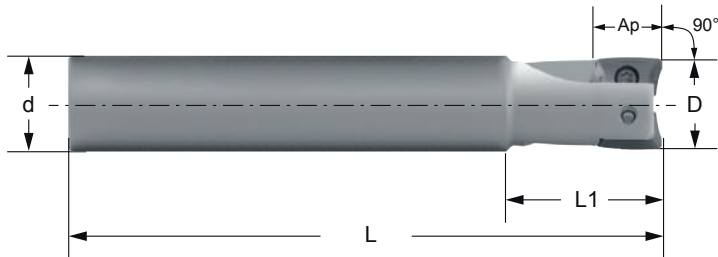

END MILL - AOMT 123608

DESIGNATION	D	d	L	L1	Ap	Z	α	CATALOG #
LT 720 W-W-D016/2*	16	16	85	22	10	2	12	M2001781
LT 720 W-W-D025/3*	25	20	90	25	10	3	7	M2001783

*On Request

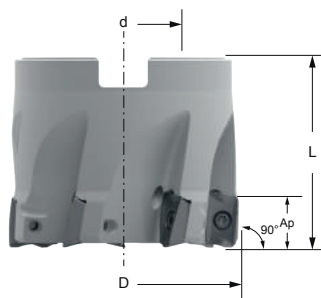
SCREW M2002181
KEY M2000601

SHELL MILL - AOMT 123608

DESIGNATION	D	d	L	Ap	Z	α	CATALOG #
LT 720 M-W-D040/6*	40	22	40	10	6	2.5	M2001785
LT 720 M-W-D050/7*	50	22	40	10	7	2.2	M2001821

*On Request

SCREW M2002181
KEY M2000601

APMT



MAGIA

DESIGNATION	GRADE	RADIUS (mm)	CUTTING EDGES	CUTTER LINE	MATERIAL RECOMMENDATION	CATALOG #
APMT 0903 PDTR	LT 3000	0.40	2	-		M0004161
APMT 1135 PDTR	LT 3000	0.70	2	LT 755		M0002216
APMT 1604 PDTR	LT 3000	0.66	2	LT 760		M0002183
APMT 160408 PDTR	LT 3000	0.70	2	LT 760		M0002218

ALPHA

DESIGNATION	GRADE	RADIUS (mm)	CUTTING EDGES	CUTTER LINE	MATERIAL RECOMMENDATION	CATALOG #
APMT 0903 PDTR	LT 30	0.40	2	-		M0000663
APMT 1135 PDTR	LT 30	0.70	2	LT 755		M0001133
APMT 1604 PDTR	LT 30	0.66	2	LT 760		M0001134
APMT 160408 PDTR	LT 30	0.70	2	LT 760		M0001733

CUTTERS APMT

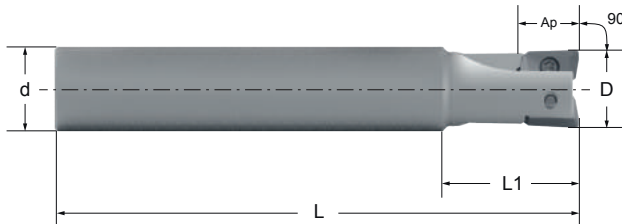

END MILL - APMT 1135

DESIGNATION	D	d	L	L1	Ap	Z	α	CATALOG #
LT 755 W-W-D010/1*	10	16	100	25	9	1	5	M2001652
LT 755 W-W-D012/1*	12	16	100	25	9	1	5	M2001653
LT 755 WL-W-D016/2*	16	16	150	30	9	2	12	M2001658
LT 755 W-W-D016/2*	16	16	120	30	9	2	12	M2001654
LT 755 WL-W-D020/2*	20	20	150	35	9	2	7	M2001659
LT 755 W-W-D020/3*	20	20	120	35	9	3	7	M2001655
LT 755 WL-W-D025/4*	25	25	200	40	9	4	5	M2001660
LT 755 W-W-D025/4*	25	25	150	40	9	4	5	M2001656
LT 755 WL-W-D032/4*	32	25	200	40	9	5	3	M2001661
LT 755 W-W-D032/5*	32	25	150	40	9	5	3	M2001657

*On Request

SCREW M2002778
KEY M2002912

MATERIAL GROUP



CUTTING SPEED



p. 226

DOC / FEED



see index p. 335

ORDERING EXAMPLE

QUANTITY 10 PIECES
DESIGNATION + GRADE CCMT 060204 NN LT 1000
CATALOG NUMBER T0001888

CUTTERS APMT

END MILL - APMT 1604

DESIGNATION	D	d	L	L1	Ap	Z	α	CATALOG #
LT 760 W-W-D025/2*	25	25	150	50	15	2	5	M2001662
LT 760 WL-W-D025/2*	25	25	200	70	15	2	5	M2001665
LT 760 W-W-D032/3*	32	32	200	100	15	3	3	M2001663
LT 760 WL-W-D032/3*	32	32	250	100	15	3	3	M2001666
LT 760 W-W-D040/4*	40	32	200	100	15	4	2.5	M2001664
LT 760 WL-W-D040/4*	40	32	250	100	15	4	2.5	M2001667

*On Request

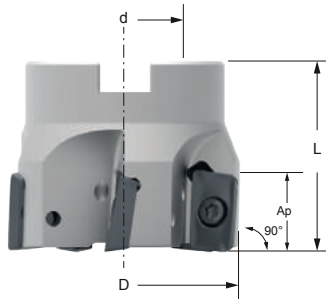
SCREW M2000597
KEY M2000602

SHELL MILL - APMT 1604

DESIGNATION	D	d	L	Ap	Z	α	CATALOG #
LT 760 M-W-D050/5*	50	22	40	15	5	2.2	M2001668
LT 760 M-W-D063/6*	63	22	40	15	6	1.8	M2001669
LT 760 M-W-D080/7*	80	27	50	15	7	1.4	M2001670
LT 760 M-W-D100/8*	100	32	50	15	8	1.1	M2001671
LT 760 M-W-D125/9*	125	40	63	15	9	0.8	M2001672

*On Request

SCREW M2000597
KEY M2000602

TPKN



MAGIA

DESIGNATION	GRADE	RADIUS (mm)	CUTTING EDGES	CUTTER LINE	MATERIAL RECOMMENDATION	CATALOG #
TPKN 1603 PDTR	LT 3000	1.2	3	LT 310		M0004040
TPKN 2204 PDTR	LT 3000	1.2	3	LT 320		M0004041

ALPHA

DESIGNATION	GRADE	RADIUS (mm)	CUTTING EDGES	CUTTER LINE	MATERIAL RECOMMENDATION	CATALOG #
TPKN 1603 PDTR	LT 30	1.2	3	LT 310		M0000051
TPKN 2204 PDTR	LT 30	1.2	3	LT 320		M0000052

TPKR



MAGIA

DESIGNATION	GRADE	RADIUS (mm)	CUTTING EDGES	CUTTER LINE	MATERIAL RECOMMENDATION	CATALOG #
TPKR 1603 PDTR	LT 3000	1.20	3	LT 310		M0004042
TPKR 2204 PDTR	LT 3000	1.20	3	LT 320		M0004043

ALPHA

DESIGNATION	GRADE	RADIUS (mm)	CUTTING EDGES	CUTTER LINE	MATERIAL RECOMMENDATION	CATALOG #
TPKR 1603 PDTR	LT 30	1.20	3	LT 310		M0000053
TPKR 2204 PDTR	LT 30	1.20	3	LT 320		M0000983

MATERIAL GROUP	
STEEL	HIGH TEMP ALLOYS
STAINLESS STEEL	HARDENED MATERIAL
CAST IRON	ALU(>8%Si)

CUTTING SPEED
p. 226

DOC / FEED
see index p. 335

ORDERING EXAMPLE	
QUANTITY	10 PIECES
DESIGNATION + GRADE	CCMT 060204 NN LT 1000
CATALOG NUMBER	T0001888

CUTTERS TPKN / TPKR

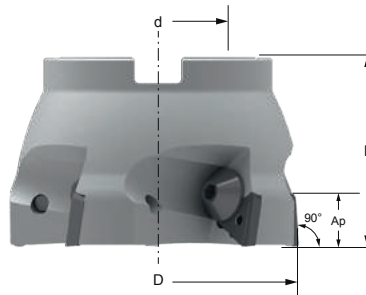

SHELL MILL - TPKN 1603 PDTR / TPKR 1603 PDTR

DESIGNATION	D	d	L	A_p	Z	CATALOG #
LT 310 M-D-D063/4*	63	22	50	13	4	M2000699
LT 310 M-D-D080/5*	80	27	50	13	5	M2000700
LT 310 M-D-D100/6*	100	32	50	13	6	M2000701
LT 310 M-D-D125/6*	125	40	63	13	6	M2000702

*On Request

SCREW
KEY M2002951
T2002786

SHELL MILL - TPKN 2204 PDTR / TPKR 2204 PDTR

DESIGNATION	D	d	L	A_p	Z	CATALOG #
LT 320 M-D-D080/4*	80	27	50	18	4	M2000703
LT 320 M-D-D100/5*	100	32	50	18	5	M2000704
LT 320 M-D-D125/6*	125	40	63	18	6	M2000705
LT 320 M-D-D160/7*	160	40	63	18	7	M2000706

*On Request

SCREW
KEY M2002952
T2002786

TPUN



MAGIA

DESIGNATION	GRADE	RADIUS (mm)	CUTTING EDGES	CUTTER LINE	MATERIAL RECOMMENDATION	CATALOG #
TPUN 160308	LT 3000	0.80	3	LT 310	■ ■ ■	M0004044

ALPHA

DESIGNATION	GRADE	RADIUS (mm)	CUTTING EDGES	CUTTER LINE	MATERIAL RECOMMENDATION	CATALOG #
TPUN 160308	LT 30	0.80	3	LT 310	■ ■ ■	M0000054

CUTTERS TPUN

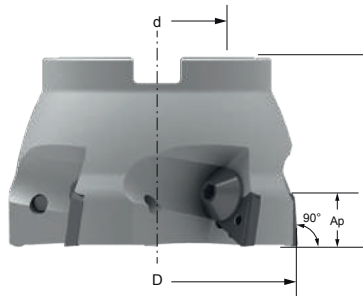

SHELL MILL - TPUN 160308

DESIGNATION	D	d	L	Ap	Z	CATALOG #
LT 310 M-D-D063/4*	63	22	50	13	4	M2000699
LT 310 M-D-D080/5*	80	27	50	13	5	M2000700
LT 310 M-D-D100/6*	100	32	50	13	6	M2000701
LT 310 M-D-D125/6*	125	40	63	13	6	M2000702

*On Request

SCREW M2002951
KEY T2002786

MATERIAL GROUP

- STEEL
- STAINLESS STEEL
- CAST IRON
- HIGH TEMP ALLOYS
- HARDENED MATERIAL
- ALU(>8%Si)

CUTTING SPEED



DOC / FEED



ORDERING EXAMPLE

QUANTITY 10 PIECES
DESIGNATION + GRADE CCMT 060204 NN LT 1000
CATALOG NUMBER T0001888

LDMT



ALPHA

DESIGNATION	GRADE	RADIUS (mm)	CUTTING EDGES	CUTTER LINE	MATERIAL RECOMMENDATION	CATALOG #
LDMT 1504 PDSR	LT 30	0.74	2	LT 770		M0001772

CUTTERS LDMT

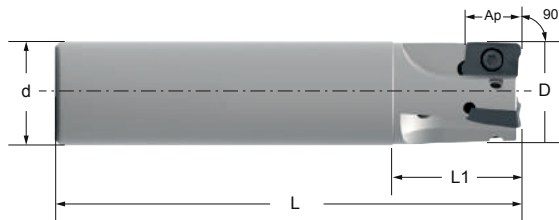

END MILL - LDMT 1504

DESIGNATION	D	d	L	L1	Ap	Z	α	CATALOG #
LT 770 W-W-D025/2*	25	25	100	44	15	2	5	M2001822
LT 770 W-W-D032/3*	32	35	110	50	15	3	3	M2001823
LT 770 W-W-D040/4*	40	32	115	45	15	4	2.5	M2001824

*On Request

 SCREW M2001418
 KEY M2000602

MATERIAL GROUP



CUTTING SPEED



DOC / FEED



ORDERING EXAMPLE

QUANTITY	10 PIECES
DESIGNATION + GRADE	CCMT 060204 NN LT 1000
CATALOG NUMBER	T0001888

S P M T



MAGIA

DESIGNATION	GRADE	RADIUS (mm)	CUTTING EDGES	CUTTER LINE	MATERIAL RECOMMENDATION	CATALOG #
SPMT 12T308	LT 3000	0.80	4	-		M0003420

ALPHA

DESIGNATION	GRADE	RADIUS (mm)	CUTTING EDGES	CUTTER LINE	MATERIAL RECOMMENDATION	CATALOG #
SPMT 12T308	LT 30	0.80	4	-		M0001226

MATERIAL GROUP

STEEL	HIGH TEMP ALLOYS
STAINLESS STEEL	HARDENED MATERIAL
CAST IRON	ALU(>8%Si)

CUTTING SPEED



DOC / FEED



ORDERING EXAMPLE

QUANTITY	10 PIECES
DESIGNATION + GRADE	CCMT 060204 NN LT 1000
CATALOG NUMBER	T0001888

HIGH FEED MILLING

HIGH FEED
MILLING

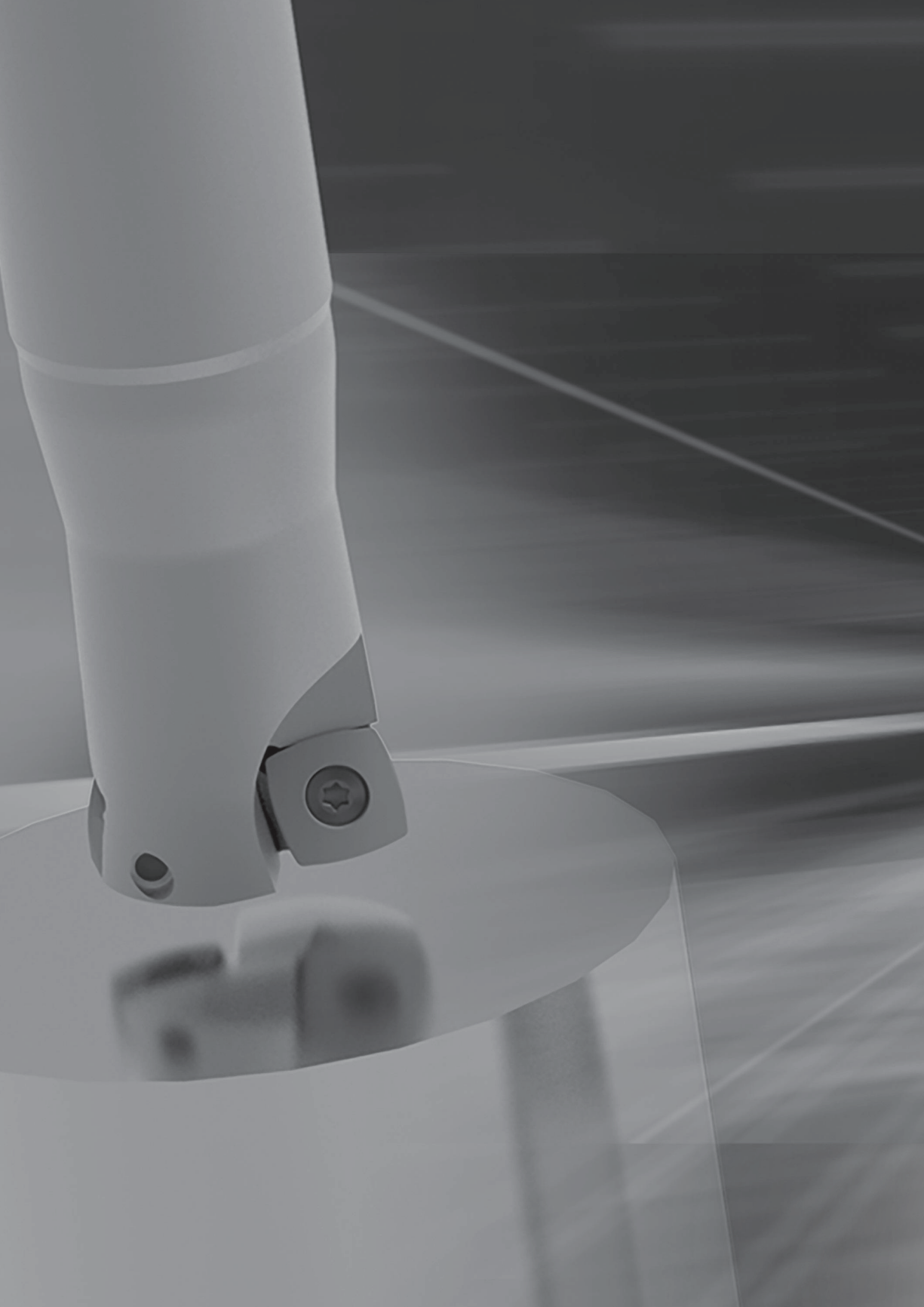

SOLUTIONS FOR RAPID MATERIAL REMOVAL

BOOST PRODUCTIVITY, CUT COSTS

Using a shallow depth of cut with a small approach angle ensures the cutting forces are directed towards the machine spindle in the axial direction, which results in greater tool stability.

- More stable cut (less vibrations)
- Excellent metal removal rate
- Potential increase in feed rates up to 10 times the normal rates

As a leading company in milling operations, Lamina is continually expanding its High Feed line. From diameter 3mm to 80mm, we offer the solution to increase productivity in a wide variety of milling applications and workpiece materials.

A P K T



MAGIA PRO

DESIGNATION	GRADE	R _{PROG}	CUTTING EDGES	CUTTER LINE	MATERIAL RECOMMENDATION	CATALOG #
APKT 0602-HF	LT 3130	1.20	2	LT 752		M0004469

MAGIA

DESIGNATION	GRADE	RADIUS (mm)	CUTTING EDGES	CUTTER LINE	MATERIAL RECOMMENDATION	CATALOG #
APKT 0602-HF	LT 3000	1.20	2	LT 752		M0004296

A P K W



MAGIA PRO

DESIGNATION	GRADE	R _{PROG}	CUTTING EDGES	CUTTER LINE	MATERIAL RECOMMENDATION	CATALOG #
APKW 0602-HF	LT 3130	1.20*	2	LT 752		M0004472

MAGIA

DESIGNATION	GRADE	RADIUS (mm)	CUTTING EDGES	CUTTER LINE	MATERIAL RECOMMENDATION	CATALOG #
APKW 0602-HF	LT 3000	1.20	2	LT 752		M0004297

MATERIAL GROUP

STEEL	HIGH TEMP ALLOYS
STAINLESS STEEL	HARDENED MATERIAL
CAST IRON	ALU(>8%Si)

CUTTING SPEED



DOC / FEED



ORDERING EXAMPLE

QUANTITY	10 PIECES
DESIGNATION + GRADE	CCMT 060204 NN LT 1000
CATALOG NUMBER	T0001888

CUTTERS APKT / APKW

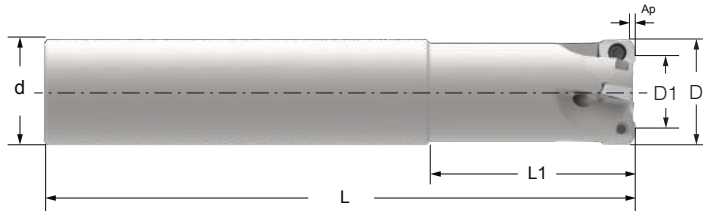

END MILL - APKT 060204** / APKT 0602-HF** / APKW 0602-HF**

DESIGNATION	D	D1 HF	d	L	L1	Ap HF	Ap 90°	Z	α HF	α 90°	CATALOG #
LT 752 C-W-D010/2	10	4.7	10	72	16	0.5	5.2	2	3.25	3.0	M2003098
LT 752 C-W-D012/3	12	6.7	12	80	26	0.5	5.2	3	2.5	2.2	M2003099
LT 752 CL-W-D012/3*	12	6.7	10	120	13.5	0.5	5.2	3	2.5	2.2	M2003078
LT 752 C-W-D016/4	16	10.7	16	90	32	0.5	5.2	4	2.0	1.5	M2003100
LT 752 CL-W-D016/3*	16	10.7	14	160	13.5	0.5	5.2	3	2.0	1.5	M2003105
LT 752 C-W-D020/5	20	14.7	20	100	40	0.5	5.2	5	1.25	1.15	M2003101
LT 752 CL-W-D020/4*	20	14.7	18	200	13.5	0.5	5.2	4	1.25	1.15	M2003080
LT 752 C-W-D025/7	25	19.7	20	120	40	0.5	5.2	7	1.0	0.9	M2003102
LT 752 CL-W-D025/6*	25	19.7	20	220	15	0.5	5.2	6	1.0	0.9	M2003081

* Available Q3 2017

SCREW M2001640
 SCREW DRIVER HANDLE M2002922
 PRESET ADAPTER 0.4NM M2002923
 TORX PLUS BIT M2003064

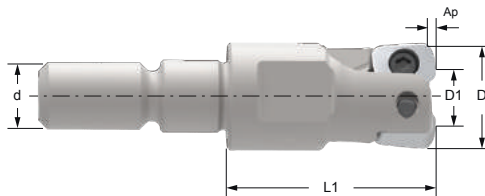

SCREW COUPLING - APKT 060204** / APKT 0602-HF** / APKW 0602-HF**

DESIGNATION	D	D1 HF	d	L1	Ap HF	Ap 90°	Z	α HF	α 90°	CATALOG #
LT 752 S-W-D010/2*	10	4.7	M6	19	0.5	5.2	2	3.25	3.0	M2003087
LT 752 S-W-D012/3*	12	6.7	M6	19	0.5	5.2	3	2.5	2.2	M2003088
LT 752 S-W-D016/4*	16	10.7	M8	22	0.5	5.2	4	2.0	1.5	M2003089
LT 752 S-W-D020/5*	20	14.7	M10	25	0.5	5.2	5	1.25	1.15	M2003090
LT 752 S-W-D025/7*	25	19.7	M12	25	0.5	5.2	7	1.0	0.9	M2003091
LT 752 S-W-D032/8*	32	26.7	M16	30	0.5	5.2	8	0.7	0.7	M2003094

* Available Q3 2017

SCREW M2001640
 SCREW DRIVER HANDLE M2002922
 PRESET ADAPTER 0.4NM M2002923
 TORX PLUS BIT M2003064

** Due to the small size of these inserts, using a pre-set torque screw driver (0.4Nm) at all times is recommended. It is also recommended that during mounting, the insert should be held in place with a finger.

S D K W



MAGIA PRO

DESIGNATION	GRADE	R _{PROG}	CUTTING EDGES	CUTTER LINE	MATERIAL RECOMMENDATION	CATALOG #
SDKW 0904-HF	LT 3130	2.0	4	LT 902		M0004482
SDKW 1205-HF	LT 3130	2.5	4	LT 903		M0004483

MAGIA

DESIGNATION	GRADE	R _{PROG}	CUTTING EDGES	CUTTER LINE	MATERIAL RECOMMENDATION	CATALOG #
SDKW 0904-HF	LT 3000	2.0	4	LT 902		M0004263
SDKW 1205-HF	LT 3000	2.5	4	LT 903		M0004224

S D K X

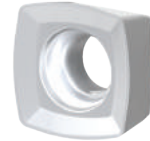

MAGIA PRO

DESIGNATION	GRADE	R _{PROG}	CUTTING EDGES	CUTTER LINE	MATERIAL RECOMMENDATION	CATALOG #
SDKX 0904-HF	LT 3130	2.0	4	LT 902		M0004484
SDKX 1205-HF	LT 3130	2.5	4	LT 903		M0004485

MAGIA

DESIGNATION	GRADE	R _{PROG}	CUTTING EDGES	CUTTER LINE	MATERIAL RECOMMENDATION	CATALOG #
SDKX 0904-HF	LT 3000	2.0	4	LT 902		M0003412
SDKX 1205-HF	LT 3000	2.5	4	LT 903		M0003413

MATERIAL GROUP	
STEEL	HIGH TEMP ALLOYS
STAINLESS STEEL	HARDENED MATERIAL
CAST IRON	ALU(>8%Si)

CUTTING SPEED
 p. 226

DOC / FEED
 see index p. 335

ORDERING EXAMPLE	
QUANTITY	10 PIECES
DESIGNATION + GRADE	CCMT 060204 NN LT 1000
CATALOG NUMBER	T0001888

CUTTERS SDKX / SDKW

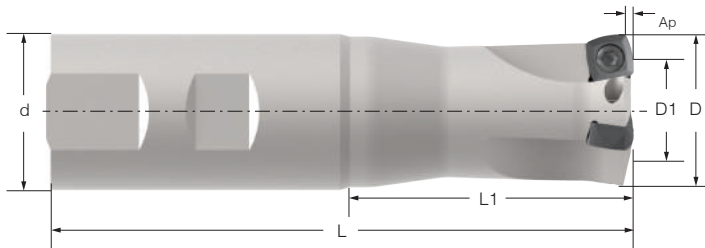

END MILL - SDKW 0904-HF / SDKX 0904-HF

DESIGNATION	D	D1	d	L	L1	Ap	Z	α	CATALOG #
LT 902 W-W-D025/2	25	9.6	25	120	60	1.5	2	2	M2003351
LT 902 WL-W-D025/2	25	9.6	25	200	60	1.5	2	2	M2003350
LT 902 W-W-D032/3	32	16.6	32	120	60	1.5	3	2	M2003353
LT 902 WL-W-D032/3	32	16.6	32	200	60	1.5	3	2	M2003352

SCREW M2001420
KEY M2000602

END MILL - SDKW 1205-HF / SDKX 1205 HF

DESIGNATION	D	D1	d	L	L1	Ap	Z	α	CATALOG #
LT 903 W-W-D032/2	32	11.0	32	120	60	2	2	2	M2003366
LT 903 WL-W-D032/2	32	11.0	32	200	60	2	2	2	M2003365

SCREW M2000597
KEY M2000602

MILLING

CUTTERS SDKX / SDKW

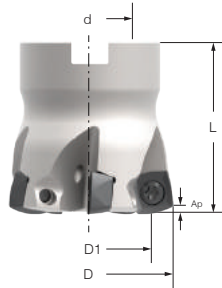

SHELL MILL - SDKX 0904-HF / SDKW 0904-HF

DESIGNATION	D	D1	d	L	Ap	Z	α	CATALOG #
LT 902 M-W-D040/5	40	24.6	16	40	1.5	5	0.8	M2003341
LT 902 M-W-D042/5	42	26.6	16	40	1.5	5	0.8	M2003342
LT 902 M-W-D050/6	50	34.6	22	40	1.5	6	0.7	M2003343
LT 902 M-W-D052/6	52	36.6	22	40	1.5	6	0.7	M2003344
LT 902 M-W-D063/6	63	47.6	22	40	1.5	6	0.6	M2003345
LT 902 M-W-D066/6	66	50.6	22	40	1.5	6	0.6	M2003346

SCREW M2001420
KEY M2000602

SHELL MILL - SDKX 1205-HF / SDKW 1205-HF

DESIGNATION	D	D1	d	L	Ap	Z	α	CATALOG #
LT 903 M-W-D050/4	50	29.0	22	40	2	4	0.8	M2003661
LT 903 M-W-D050/5	50	29.0	22	40	2	5	0.8	M2003357
LT 903 M-W-D052/5	52	31.0	22	40	2	5	0.8	M2003358
LT 903 M-W-D063/5	63	42.0	22	40	2	5	0.6	M2003662
LT 903 M-W-D063/6	63	42.0	22	40	2	6	0.6	M2003360
LT 903 M-W-D066/6	66	45.0	22	40	2	6	0.6	M2003361
LT 903 M-W-D066/6-D27	66	45.0	27	40	2	6	0.6	M2004168
LT 903 M-W-D080/6	80	59.0	27	50	2	6	0.4	M2003663
LT 903 M-W-D080/8	80	59.0	27	50	2	8	0.4	M2003452

SCREW M2000597
KEY M2000602

CUTTERS SDKX / SDKW

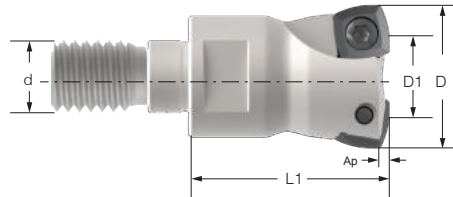

SCREW COUPLING - SDKX 0904-HF / SDKW 0904-HF

DESIGNATION	D	D1	d	L1	Ap	Z	α	CATALOG #
LT 902 S-W-D025/2	25	9.6	M12	35	1.5	2	2.0	M2003347
LT 902 S-W-D032/3	32	16.6	M16	35	1.5	3	1.5	M2003348
LT 902 S-W-D035/4	35	19.6	M16	35	1.5	4	0.8	M2003349

SCREW M2001420
KEY M2000602

SCREW COUPLING - SDKX 1205-HF / SDKW 1205-HF

DESIGNATION	D	D1	d	L1	Ap	Z	α	CATALOG #
LT 903 S-W-D032/2	32	11.0	M16	35	2	2	2.0	M2003362
LT 903 S-W-D035/2	35	14.0	M16	35	2	2	1.5	M2003364
LT 903 S-W-D040/4	40	19	M16	40	2	4	0.8	M2003354
LT 903 S-W-D042/4*	42	21	M16	35	2	4	0.8	M2003356

*On Request

SCREW M2000597
KEY M2000602

**With Lamina you have
the right tool, at the right
time, all the time**



COPY MILLING



COPY MILLING SOLUTIONS

ADVANTAGES OF ROUND INSERTS

Versatile, used for copying, face milling, ramping, plunging, pocket milling and helical interpolation

STRONGEST INSERT SHAPE

- Reliable even in difficult operations
- Strongest insert shape, no corners to break

ECONOMICAL SOLUTION

- Multiple edges per insert
- 4-8 effective indexes depending on depth of cut

SMOOTH AND STABLE CUT

- Even with long overhangs
- Good distribution of cutting forces

NEW PRODUCTS - RX.. INSERTS WITH LOCATION FLATS

Lamina Technologies introduces three new round insert geometries with indexing flats: RXMT, RXMW and RXMX

- Indexing flats provide for
 - Stable insert mounting
 - Reliable machining of difficult materials in challenging conditions
 - Higher feeds and depths of cut
- Available starting Q3 2017 in Magia LT 3000 and our new Magia Pro LT 3130 for steels and stainless steels

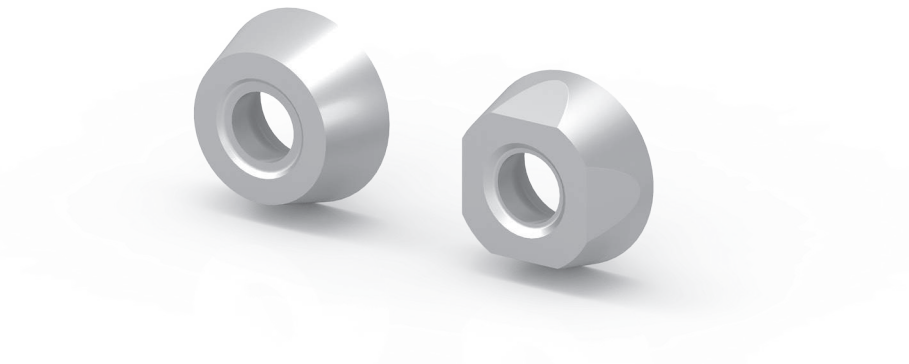

R D M T



MAGIA

DESIGNATION	GRADE	RADIUS (mm)	CUTTING EDGES	CUTTER LINE	MATERIAL RECOMMENDATION	CATALOG #
RDMT 0602 M0	LT 3000	-	-	LT 060		M0003403
RDMT 0702 M0	LT 3000	-	-	LT 070		M0003404
RDMT 0803 M0	LT 3000	-	-	LT 080		M0003405
RDMT 1003 M0	LT 3000	-	-	-		M0002224
RDMT 10T3 M0	LT 3000	-	-	LT 100		M0002225
RDMT 1204 M0	LT 3000	-	-	LT 120		M0002226
RDMT 12T3 M0	LT 3000	-	-	-		M0002227
RDMT 1604 M0	LT 3000	-	-	LT 160		M0003407

ALPHA

DESIGNATION	GRADE	RADIUS (mm)	CUTTING EDGES	CUTTER LINE	MATERIAL RECOMMENDATION	CATALOG #
RDMT 0602 M0	LT 30	-	-	LT 060		M0000035
RDMT 0702 M0	LT 30	-	-	LT 070		M0001882
RDMT 0803 M0	LT 30	-	-	LT 080		M0000037
RDMT 1003 M0	LT 30	-	-	-		M0001875
RDMT 10T3 M0	LT 30	-	-	LT 100		M0000038
RDMT 1204 M0	LT 30	-	-	LT 120		M0000039
RDMT 12T3 M0	LT 30	-	-	-		M0001876
RDMT 1604 M0	LT 30	-	-	LT 160		M0001881

MATERIAL GROUP

STEEL	HIGH TEMP ALLOYS
STAINLESS STEEL	HARDENED MATERIAL
CAST IRON	ALU(>8%Si)

CUTTING SPEED



DOC / FEED



ORDERING EXAMPLE

QUANTITY	10 PIECES
DESIGNATION + GRADE	CCMT 060204 NN LT 1000
CATALOG NUMBER	T0001888

R D M W



MAGIA

DESIGNATION	GRADE	RADIUS (mm)	CUTTING EDGES	CUTTER LINE	MATERIAL RECOMMENDATION	CATALOG #
RDMW 1003 M0	LT 3000	-	-	-		M0004424
RDMW 10T3 M0	LT 3000	-	-	LT 100		M0002228
RDMW 1204 M0	LT 3000	-	-	LT 120		M0003408
RDMW 12T3 M0	LT 3000	-	-	-		M0004425

ALPHA

DESIGNATION	GRADE	RADIUS (mm)	CUTTING EDGES	CUTTER LINE	MATERIAL RECOMMENDATION	CATALOG #
RDMW 1003 M0	LT 30	-	-	-		M0004452
RDMW 10T3 M0	LT 30	-	-	LT 100		M0001550
RDMW 1204 M0	LT 30	-	-	LT 120		M0001551
RDMW 12T3 M0	LT 30	-	-	-		M0004453

R D M X



MAGIA

DESIGNATION	GRADE	RADIUS (mm)	CUTTING EDGES	CUTTER LINE	MATERIAL RECOMMENDATION	CATALOG #
RDMX 1003 M0	LT 3000	-	-	-		M0004426
RDMX 10T3 M0	LT 3000	-	-	LT 100		M0003409
RDMX 1204 M0	LT 3000	-	-	LT 120		M0003410
RDMX 12T3 M0	LT 3000	-	-	-		M0004427

ALPHA

DESIGNATION	GRADE	RADIUS (mm)	CUTTING EDGES	CUTTER LINE	MATERIAL RECOMMENDATION	CATALOG #
RDMX 1003 M0	LT 30	-	-	-		M0004454
RDMX 10T3 M0	LT 30	-	-	LT 100		M0001552
RDMX 1204 M0	LT 30	-	-	LT 120		M0001553
RDMX 12T3 M0	LT 30	-	-	-		M0004455

MATERIAL GROUP

STEEL	HIGH TEMP ALLOYS
STAINLESS STEEL	HARDENED MATERIAL
CAST IRON	ALU(>8%Si)

CUTTING SPEED



DOC / FEED



ORDERING EXAMPLE

QUANTITY	10 PIECES
DESIGNATION + GRADE	CCMT 060204 NN LT 1000
CATALOG NUMBER	T0001888

MILLING

CUTTERS RD..

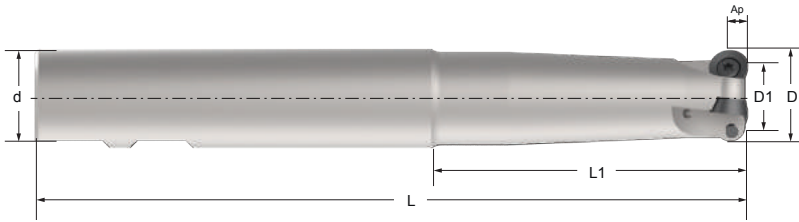

END MILL - RD.. 0602 M0

DESIGNATION	D	D1	d	L	L1	Ap	Z	α	CATALOG #
LT 060 WL-W-D012/2	12	6	16	150	25	3	2	7.0	M2003321
LT 060 WL-W-D016/2	16	10	16	150	25	3	2	6.0	M2000676
LT 060 WL-W-D020/3	20	14	20	180	60	3	3	4.5	M2000677
LT 060 WL-W-D025/3	25	19	25	180	80	3	3	4.0	M2000678

SCREW M2001416

KEY M2002912

END MILL - RD.. 0702 M0

DESIGNATION	D	D1	d	L	L1	Ap	Z	α	CATALOG #
LT 070 WL-W-D016/2	16	9	16	150	25	3.5	2	6.0	M2003336
LT 070 WL-W-D020/3	20	13	20	180	60	3.5	3	4.5	M2003337
LT 070 WL-W-D025/4	25	18	25	180	60	3.5	4	4.0	M2003339

SCREW M2001416

KEY M2002912

END MILL - RD.. 0803 M0

DESIGNATION	D	D1	d	L	L1	Ap	Z	α	CATALOG #
LT 080 WL-W-D016/2	16	8	16	150	25	4	2	12	M2003322
LT 080 WL-W-D020/2	20	12	20	180	42	5	2	12	M2000679
LT 080 WL-W-D025/3	25	17	25	180	60	5	3	8	M2000680
LT 080 WL-W-D032/3	32	24	32	180	80	5	3	5	M2000681

SCREW M2001416

KEY M2002912

END MILL - RD.. 10T3 M0

DESIGNATION	D	D1	d	L	L1	Ap	Z	α	CATALOG #
LT 100 WL-W-D020/2	20	10	20	180	25	5	2	12	M2000683
LT 100 WL-W-D025/3	25	15	25	180	60	5	3	8	M2000684
LT 100 WL-W-D032/3	32	22	32	180	80	5	3	5	M2000685

SCREW M2000597

KEY M2000602

END MILL - RD.. 1204 M0

DESIGNATION	D	D1	d	L	L1	Ap	Z	α	CATALOG #
LT 120 WL-W-D032/3	32	20	32	170	60	6	3	5	M2003323
LT 120 WL-W-D040/4	40	28	32	170	110	6	4	7	M2000687

SCREW M2000597

KEY M2000602

CUTTERS RD..

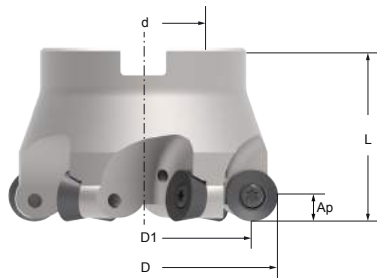

SHELL MILL - RD.. 1204 M0

DESIGNATION	D	D1	d	L	A_p	Z	α	CATALOG #
LT 120 M-W-D040/4	40	28	16	40	6	4	7.0	M2000691
LT 120 M-W-D050/4	50	38	22	50	6	4	5.0	M2001780
LT 120 M-W-D063/5	63	51	22	50	6	5	3.5	M2000689
LT 120 M-W-D080/6	80	68	27	50	6	6	2.5	M2000690
LT 120 M-W-D100/7	100	88	32	50	6	7	2.0	M2000688

SCREW M2000597
KEY M2000602

SHELL MILL - RD.. 1604 M0

DESIGNATION	D	D1	d	L	A_p	Z	α	CATALOG #
LT 160 M-W-D050/4	50	34	22	50	8	4	5.0	M2003331
LT 160 M-W-D063/5	63	47	22	50	8	5	3.5	M2003332
LT 160 M-W-D080/6	80	64	27	50	8	6	2.5	M2003333
LT 160 M-W-D100/7	100	84	32	50	8	7	2.0	M2003334
LT 160 M-W-D125/8	125	109	40	63	8	8	1.0	M2003335

SCREW M2000599
KEY M2000603

R X M T



MAGIA PRO

DESIGNATION	GRADE	RADIUS (mm)	CUTTING EDGES	CUTTER LINE	MATERIAL RECOMMENDATION	CATALOG #
RXMT 10T3 M0	LT 3130	-	4	LT 101		M0004476
RXMT 1204 M0	LT 3130	-	4	LT 121		M0004477

MAGIA

DESIGNATION	GRADE	RADIUS (mm)	CUTTING EDGES	CUTTER LINE	MATERIAL RECOMMENDATION	CATALOG #
RXMT 10T3 M0	LT 3000	-	4	LT 101		M0004171
RXMT 1204 M0	LT 3000	-	4	LT 121		M0004366

R X M W



MAGIA PRO

DESIGNATION	GRADE	RADIUS (mm)	CUTTING EDGES	CUTTER LINE	MATERIAL RECOMMENDATION	CATALOG #
RXMW 10T3 M0	LT 3130	-	4	LT 101		M0004478
RXMW 1204 M0	LT 3130	-	4	LT 121		M0004479

MAGIA

DESIGNATION	GRADE	RADIUS (mm)	CUTTING EDGES	CUTTER LINE	MATERIAL RECOMMENDATION	CATALOG #
RXMW 10T3 M0	LT 3000	-	4	LT 101		M0004371
RXMW 1204 M0	LT 3000	-	4	LT 121		M0004375

MATERIAL GROUP

	STEEL		HIGH TEMP ALLOYS
	STAINLESS STEEL		HARDENED MATERIAL
	CAST IRON		ALU(>8%Si)

CUTTING SPEED



DOC / FEED



ORDERING EXAMPLE

QUANTITY	10 PIECES
DESIGNATION + GRADE	CCMT 060204 NN LT 1000
CATALOG NUMBER	T0001888

R X M X



MAGIA PRO

DESIGNATION	GRADE	RADIUS (mm)	CUTTING EDGES	CUTTER LINE	MATERIAL RECOMMENDATION	CATALOG #
RXXM 10T3 M0	LT 3130	-	4	LT 101		M0004480
RXXM1204 M0	LT 3130	-	4	LT 121		M0004481

MAGIA

DESIGNATION	GRADE	RADIUS (mm)	CUTTING EDGES	CUTTER LINE	MATERIAL RECOMMENDATION	CATALOG #
RXXM 10T3 M0	LT 3000	-	4	LT 101		M0004373
RXXM1204 M0	LT 3000	-	4	LT 121		M0004377

MATERIAL GROUP

	STEEL		HIGH TEMP ALLOYS
	STAINLESS STEEL		HARDENED MATERIAL
	CAST IRON		ALU(>8%Si)

CUTTING SPEED



p. 226

DOC / FEED



see index p. 335

ORDERING EXAMPLE

QUANTITY	10 PIECES
DESIGNATION + GRADE	CCMT 060204 NN LT 1000
CATALOG NUMBER	T0001888

MILLING

CUTTERS RX..

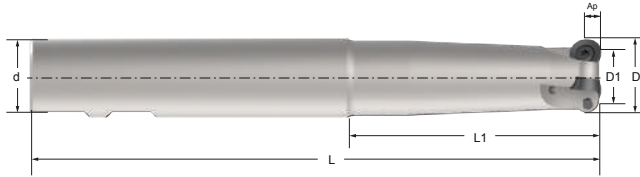

END MILL RX.. - 10T3 M0

DESIGNATION	D	D1	d	L	L1	A_p	Z	α	CATALOG #
LT 101 C-W-D025/3	25	15	25	117	60	5	3	10.0	M2001562
LT 101 C-W-D032/4	32	22	32	131	70	5	4	8.5	M2001563
LT 101 CL-W-D032/3	32	22	32	181	70	5	3	8.5	M2001564
LT 101 W-W-D025/3	25	15	25	92	35	5	3	10.0	M2001565
LT 101 W-W-D032/4	32	22	32	101	40	5	4	8.5	M2001566
LT 101 WL-W-D032/3	32	22	32	181	120	5	3	8.5	M2001567

SCREW M2003786
KEY M2000602

END MILL RX.. - 1204 M0

DESIGNATION	D	D1	d	L	L1	A_p	Z	α	CATALOG #
LT 121 C-W-D040/4	40	28.0	40	141	70	6	4	7.5	M2001853
LT 121 W-W-D040/3	40	28.0	40	111	40	6	4	7.5	M2001854

SCREW M2000597
KEY M2000602

CUTTERS RX..

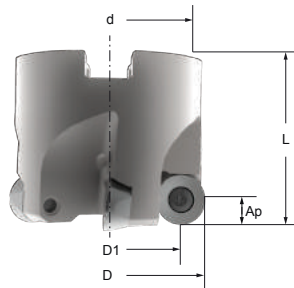

SHELL MILL - RX.. 10T3 M0

DESIGNATION	D	D1	d	L	A_p	Z	α	CATALOG #
LT 101 M-W-D040/5	40	30	16	40	5	5	5.5	M2003442
LT 101 M-W-D050/6	50	40	22	40	5	6	4.0	M2001568
LT 101 M-W-D052/5	52	42	22	40	5	5	4.0	M2001569
LT 101 M-W-D052/6	52	42	22	40	5	6	4.0	M2001570
LT 101 M-W-D063/7	63	53	22	40	5	7	3.0	M2001571
LT 101 M-W-D066/6	66	56	22	40	5	6	2.6	M2001572
LT 101 M-W-D066/7	66	56	22	40	5	7	2.6	M2001573

SCREW M2003786
KEY M2000602

SHELL MILL - RX.. 1204 M0

DESIGNATION	D	D1	d	L	A_p	Z	α	CATALOG #
LT 121 M-W-D040/4	40	28.0	16	40	6	4	7.5	M2001855
LT 121 M-W-D050/5	50	38.0	22	40	6	5	5.0	M2001856
LT 121 M-W-D052/5	52	40.0	22	40	6	5	5.0	M2001857
LT 121 M-W-D063/7	63	51.0	22	40	6	7	3.0	M2001858
LT 121 M-W-D066/6	66	54.0	22	40	6	6	3.0	M2001859
LT 121 M-W-D066/7	66	54.0	22	40	6	7	3.0	M2001860
LT 121 M-W-D080/7	80	68.0	27	50	6	7	2.5	M2001861
LT 121 M-W-D080/9	80	68.0	27	50	6	9	2.5	M2001862

SCREW M2000597
KEY M2000602

MILLING

CUTTERS RX..

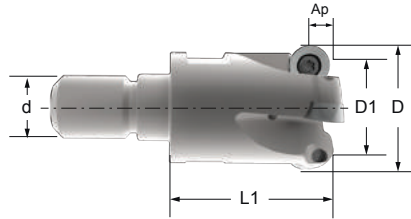

SCREW COUPLING - RX.. 10T3 M0

DESIGNATION	D	D1	d	L1	Ap	Z	α	CATALOG #
LT 101 S-W-D025/3	25	15	M12	35	5	3	10.0	M2001574
LT 101 S-W-D032/3	32	22	M16	35	5	3	8.5	M2001575
LT 101 S-W-D032/4	32	22	M16	35	5	4	8.5	M2001576

SCREW M2003786
KEY M2000602

SCREW COUPLING - RX.. 1204 M0

DESIGNATION	D	D1	d	L1	Ap	Z	α	CATALOG #
LT 121 S-W-D040/4	40	28.0	M16	40	6	4	7.5	M2001863

SCREW M2000597
KEY M2000602

SLOT MILLING

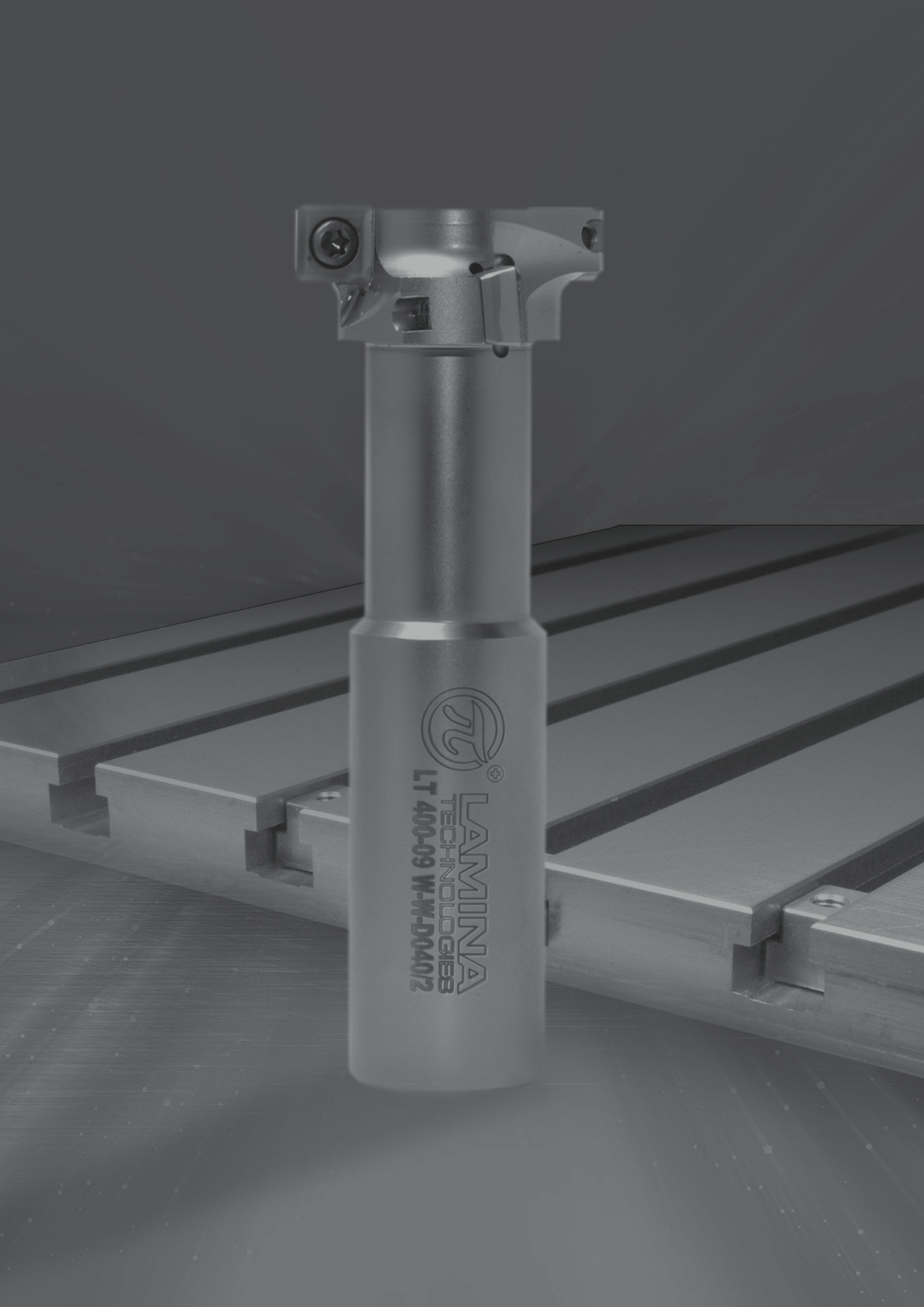



L⁺AMINA
TECHNOLOGIES
LT 400-09 W-W-D04012

T-SLOTTING WITH MULTI-MAT™

High quality cutters for T-slot milling operations combined with our winning Multi-Mat™ grade inserts.

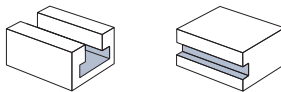
- Reduce costs of cutting tools with our SPMT Multi-Mat™ inserts with four cutting edges per insert
- Approach angle $k = 90^\circ$
- Soft cutting due to the positive geometry
- Internal coolant supply
- For slotting according to DIN 650 norms



S P M T



MAGIA

DESIGNATION	GRADE	RADIUS (mm)	CUTTING EDGES	CUTTER LINE	MATERIAL RECOMMENDATION	CATALOG #
SPMT 060304 TN	LT 3000	0.40	4	LT 400		M0003416
SPMT 09T308 TN	LT 3000	0.80	4	LT 400		M0003417
SPMT 120408 TN	LT 3000	0.80	4	LT 400		M0003419

ALPHA

DESIGNATION	GRADE	RADIUS (mm)	CUTTING EDGES	CUTTER LINE	MATERIAL RECOMMENDATION	CATALOG #
SPMT 060304 TN	LT 30	0.40	4	LT 400		M0003100
SPMT 09T308 TN	LT 30	0.80	4	LT 400		M0003063
SPMT 120408 TN	LT 30	0.80	4	LT 400		M0003105

MATERIAL GROUP

STEEL	HIGH TEMP ALLOYS
STAINLESS STEEL	HARDENED MATERIAL
CAST IRON	ALU(>8%Si)

CUTTING SPEED



DOC / FEED



ORDERING EXAMPLE

QUANTITY	10 PIECES
DESIGNATION + GRADE	CCMT 060204 NN LT 1000
CATALOG NUMBER	T0001888

CUTTERS SPMT - SLOTTING

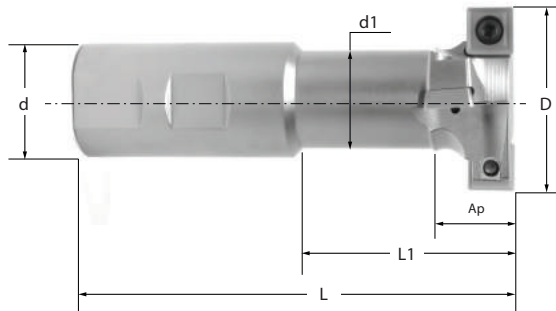

END MILL - SPMT 060304

DESIGNATION	D	d1	d	L	L1	Ap	Z	Z _(EFF)	CATALOG #
LT 400-06 W-W-D021/1	21	11	16	76	26	9	2	1	M2004218
LT 400-06 W-W-D025/2	25	12	16	82	31	11	4	2	M2004219

SCREW M2002181
KEY M2000601

END MILL - SPMT 09T308

DESIGNATION	D	d1	d	L	L1	Ap	Z	Z _(EFF)	CATALOG #
LT 400-09 W-W-D032/2	32	17	20	88	38	14	4	2	M2004220
LT 400-09 W-W-D040/2	40	21	25	108	50	17	4	2	M2004221

SCREW M2001418
KEY M2000602

END MILL - SPMT 120408

DESIGNATION	D	d1	d	L	L1	Ap	Z	Z _(EFF)	CATALOG #
LT 400-12 W-W-D050/2	50	27	32	120	56	22	4	2	M2004222

SCREW M2000599
KEY M2000603

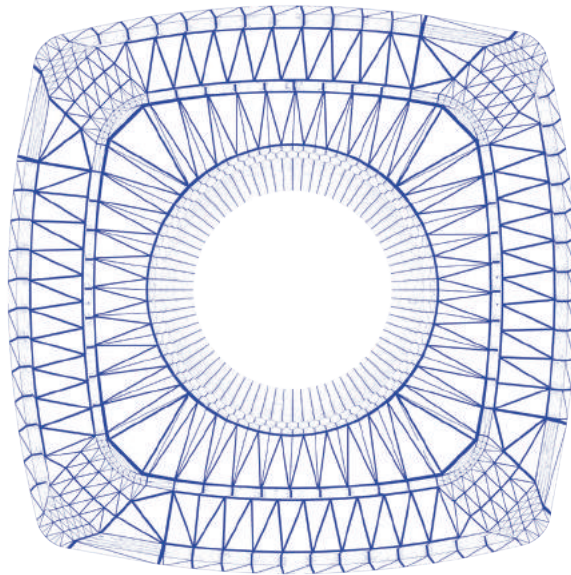

EFFICIENCY



ALU MILLING





LT 05 ALUMINIUM GRADE

Highly positive inserts with a unique coating. Ideal for 90° shoulder milling and 45° face milling of aluminium.

- Dedicated for aluminum and other non-ferrous materials
- Low friction
- High resistance to built up edge
- Extremely long tool life

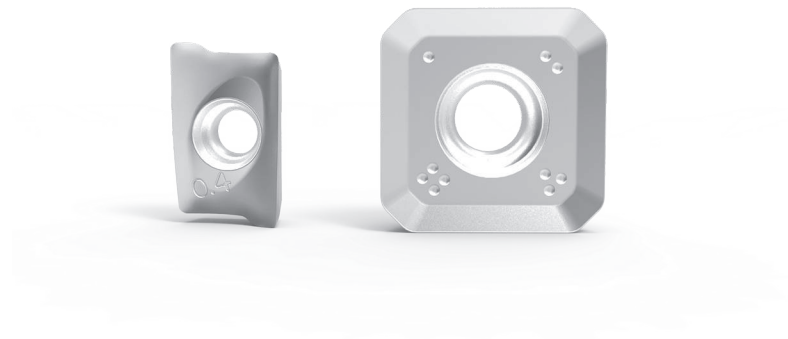

APGT



DESIGNATION	GRADE	RADIUS (mm)	CUTTING EDGES	CUTTER LINE	MATERIAL RECOMMENDATION	CATALOG #
APGT 100304 PDER - ALU	LT 05	0.4	2	LT 741		M0003089
APGT 160408 PDER - ALU	LT 05	0.8	2	LT 731		M0001010

CUTTERS APGT

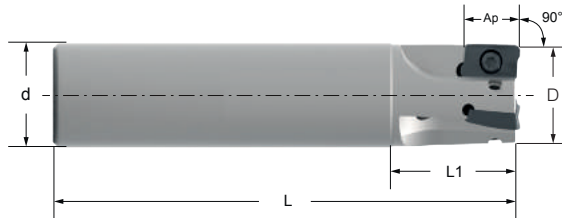

END MILL - APGT 100304 PDER

DESIGNATION	D	d	L	L1	Ap	Z	α	CATALOG #
LT 741 C-W-D016/2	16	16	100	25	9	2	12	M2002806
LT 741 CL-W-D016/2	16	16	150	35	9	2	12	M2002817
LT 741 C-W-D018/2	18	20	100	30	9	2	12	M2002807
LT 741 C-W-D020/3	20	20	100	30	9	3	7	M2002808
LT 741 CL-W-D020/3	20	20	150	35	9	3	7	M2002818
LT 741 C-W-D022/3	22	20	100	30	9	3	7	M2002809
LT 741 C-W-D025/3	25	25	120	30	9	3	5	M2002810
LT 741 CL-W-D025/4	25	25	200	40	9	4	5	M2002819
LT 741 C-W-D025/4	25	25	120	30	9	4	5	M2002811
LT 741 C-W-D028/4	28	25	120	30	9	4	2	M2002812
LT 741 C-W-D030/4	30	25	120	30	9	4	2	M2002813
LT 741 W-W-D032/5	32	32	120	30	9	5	3	M2002814
LT 741 WL-W-D032/4	32	32	200	40	9	4	3	M2002820

SCREW M2002181
KEY M2000601

MATERIAL GROUP

- STEEL
- STAINLESS STEEL
- CAST IRON
- HIGH TEMP ALLOYS
- HARDENED MATERIAL
- ALU(>8%Si)

CUTTING SPEED



DOC / FEED



ORDERING EXAMPLE

QUANTITY 10 PIECES
DESIGNATION + GRADE CCMT 060204 NN LT 1000
CATALOG NUMBER T0001888

CUTTERS APGT

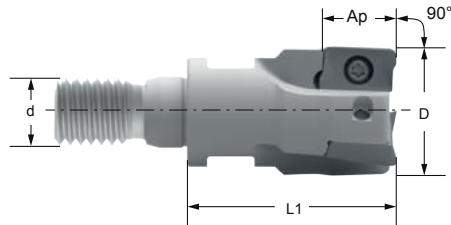

SCREW COUPLING - APGT 100304 PDER

DESIGNATION	D	d	L1	Ap	Z	α	CATALOG #
LT 741 S-W-D016/2	16	M8	25	9	2	10	M2002962
LT 741 S-W-D020/3	20	M10	30	9	3	7	M2002963
LT 741 S-W-D025/4	25	M12	35	9	4	5	M2002964

SCREW KEY M2002181
M2000601

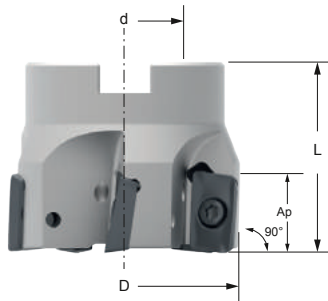

SHELL MILL - APGT 100304 PDER

DESIGNATION	D	d	L	Ap	Z	α	CATALOG #
LT 741 M-W-D040/6	40	16	40	9	6	2.5	M2002798
LT 741 M-W-D050/7	50	22	40	9	7	2.2	M2002799
LT 741 M-W-D063/8	63	22	40	9	8	1.8	M2002800
LT 741 M-W-D080/11*	80	27	50	9	11	1.4	M2002801

*On Request

SCREW KEY M2002181
M2000601

ALU MILLING

CUTTERS APGT

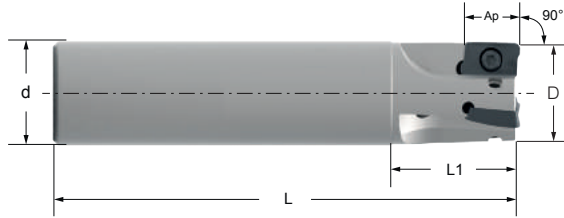

END MILL - APGT 1604

DESIGNATION	D	d	L	L1	Ap	Z	α	CATALOG #
LT 731 W-W-D025/2	25	25	100	44	15	2	5	M2002966
LT 731 WL-W-D025/2	25	25	220	90	15	2	5	M2002965
LT 731 W-W-D032/3	32	32	110	50	15	3	3	M2002968
LT 731 WL-W-D032/3	32	32	220	90	15	3	3	M2002967
LT 731 W-W-D040/4	40	32	115	50	15	4	2.5	M2002970
LT 731 WL-W-D040/4	40	32	220	90	15	4	2.5	M2002969

SCREW M2000597
KEY M2000602

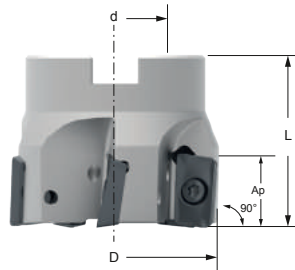

SHELL MILL - APGT 160408 PDTR

DESIGNATION	D	d	L	Ap	Z	α	CATALOG #
LT 731 M-W-D040/4	40	16	40	15	4	2.5	M2002971
LT 731 M-W-D050/5	50	22	40	15	5	2.2	M2002972
LT 731 M-W-D063/6	63	22	40	15	6	1.8	M2002973
LT 731 M-W-D080/7	80	27	50	15	7	1.4	M2002974
LT 731 M-W-D100/8	100	32	50	15	8	1.1	M2002975
LT 731 M-W-D125/9	125	40	63	15	9	0.8	M2002976
LT 731 M-D-D160/10*	160	40	63	15	10	N/A	M2002977

*On Request

SCREW M2000597
KEY M2000602

SEGT



DESIGNATION	GRADE	RADIUS (mm)	CUTTING EDGES	CUTTER LINE	MATERIAL RECOMMENDATION	CATALOG #
SEGT 1204 AFEN - ALU	LT 05	0.84	4	LT 600		M0001008

CUTTERS SEGT

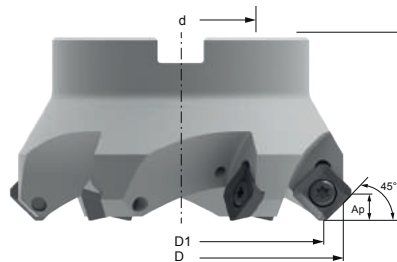

SHELL MILL - SEGT 1204 AFEN-ALU

DESIGNATION	D	D1	d	L	Ap	Z	α	CATALOG #
LT 600 M-W-D040/3	53	40	16	40	6	3	10	M2000546
LT 600 M-W-D050/4	63	50	22	48	6	4	8	M2000547
LT 600 M-W-D063/5	76	63	22	48	6	5	6	M2000548
LT 600 M-W-D080/6	93	80	27	50	6	6	4.5	M2000549
LT 600 M-W-D100/6	113	100	32	50	6	6	3.5	M2000550
LT 600 M-W-D125/7	138	125	40	63	6	7	3	M2000551
LT 600 M-D-D160/8	173	160	40	63	6	8	2.2	M2000552

SCREW M2000599
KEY M2000603

MATERIAL GROUP

STEEL	HIGH TEMP ALLOYS
STAINLESS STEEL	HARDENED MATERIAL
CAST IRON	ALU(>8%Si)

CUTTING SPEED



DOC / FEED



ORDERING EXAMPLE

QUANTITY	10 PIECES
DESIGNATION + GRADE	CCMT 060204 NN LT 1000
CATALOG NUMBER	T0001888

Multi-Mat™
... and life becomes easy



SOLID CARBIDE END MILLS



- 
- Next generation Multi-Mat™ Solid End Mills
 - Increased toughness for extended application range
 - Longer tool life through new and unique coating composition.
 - New and exclusive ultra fine grained coating
 - Exclusive edge preparation and pre-coating surface treatment
 - Unique substrate
-

MAGIA

LT 4000 PREMIUM MULTI-MAT™ GRADE FOR SOLID CARBIDE END MILLS

Magia LT 4000 is the latest, state-of-the-art PVD grade using high density plasma to create nano-structured PVD coatings with incredible properties.

With this new PVD technology in combination with our exclusive substrate and edge preparation, Magia Solid Carbide delivers increased toughness for the most extreme applications, higher reliability in lower cutting speeds with coolant which results in an extended application range.

Increased tool life due to reduced friction between the coating and the chips, and a harder coating composite that better resists abrasion.

We have achieved unprecedented tool life.



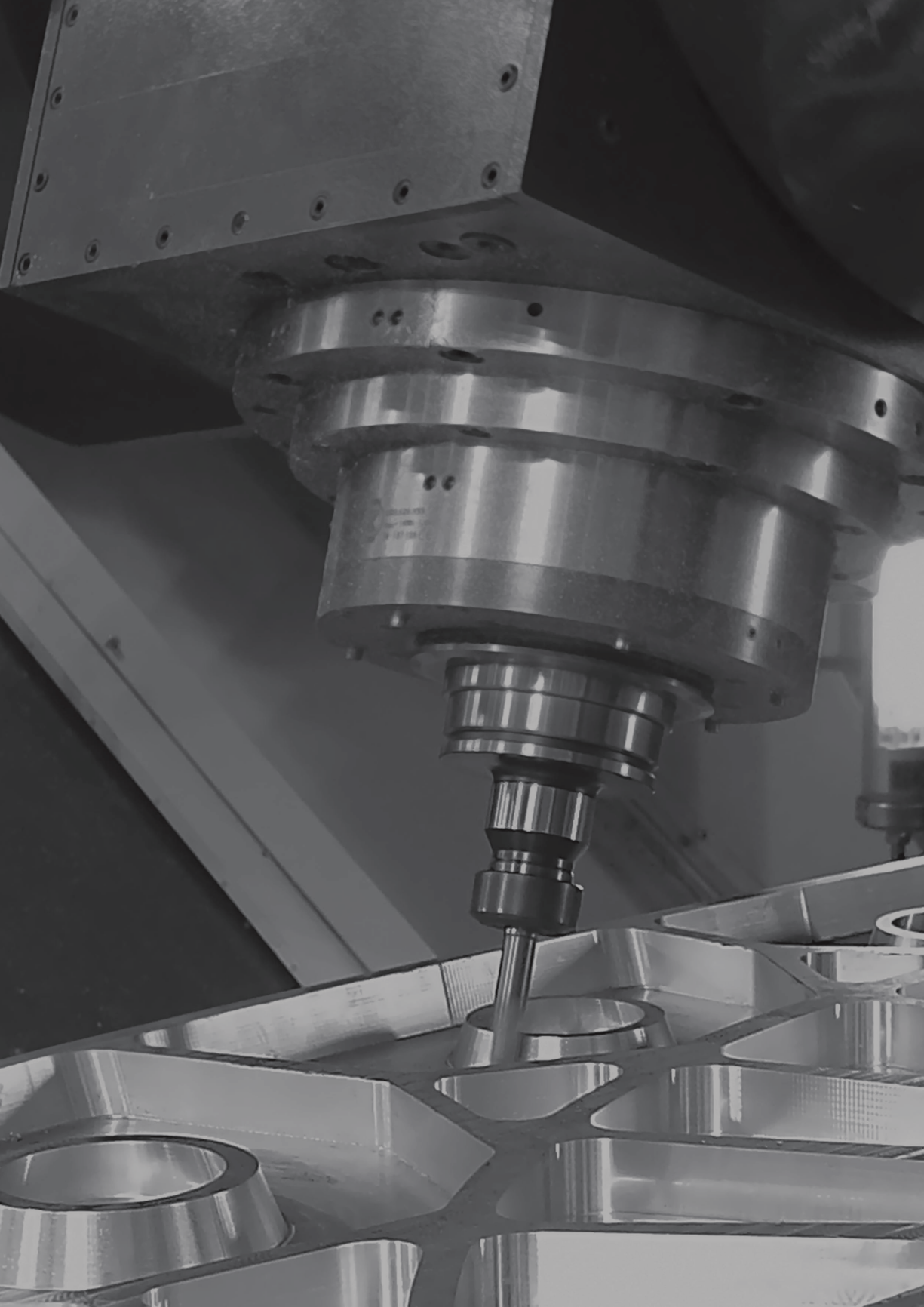

ALPHA

LT 40 EXCELLENT PERFORMANCE AT AN AFFORDABLE PRICE

Our general purpose Alpha line provide value and versatility at an attractive price. Alpha Line is our standard, general usage product line. Our Alpha LT 40 grade for solid carbide end mills is designed to work in a wide variety of applications and workpiece materials. It is ideal for customers with pricing considerations while also expecting high level performance.



90° Z2

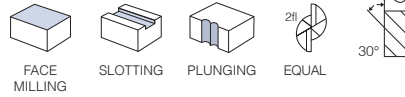
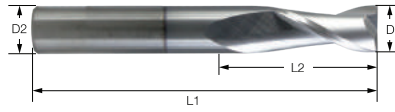

MAGIA

90° 2 FLUTE

DESIGNATION	GRADE	D1	D2	L1	L2	CATALOG #
E90 Z2 D00.2(03) L0.5(038)	LT 4000	0.2	3	38	0.5	M5003531
E90 Z2 D00.3(03) L0.8(038)	LT 4000	0.3	3	38	0.8	M5003532
E90 Z2 D00.4(03) L1.0(038)	LT 4000	0.4	3	38	1.0	M5003533
E90 Z2 D00.5(03) L1.2(038)	LT 4000	0.5	3	38	1.2	M5003534
E90 Z2 D00.6(03) L1.5(038)	LT 4000	0.6	3	38	1.5	M5003535
E90 Z2 D00.8(03) L2.0(038)	LT 4000	0.8	3	38	2	M5003536
E90 Z2 D01.0(03) L3.0(038)	LT 4000	1.0	3	38	3	M5003520
E90 Z2 D01.5(03) L5.0(038)	LT 4000	1.5	3	38	5	M5003537
E90 Z2 D02.0(03) L6.0(038)	LT 4000	2.0	3	38	6	M5003538
E90 Z2 D02.5(03) L7.0(038)	LT 4000	2.5	3	38	7	M5003539
E90 Z2 D03.0(03) L9.0(038)	LT 4000	3.0	3	38	9	M5003540
E90 Z2 D04.0(04) L14.0(050)	LT 4000	4.0	4	50	14	M5003541
E90 Z2 D05.0(05) L16.0(050)	LT 4000	5.0	5	50	16	M5003542
E90 Z2 D06.0(06) L20.0(063)	LT 4000	6.0	6	63	20	M5003543
E90 Z2 D08.0(08) L20.0(063)	LT 4000	8.0	8	63	20	M5003544
E90 Z2 D10.0(10) L22.0(072)	LT 4000	10.0	10	72	22	M5003545
E90 Z2 D12.0(12) L26.0(075)	LT 4000	12.0	12	75	26	M5003546

CUTTING SPEED



p. 290

DOC / FEED



p. 291 - 302

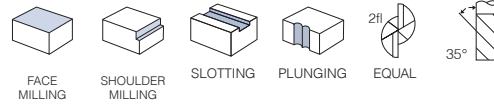

ALPHA

90° 2 FLUTE

DESIGNATION	GRADE	D1	D2	L1	L2	CATALOG #
E90 Z2 D01.0(04) L03.0(050)	LT 40	1	4	50	3	M5005500
E90 Z2 D01.5(04) L05.0(050)	LT 40	1.5	4	50	5	M5005501
E90 Z2 D02.0(04) L05.0(050)	LT 40	2	4	50	5	M5005502
E90 Z2 D02.5(04) L08.0(050)	LT 40	2.5	4	50	8	M5005503
E90 Z2 D03.0(04) L08.0(050)	LT 40	3	4	50	8	M5005504
E90 Z2 D04.0(04) L11.0(050)	LT 40	4	4	50	11	M5005505
E90 Z2 D05.0(06) L13.0(050)	LT 40	5	6	50	13	M5005506
E90 Z2 D06.0(06) L16.0(050)	LT 40	6	6	50	16	M5005507
E90 Z2 D08.0(08) L20.0(060)	LT 40	8	8	60	20	M5005508
E90 Z2 D10.0(10) L25.0(072)	LT 40	10	10	72	25	M5005509
E90 Z2 D12.0(12) L30.0(075)	LT 40	12	12	75	30	M5005510
E90 Z2 D16.0(16) L40.0(100)	LT 40	16	16	100	40	M5005511

90° Z3

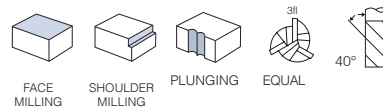
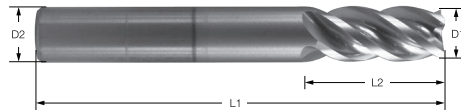

MAGIA

90° 3 FLUTE

DESIGNATION	GRADES	D1	D2	L1	L2	CATALOG #
E90 Z3 D03.0(06) L8.0(050)	LT 4000	3.0	6	50	8	M5003548
E90 Z3 D04.0(06) L11.0(050)	LT 4000	4.0	6	50	11	M5003549
E90 Z3 D05.0(06) L13.0(050)	LT 4000	5.0	6	50	13	M5003550
E90 Z3 D06.0(06) L16.0(050)	LT 4000	6.0	6	50	16	M5003551
E90 Z3 D08.0(08) L20.0(060)	LT 4000	8.0	8	60	20	M5003552
E90 Z3 D10.0(10) L25.0(072)	LT 4000	10.0	10	72	25	M5003553
E90 Z3 D12.0(12) L30.0(075)	LT 4000	12.0	12	75	30	M5003554

CUTTING SPEED



p. 290

DOC / FEED



p. 291 - 302

90° Z4

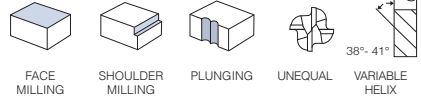
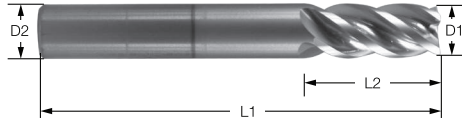

MAGIA

90° 4 FLUTE

DESIGNATION	GRADE	D1	D2	L1	L2	CATALOG #
E90 Z4 D01.0(04) L03.0(050)	LT 4000	1.0	4	50	3	M5003568
E90 Z4 D01.5(04) L05.0(050)	LT 4000	1.5	4	50	5	M5003569
E90 Z4 D02.0(04) L06.0(050)	LT 4000	1.5	4	50	6	M5003570
E90 Z4 D02.5(04) L08.0(050)	LT 4000	2.0	4	50	8	M5003571
E90 Z4 D03.0(06) L08.0(050)	LT 4000	3.0	6	50	8	M5003572
E90 Z4 D04.0(06) L11.0(050)	LT 4000	4.0	6	50	11	M5003573
E90 Z4 D05.0(06) L13.0(050)	LT 4000	5.0	6	50	13	M5003574
E90 Z4 D06.0(06) L16.0(050)	LT 4000	6.0	6	50	16	M5003575
E90 Z4 D08.0(08) L20.0(060)	LT 4000	8.0	8	60	20	M5003576
E90 Z4 D10.0(10) L22.0(072)	LT 4000	10.0	10	72	22	M5003577
E90 Z4 D12.0(12) L26.0(075)	LT 4000	12.0	12	75	26	M5003578
E90 Z4 D16.0(16) L38.0(100)	LT 4000	16.0	16	100	38	M5003579

CUTTING SPEED



p. 290

DOC / FEED



p. 291 - 302

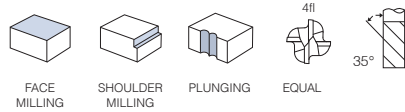

ALPHA

90° 4 FLUTE, SHORT

DESIGNATION	GRADE	D1	D2	L1	L2	CATALOG #
E90 Z4 D01.0(04) L03.0(050)	LT 40	1	4	50	3	M5005512
E90 Z4 D01.5(04) L05.0(050)	LT 40	1.5	4	50	5	M5005513
E90 Z4 D02.0(04) L06.0(050)	LT 40	2	4	50	6	M5005514
E90 Z4 D02.5(04) L08.0(050)	LT 40	2.5	4	50	8	M5005515
E90 Z4 D03.0(04) L08.0(050)	LT 40	3	4	50	8	M5005516
E90 Z4 D04.0(04) L11.0(050)	LT 40	4	4	50	11	M5005517
E90 Z4 D05.0(06) L13.0(050)	LT 40	5	6	50	13	M5005518
E90 Z4 D06.0(06) L16.0(050)	LT 40	6	6	50	16	M5005519
E90 Z4 D08.0(08) L20.0(060)	LT 40	8	8	60	20	M5005520
E90 Z4 D10.0(10) L25.0(072)	LT 40	10	10	72	25	M5005521
E90 Z4 D12.0(12) L30.0(075)	LT 40	12	12	75	30	M5005522
E90 Z4 D16.0(16) L40.0(100)	LT 40	16	16	100	40	M5005523

CUTTING SPEED



p. 290

DOC / FEED



p. 291 - 302

90° Z4 L

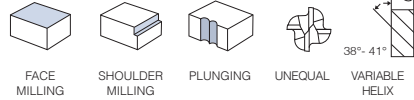
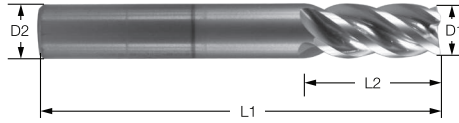

MAGIA

90° 4 FLUTE, LONG

DESIGNATION	GRADE	D1	D2	L1	L2	CATALOG #
E90 Z4 D03.0(06) L12.0(050)	LT 4000	3.0	6	50	12	M5003559
E90 Z4 D04.0(06) L16.0(055)	LT 4000	4.0	6	55	16	M5003560
E90 Z4 D05.0(06) L20.0(060)	LT 4000	5.0	6	60	20	M5003561
E90 Z4 D06.0(06) L24.0(065)	LT 4000	6.0	6	65	24	M5003562
E90 Z4 D08.0(08) L32.0(090)	LT 4000	8.0	8	90	32	M5003563
E90 Z4 D10.0(10) L40.0(100)	LT 4000	10.0	10	100	40	M5003564
E90 Z4 D12.0(12) L48.0(110)	LT 4000	12.0	12	110	48	M5003565
E90 Z4 D16.0(16) L64.0(160)	LT 4000	16.0	16	160	64	M5003566

CUTTING SPEED



p. 290

DOC / FEED



p. 291 - 302

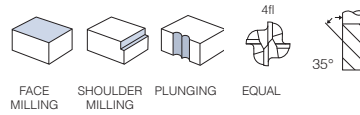

ALPHA

90° 4 FLUTE, LONG

DESIGNATION	GRADE	D1	D2	L1	L2	CATALOG #
E90 Z4 D03.0(06) L12.0(070)	LT 40	3	6	70	12	M5005524
E90 Z4 D04.0(06) L15.0(070)	LT 40	4	6	70	15	M5005525
E90 Z4 D05.0(06) L20.0(080)	LT 40	5	6	80	20	M5005526
E90 Z4 D06.0(06) L20.0(080)	LT 40	6	6	80	20	M5005527
E90 Z4 D08.0(08) L25.0(100)	LT 40	8	8	100	25	M5005528
E90 Z4 D10.0(10) L30.0(100)	LT 40	10	10	100	30	M5005529
E90 Z4 D12.0(12) L40.0(110)	LT 40	12	12	110	40	M5005530
E90 Z4 D16.0(16) L50.0(140)	LT 40	16	16	140	50	M5005531

CUTTING SPEED



p. 290

DOC / FEED



p. 291 - 302

90° Z4 R

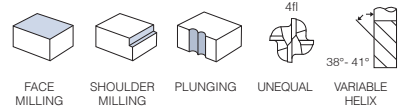
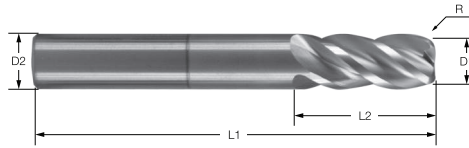

MAGIA

90° 4 FLUTE WITH RADIUS

DESIGNATION	GRADE	D1	D2	L1	L2	R	CATALOG #
E90 Z4 D03.0(06) L08.0(050) R0.5	LT 4000	3	6	50	8	0.5	M5003614
E90 Z4 D04.0(06) L11.0(050) R0.5	LT 4000	4	6	50	11	0.5	M5003615
E90 Z4 D05.0(06) L13.0(050) R0.5	LT 4000	5	6	50	13	0.5	M5003616
E90 Z4 D06.0(06) L16.0(050) R0.5	LT 4000	6	6	50	16	0.5	M5003617
E90 Z4 D08.0(08) L20.0(060) R0.5	LT 4000	8	8	60	20	0.5	M5003618
E90 Z4 D10.0(10) L22.0(072) R0.5	LT 4000	10	10	72	22	0.5	M5003619
E90 Z4 D12.0(12) L26.0(075) R0.5	LT 4000	12	12	75	26	0.5	M5003620
E90 Z4 D03.0(06) L08.0(050) R1.0	LT 4000	3	6	50	8	1.0	M5003623
E90 Z4 D04.0(06) L11.0(050) R1.0	LT 4000	4	6	50	11	1.0	M5003624
E90 Z4 D05.0(06) L13.0(050) R1.0	LT 4000	5	6	50	13	1.0	M5003625
E90 Z4 D06.0(06) L16.0(050) R1.0	LT 4000	6	6	50	16	1.0	M5003626
E90 Z4 D08.0(08) L20.0(060) R1.0	LT 4000	8	8	60	20	1.0	M5003627
E90 Z4 D10.0(10) L22.0(072) R1.0	LT 4000	10	10	72	22	1.0	M5003628
E90 Z4 D12.0(12) L26.0(075) R1.0	LT 4000	12	12	75	26	1.0	M5003629
E90 Z4 D06.0(06) L16.0(050) R2.0	LT 4000	6	6	50	16	2.0	M5003632
E90 Z4 D08.0(08) L20.0(060) R2.0	LT 4000	8	8	60	20	2.0	M5003633
E90 Z4 D10.0(10) L22.0(072) R2.0	LT 4000	10	10	72	22	2.0	M5003634
E90 Z4 D12.0(12) L26.0(075) R2.0	LT 4000	12	12	75	26	2.0	M5003635

CUTTING SPEED



p. 290

DOC / FEED



p. 291 - 302

90° Z4 RL

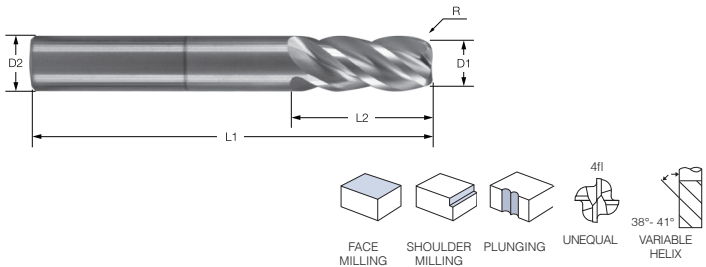

MAGIA

90° 4 FLUTE WITH RADIUS, LONG

DESIGNATION	GRADE	D1	D2	L1	L2	R	CATALOG #
E90 Z4 D08.0(08) L32.0(090) R0.5	LT 4000	8	8	90	32	0.5	M5003638
E90 Z4 D10.0(10) L40.0(100) R0.5	LT 4000	10	10	100	40	0.5	M5003639
E90 Z4 D12.0(12) L48.0(110) R0.5	LT 4000	12	12	110	48	0.5	M5003640

CUTTING SPEED



p. 290

DOC / FEED



p. 291 - 302

EBN

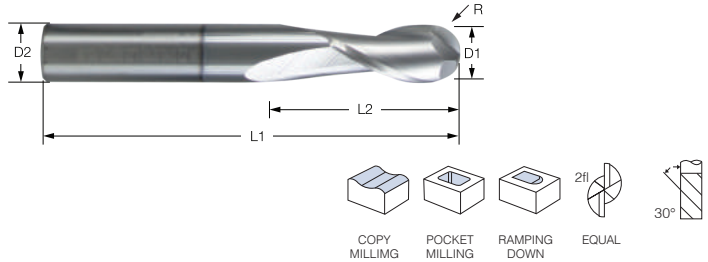

MAGIA

BALL NOSE, 2 FLUTE

DESIGNATION	GRADE	D1	D2	L1	L2	R	CATALOG #
EBN Z2 D01.0(03) L03.0(038) R0.50	LT 4000	1	3	38	3	0.50	M5003587
EBN Z2 D01.5(03) L05.0(038) R0.75	LT 4000	1.5	3	38	5	0.75	M5003588
EBN Z2 D02.0(03) L06.0(038) R1.00	LT 4000	2	3	38	6	1	M5003589
EBN Z2 D02.5(03) L07.0(038) R1.25	LT 4000	2.5	3	38	7	1.25	M5003590
EBN Z2 D03.0(03) L09.0(038) R1.50	LT 4000	3	3	38	9	1.5	M5003591
EBN Z2 D04.0(04) L14.0(050) R2.00	LT 4000	4	4	50	14	2	M5003592
EBN Z2 D05.0(05) L16.0(050) R2.50	LT 4000	5	5	50	16	2.5	M5003593
EBN Z2 D06.0(06) L20.0(063) R3.00	LT 4000	6	6	63	20	3	M5003594
EBN Z2 D08.0(08) L20.0(063) R4.00	LT 4000	8	8	63	20	4	M5003595
EBN Z2 D10.0(10) L22.0(072) R5.00	LT 4000	10	10	72	22	5	M5003596
EBN Z2 D12.0(12) L26.0(075) R6.00	LT 4000	12	12	75	26	6	M5003597

CUTTING SPEED



p. 290

DOC / FEED



p. 291 - 302

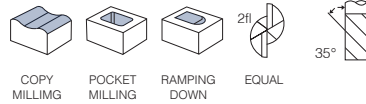

ALPHA

BALL NOSE, 2 FLUTE

DESIGNATION	GRADE	D1	D2	L1	L2	R	CATALOG #
EBN Z2 D01.0(04) L02.0(050)	LT 40	1	4	50	2	0.5	M5005532
EBN Z2 D01.5(04) L03.0(050)	LT 40	1.5	4	50	3	0.75	M5005533
EBN Z2 D02.0(04) L04.0(050)	LT 40	2	4	50	4	1	M5005534
EBN Z2 D02.5(04) L05.0(050)	LT 40	2.5	4	50	5	1.25	M5005535
EBN Z2 D03.0(04) L06.0(050)	LT 40	3	4	50	6	1.5	M5005536
EBN Z2 D04.0(04) L08.0(050)	LT 40	4	4	50	8	2	M5005537
EBN Z2 D05.0(06) L10.0(050)	LT 40	5	6	50	10	2.5	M5005538
EBN Z2 D06.0(06) L12.0(050)	LT 40	6	6	50	12	3	M5005539
EBN Z2 D08.0(08) L14.0(060)	LT 40	8	8	60	14	4	M5005540
EBN Z2 D10.0(10) L18.0(072)	LT 40	10	10	72	18	5	M5005541
EBN Z2 D12.0(12) L22.0(075)	LT 40	12	12	75	22	6	M5005542
EBN Z2 D16.0(16) L30.0(100)	LT 40	16	16	100	30	8	M5005543

CUTTING SPEED



p. 290

DOC / FEED



p. 291 - 302

ERO Z3

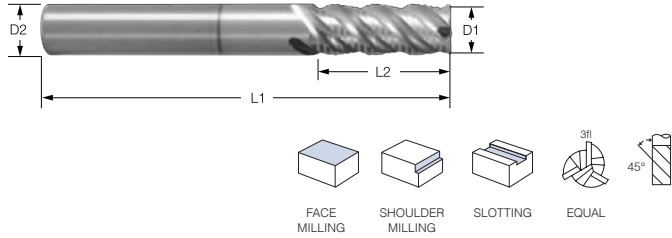

MAGIA

ROUGHER, 3 FLUTE

DESIGNATION	GRADE	D1	D2	L1	L2	CATALOG #
ERO Z3 D04.0(06) L11.0(057)	LT 4000	4	6	57	11	M5003607

ERO Z4

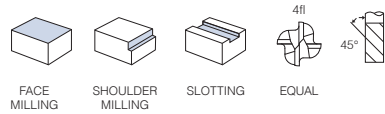

MAGIA

ROUGHER, 4 FLUTE

DESIGNATION	GRADE	D1	D2	L1	L2	CATALOG #
ERO Z4 D05.0(06) L13.0(057)	LT 4000	5	6	57	13	M5003608
ERO Z4 D06.0(06) L13.0(057)	LT 4000	6	6	57	13	M5003609
ERO Z4 D08.0(08) L19.0(063)	LT 4000	8	8	63	19	M5003610
ERO Z4 D10.0(10) L22.0(072)	LT 4000	10	10	72	22	M5003611
ERO Z4 D12.0(12) L26.0(083)	LT 4000	12	12	83	26	M5003612

EHF Z4

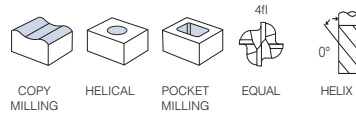
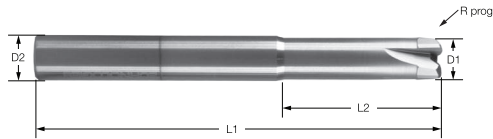
MAGIA
HIGH FEED, 4 FLUTE

DESIGNATION	GRADE	D1	D2	L1	L2	CATALOG #
EHF Z4 D03.0(06) L02.0(070) R0.37	LT 4000	3	6	70	12	M5003600
EHF Z4 D04.0(06) L02.0(070) R0.47	LT 4000	4	6	70	16	M5003601
EHF Z4 D05.0(06) L02.5(070) R0.60	LT 4000	5	6	70	20	M5003602
EHF Z4 D06.0(06) L03.0(070) R0.73	LT 4000	6	6	70	25	M5003603
EHF Z4 D08.0(08) L04.0(080) R0.98	LT 4000	8	8	80	30	M5003604
EHF Z4 D10.0(10) L05.0(090) R1.23	LT 4000	10	10	90	35	M5003605
EHF Z4 D12.0(12) L06.0(100) R1.65	LT 4000	12	12	100	40	M5003606

CUTTING SPEED



p. 290

DOC / FEED



p. 291 - 302

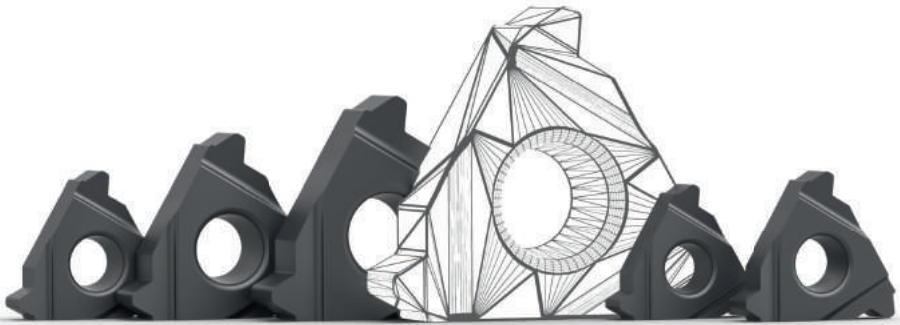

MADE IN SWITZERLAND



THREAD MILLING



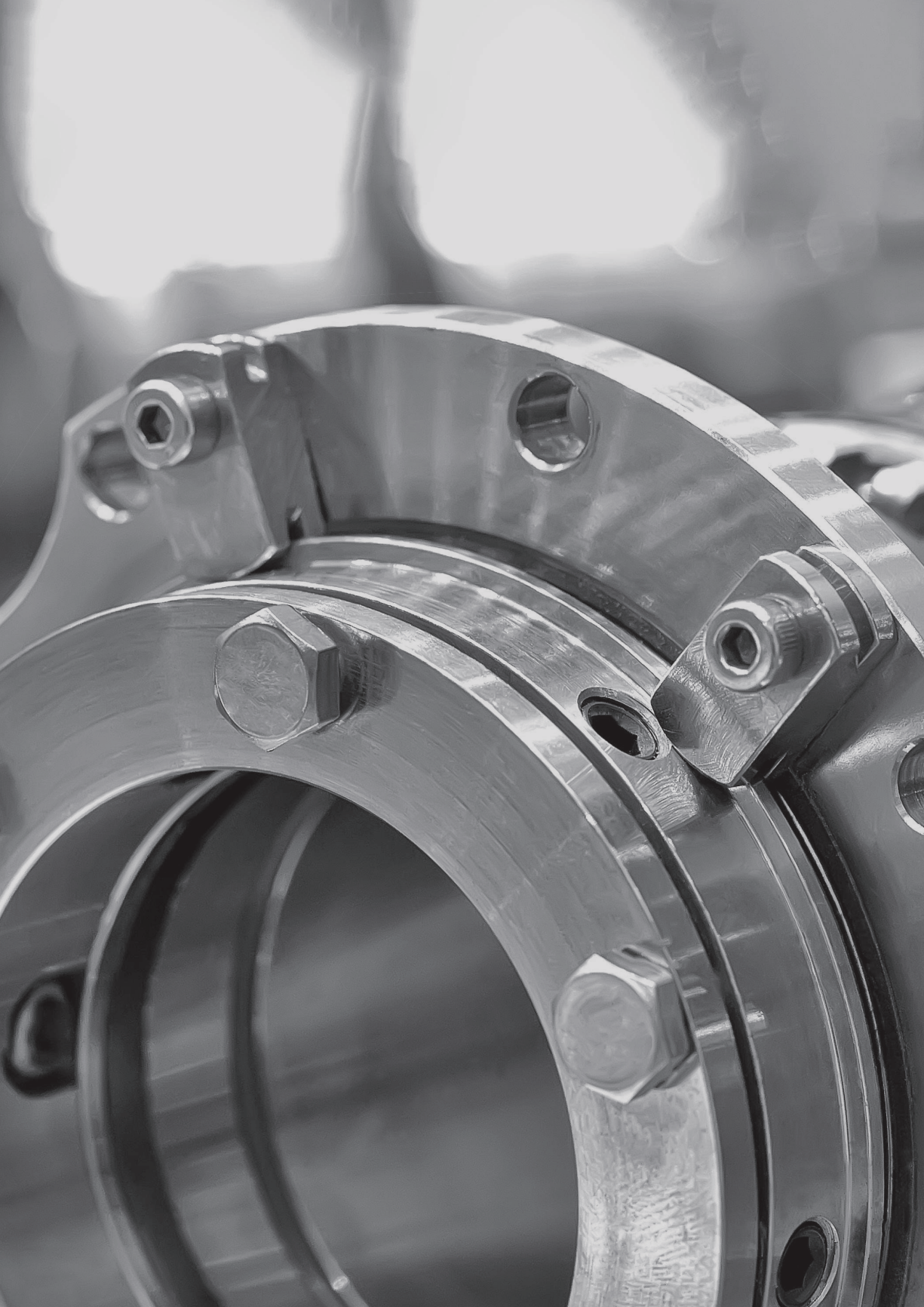

THREAD MILLING

Thread milling is the recommended method anytime producing threads involves variation of dimensions, difficult materials, weak set-ups, slim walls, tap breakage risks, expensive components, tiny tolerances, good surface finishing, long overhangs, right or left hand threads and eventual other obstacles.

ADVANTAGES OF THREAD MILLING

- Continuous spindle rotation – no need to stop and reverse the spindle when coming out of the hole
- Less spindle maintenance and no need of expensive synchronized tap holders
- Easy machining of difficult materials that produces short and controllable chips and much less cutting forces
- Full bottom threading with precise thread depth control and start position
- Less cutting pressure for thin-walled workpieces - less breakage and deformation risks
- One tool for a variety of thread diameters with the same thread pitch
- One tool for both right and left-hand threads as well as through or blind holes
- Minimized tool inventory, less tooling costs



ISO

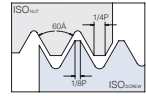

ISO 965-1:1999-11
DIN 13 : 2005-08



ISO METRIC - INTERNAL MINIATURE TOOL

DESIGNATION	THREAD SIZE	PITCH mm	L	L1	D1	D2	Z	CATALOG #
TMC03012L5 0.35 ISO	M1.6X0.35	0.35	39	5.1	3	1.20	3	TH400001
TMC06015L6 0.4 ISO	M2.0X0.40	0.40	39	6.1	3	1.54	3	TH400019
TMC06019L7 0.45 ISO	M2.5X0.45	0.45	39	7.6	4	1.96	3	TH400016
TMC06024L9 0.5 ISO	M3.0X0.50	0.50	51	9.3	4	2.40	3	TH400013
TMC06031L12 0.7 ISO	M4.0X0.70	0.70	51	12.4	6	3.15	3	TH400004
TMC06040L15 0.8 ISO	M5.0X0.80	0.80	57	15.6	6	4.00	3	TH400010
TMC06047L19 1.0 ISO	M6.0X1.00	1.00	57	19.0	6	4.75	3	TH400007
TMC06059L24 1.25 ISO	M8.0X1.25	1.25	57	24.3	6	5.95	3	TH400022
TMC08079L31 1.5 ISO	M10X1.50	1.50	63	31.0	8	7.90	3	TH400025

CUTTING DATA



p. 307 - 308

UN

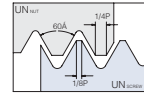

ANSI B1.1-1982



UN - INTERNAL MINIATURE TOOL

DESIGNATION	THREAD SIZE		TPI	L	L1	D1	D2	Z	CATALOG #
	UNC	UNF							
TMC03011L3 80 UN	-	0-80UNF	80	39	3.9	3	1.18	3	TH400052
TMC03014L5 72 UN	-	1-72UNF	72	39	5.8	3	1.44	3	TH400040
TMC03016L6 56 UN	2-56UNC	3-56UNF	56	39	6.8	3	1.66	3	TH400034
TMC06021L8 40 UN	4-40UNC	-	40	51	8.1	6	2.12	3	TH400028
TMC06024L9 40 UN	5-40UNC	6-40UNF	40	51	9.8	6	2.46	3	TH400055
TMC06025L10 32 UN	6-32UNC	-	32	51	10.7	6	2.57	3	TH400031
TMC06032L12 32 UN	8-32UNC	10-32UNF	32	57	12.7	6	3.22	3	TH400037
TMC06048L19 20 UN	1/4-20UNC	7/16-20UNF	20	57	19.4	6	4.85	3	TH400046
TMC06052L19 28 UN	-	1/4-28UNF	28	57	19.3	6	5.20	3	TH400043
TMC08066L24 24 UN	-	5/16-24UNF	24	63	24.2	8	6.65	3	TH400049

CUTTING DATA



p.307 - 308

**We keep your machine
with the green light on**



DRILLING

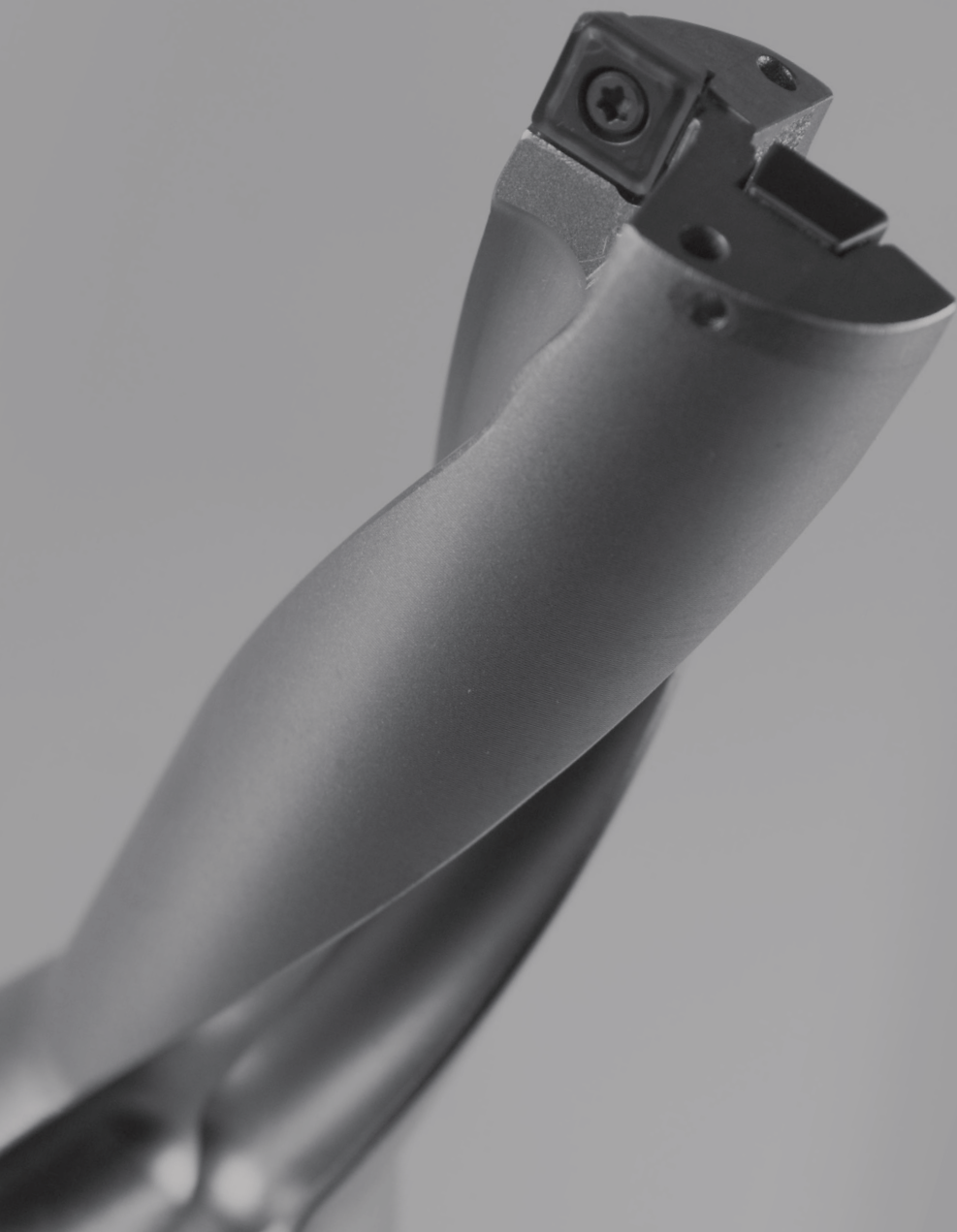



INDEXABLE DRILLING

Multi-Mat™ indexable drilling solutions for general drilling in a variety of materials.

SPMG Multi-Mat™ drilling inserts are designed with optimized grade and geometry for high performance in steel, stainless steel, cast iron and hardened metals. They are also suitable for super alloys and aluminum.

MULTI-MAT™ SPMG DRILLING INSERTS



Same insert for both inner and outer pocket

Multi-Mat™ grade and geometry provide more versatility and reduced stock of unused inserts.

4 cutting edges

FULL RANGE OF 2x, 3x, & 4x D DRILL BODIES

Diameter range
Ø12.5 - Ø41

Available
in drill depths of 2xD,
3xD, 4xD

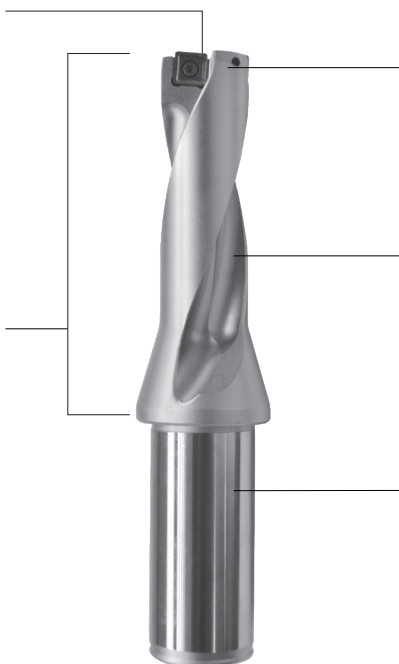

Hardened protection
against chip abrasion
extends tool life

Wide helical chip flute for
effective chip evacuation

Through coolant for
improved tool life
and smoother chip
evacuation

SPMG



DESIGNATION	GRADE	MATERIAL RECOMMENDATION	L	S	R	DIRECTION	CATALOG #
SPMG 050204 NN	LT 30		5.0	2.38	0.40	NEUTRAL	M3003882
SPMG 060204 NN	LT 30		6.0	2.38	0.40	NEUTRAL	M3002913
SPMG 07T308 NN	LT 30		7.94	3.97	0.80	NEUTRAL	M3002914
SPMG 090408 NN	LT 30		9.80	4.30	0.80	NEUTRAL	M3002915
SPMG 110408 NN	LT 30		11.50	4.80	0.80	NEUTRAL	M3003883

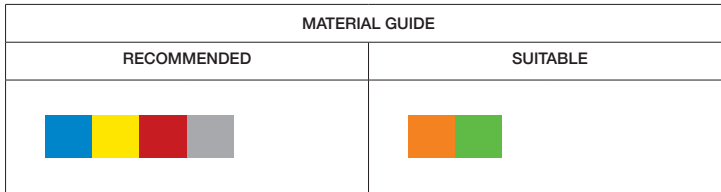
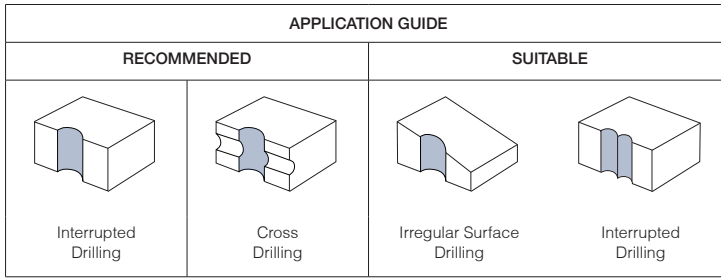

MATERIAL GROUP

STEEL	HIGH TEMP ALLOYS
STAINLESS STEEL	HARDENED MATERIAL
CAST IRON	ALU(>8%Si)

CUTTING SPEED

p. 310

DOC / FEED

p. 311 - 312

2 X D DRILL BODIES - SPMG

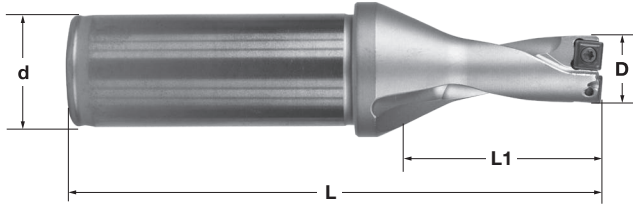

2XD DRILL BODIES - SPMG 050204

DESIGNATION	D1	D2	L1	L2	CATALOG #
LT DR125 S05-2D	12.5	20	94	26	M2003704
LT DR130 S05-2D	13.0	20	94	26	M2003705
LT DR135 S05-2D	13.5	20	96	28	M2003706
LT DR140 S05-2D	14.0	20	96	28	M2003707
LT DR145 S05-2D	14.5	20	99	30	M2003708
LT DR150 S05-2D	15.0	20	99	30	M2003709

2XD DRILL BODIES - SPMG 060204

DESIGNATION	D1	D2	L1	L2	CATALOG #
LT DR160 S06-2D	16.0	25	108	32	M2003247
LT DR170 S06-2D	17.0	25	110	34	M2003248
LT DR175 S06-2D	17.5	25	113	36	M2003695
LT DR180 S06-2D	18.0	25	113	36	M2003249
LT DR185 S06-2D	18.5	25	115	38	M2003696
LT DR190 S06-2D	19.0	25	115	38	M2003250
LT DR200 S06-2D	20.0	25	119	40	M2003251
LT DR210 S06-2D	21.0	25	121	42	M2003252

DRILLING

2 X D DRILL BODIES - SPMG

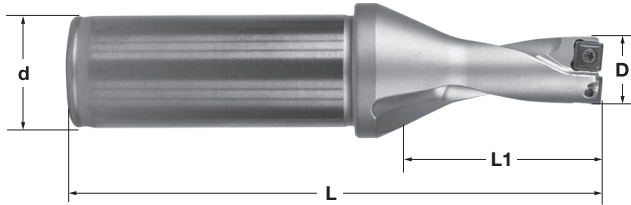

2XD DRILL BODIES - SPMG 07T308

DESIGNATION	D1	D2	L1	L2	CATALOG #
LT DR220 S07-2D	22.0	25	123	44	M2003253
LT DR230 S07-2D	23.0	32	131	46	M2003255
LT DR240 S07-2D	24.0	32	134	48	M2003256
LT DR250 S07-2D	25.0	32	137	50	M2003257
LT DR260 S07-2D	26.0	32	139	52	M2003258
LT DR265 S07-2D	26.5	32	141	54	M2003698
LT DR270 S07-2D	27.0	32	141	54	M2003259

2XD DRILL BODIES - SPMG 090408

DESIGNATION	D1	D2	L1	L2	CATALOG #
LT DR280 S09-2D	28.0	32	144	56	M2003260
LT DR290 S09-2D	29.0	32	146	58	M2003261
LT DR295 S09-2D	29.5	32	151	60	M2003699
LT DR300 S09-2D	30.0	32	151	60	M2003262
LT DR310 S09-2D	31.0	32	154	62	M2003263
LT DR320 S09-2D	32.0	32	156	64	M2003264
LT DR330 S09-2D	33.0	32	159	66	M2003265

2XD DRILL BODIES - SPMG 110408

DESIGNATION	D1	D2	L1	L2	CATALOG #
LT DR340 S11-2D	34.0	40	171	68	M2003710
LT DR350 S11-2D	35.0	40	174	70	M2003711
LT DR360 S11-2D	36.0	40	177	72	M2003712
LT DR370 S11-2D	37.0	40	180	74	M2003713
LT DR380 S11-2D	38.0	40	183	76	M2003714
LT DR390 S11-2D	39.0	40	185	78	M2003715
LT DR400 S11-2D	40.0	40	188	80	M2003716
LT DR410 S11-2D	41.0	40	191	82	M2003717

3 X D DRILL BODIES - SPMG

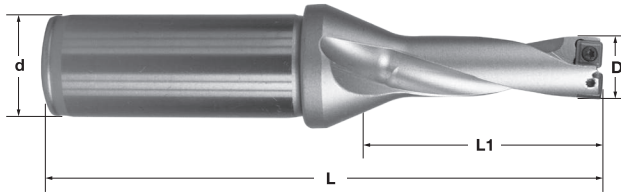

3XD DRILL BODIES - SPMG 050204

DESIGNATION	D1	D2	L1	L2	CATALOG #
LT DR125 S05-3D	12.5	20	107	39	M2003718
LT DR130 S05-3D	13.0	20	107	39	M2003719
LT DR135 S05-3D	13.5	20	110	42	M2003720
LT DR140 S05-3D	14.0	20	110	42	M2003721
LT DR145 S05-3D	14.5	20	114	45	M2003722
LT DR150 S05-3D	15.0	20	114	45	M2003723

3XD DRILL BODIES - SPMG 060204

DESIGNATION	D1	D2	L1	L2	CATALOG #
LT DR160 S06-3D	16.0	25	124	48	M2003266
LT DR170 S06-3D	17.0	25	127	51	M2003267
LT DR175 S06-3D	17.5	25	131	54	M2003700
LT DR180 S06-3D	18.0	25	131	54	M2003268
LT DR185 S06-3D	18.5	25	134	57	M2003701
LT DR190 S06-3D	19.0	25	134	57	M2003269
LT DR200 S06-3D	20.0	25	139	60	M2003270
LT DR210 S06-3D	21.0	25	142	63	M2003271

DRILLING

3 X D DRILL BODIES - SPMG

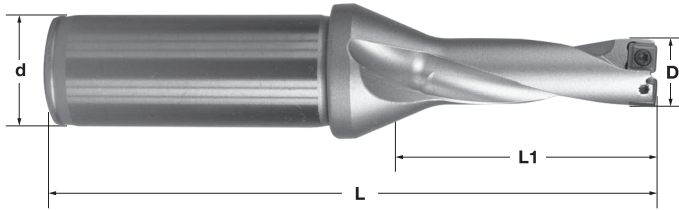

3XD DRILL BODIES - SPMG 07T308

DESIGNATION	D1	D2	L1	L2	CATALOG #
LT DR220 S07-3D	22.0	25	145	66	M2003272
LT DR230 S07-3D	23.0	32	154	69	M2003273
LT DR240 S07-3D	24.0	32	158	72	M2003274
LT DR250 S07-3D	25.0	32	162	75	M2003275
LT DR260 S07-3D	26.0	32	165	78	M2003276
LT DR265 S07-3D	26.5	32	168	81	M2003702
LT DR270 S07-3D	27.0	32	168	81	M2003277

3XD DRILL BODIES - SPMG 090408

DESIGNATION	D1	D2	L1	L2	CATALOG #
LT DR280 S09-3D	28.0	32	172	84	M2003278
LT DR290 S09-3D	29.0	32	175	87	M2003280
LT DR295 S09-3D	29.5	32	181	90	M2003703
LT DR300 S09-3D	30.0	32	181	90	M2003281
LT DR310 S09-3D	31.0	32	185	93	M2003282
LT DR320 S09-3D	32.0	32	188	96	M2003283
LT DR330 S09-3D	33.0	32	192	99	M2003284

3XD DRILL BODIES - SPMG 110408

DESIGNATION	D1	D2	L1	L2	CATALOG #
LT DR340 S11-3D	34.0	40	205	102	M2003724
LT DR350 S11-3D	35.0	40	209	105	M2003725
LT DR360 S11-3D	36.0	40	213	108	M2003726
LT DR370 S11-3D	37.0	40	217	111	M2003727
LT DR380 S11-3D	38.0	40	221	114	M2003728
LT DR390 S11-3D	39.0	40	224	117	M2003729
LT DR400 S11-3D	40.0	40	228	120	M2003730
LT DR410 S11-3D	41.0	40	232	123	M2003731

4 X D DRILL BODIES - SPMG

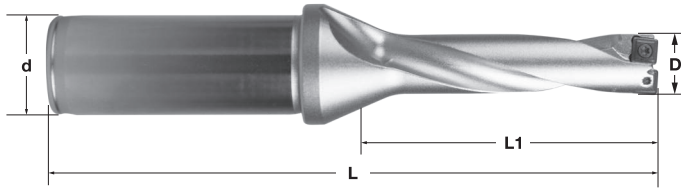

4XD DRILL BODIES* - SPMG 050204

DESIGNATION	D1	D2	L1	L2	CATALOG #
LT DR125 S05-4D	12.5	20	120	52	M2003732
LT DR130 S05-4D	13.0	20	120	52	M2003733
LT DR135 S05-4D	13.5	20	124	56	M2003434
LT DR140 S05-4D	14.0	20	124	56	M2003735
LT DR145 S05-4D	14.5	20	129	60	M2003736
LT DR150 S05-4D	15.0	20	129	60	M2003737

* On Request

4XD DRILL BODIES* - SPMG 060204

DESIGNATION	D1	D2	L1	L2	CATALOG #
LT DR155 S06-4D	15.5	25	140	64	M2003746
LT DR160 S06-4D	16.0	25	140	64	M2003747
LT DR165 S06-4D	16.5	25	144	68	M2003748
LT DR170 S06-4D	17.0	25	144	68	M2003749
LT DR175 S06-4D	17.5	25	149	72	M2003750
LT DR180 S06-4D	18.0	25	149	72	M2003751
LT DR185 S06-4D	18.5	25	153	76	M2003752
LT DR190 S06-4D	19.0	25	153	76	M2004380
LT DR195 S06-4D	19.5	25	159	80	M2003753
LT DR200 S06-4D	20.0	25	159	80	M2003754
LT DR205 S06-4D	20.5	25	163	84	M2003755
LT DR210 S06-4D	21.0	25	163	84	M2003756
LT DR215 S06-4D	21.5	25	167	88	M2003757

* On Request

DRILLING

4 X D DRILL BODIES - SPMG

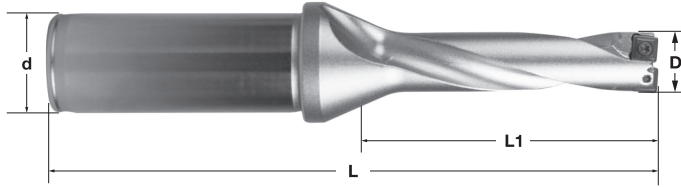

4XD DRILL BODIES* - SPMG 07T308

DESIGNATION	D1	D2	L1	L2	CATALOG #
LT DR220 S07-4D	22.0	25	167	88	M2003758
LT DR225 S07-4D	22.5	32	177	92	M2003759
LT DR230 S07-4D	23.0	32	177	92	M2003760
LT DR235 S07-4D	23.5	32	182	96	M2003761
LT DR240 S07-4D	24.0	32	182	96	M2004381
LT DR245 S07-4D	24.5	32	187	100	M2003762
LT DR250 S07-4D	25.0	32	187	100	M2003763
LT DR255 S07-4D	25.5	32	191	104	M2003764
LT DR260 S07-4D	26.0	32	191	104	M2003765
LT DR265 S07-4D	26.5	32	195	108	M2003766
LT DR270 S07-4D	27.0	32	195	108	M2003767
LT DR275 S07-4D	27.5	32	200	112	M2003768

* On Request

4XD DRILL BODIES* - SPMG 090408

DESIGNATION	D1	D2	L1	L2	CATALOG #
LT DR280 S09-4D	28.0	32	200	112	M2003769
LT DR285 S09-4D	28.5	32	204	116	M2003770
LT DR290 S09-4D	29.0	32	204	116	M2003771
LT DR295 S09-4D	29.5	32	211	120	M2003772
LT DR300 S09-4D	30.0	32	211	120	M2003773
LT DR310 S09-4D	31.0	32	216	124	M2003774
LT DR320 S09-4D	32.0	32	220	128	M2003775
LT DR330 S09-4D	33.0	32	225	132	M2003776

* On Request

4 X D DRILL BODIES - SPMG

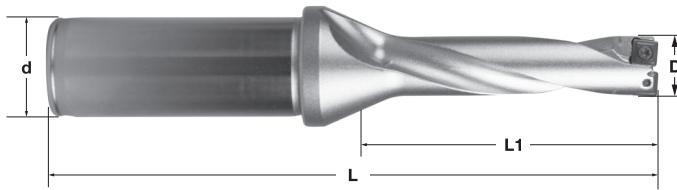

4XD DRILL BODIES* - SPMG 110408

DESIGNATION	D1	D2	L1	L2	CATALOG #
LT DR340 S11-4D	34.0	40	239	136	M2003738
LT DR350 S11-4D	35.0	40	244	140	M2003739
LT DR360 S11-4D	36.0	40	249	144	M2003740
LT DR370 S11-4D	37.0	40	254	148	M2003741
LT DR380 S11-4D	38.0	40	259	152	M2003742
LT DR390 S11-4D	39.0	40	263	156	M2003743
LT DR400 S11-4D	40.0	40	268	160	M2003744
LT DR410 S11-4D	41.0	40	273	164	M2003745

* On Request

DRILL BODY SPARE PARTS

SPARE PARTS PER INSERT	KEY	SCREW
SPMG 050204 NN LT 30	M2004169	M2003820
SPMG 060204 NN LT 30	M2004169	M2003823
SPMG 07T308 NN LT 30	M2002912	M2003824
SPMG 090408 NN LT 30	M2000602	M2003821
SPMG 110408 NN LT 30	M2000602	M2003822

WCMX

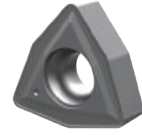

ALPHA

DESIGNATION	GRADE	MATERIAL RECOMMENDATION	L	S	R	DIRECTION	CATALOG #
WCMX 040208 NN	LT 30		4.0	2.38	0.8	NEUTRAL	M3001122
WCMX 050308 NN	LT 30		5.0	3.18	0.8	NEUTRAL	M3001121
WCMX 06T308 NN	LT 30		6.0	3.97	0.8	NEUTRAL	M3000953
WCMX 080412 NN	LT 30		8.0	4.76	1.2	NEUTRAL	M3000954

MATERIAL GROUP	
STEEL	HIGH TEMP ALLOYS
STAINLESS STEEL	HARDENED MATERIAL
CAST IRON	ALU(>8%Si)

CUTTING SPEED



DOC / FEED



TECHNICAL INFORMATION

MACHINING CONDITIONS

TURNING

CUTTING SPEED 186 - 187

DEPTH OF CUT AND FEED 188 - 223

MILLING

CUTTING SPEED 226

DEPTH OF CUT AND FEED 227 - 278

ALU - TURNING AND MILLING

CUTTING SPEED 280

DEPTH OF CUT AND FEED 281 - 282

PARTING AND GROOVING

CUTTING SPEED 284

DEPTH OF CUT AND FEED 285 - 287

SOLID END MILLS

CUTTING SPEED 290

DEPTH OF CUT AND FEED 291 - 302

THREADING - TURNING AND MILLING 304 - 308

DRILLING

CUTTING SPEED 310

DEPTH OF CUT AND FEED 311 - 312

TECHNICAL GUIDE 313

LAMINA MATERIAL GUIDE 327

INSERT INDEX 335

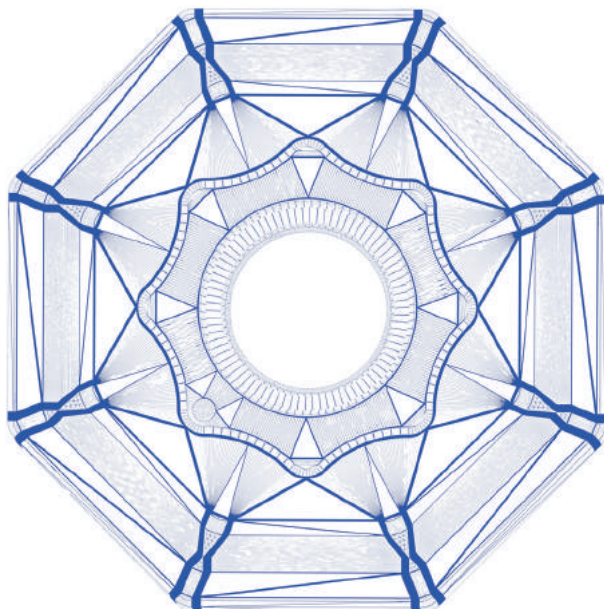

HIGH TECHNOLOGY



MACHINING CONDITIONS

TURNING

MACHINING CONDITIONS - TURNING - CUTTING SPEED (Vc)

LT 10 / LT 1000 — CORNER RADIUS 0.8 AND 1.2

LT 1005 — EXCEPT _NMA

LT 1025 — ALL GEOMETRIES

ALL GEOMETRIES CORNER RADIUS 0.8 AND 1.2															
Material Group	Lamina Gr. N°	Material Examples	Hardness	LT 10 / LT 1000 Vc [m/min]			LT 1005 Vc [m/min]			LT 1025 Vc [m/min]					
				min	max	sugg. start speed	min	max	sugg. start speed	min	max	sugg. start speed			
P	Non Alloyed	1	C35, Ck45, 1020, 1045, 1060, 28Mn6	125 HB	180	330	240	180	430	265	90	330	240		
				190 HB		280	220		365	240		280	220		
				250 HB		250	200		325	220		250	200		
	Low Alloyed	2	42CrMo4, St50, Ck60, 4140, 4340, 100Cr6	180 HB	120	280	200	120	365	220	60	280	200		
				230 HB		250	180		325	200		250	180		
				280 HB		210	150		275	165		210	150		
				350 HB		180	130		235	145		180	130		
	High Alloyed	3	X40CrMoV5, H13, M42, D3, S6-5-2, 12Ni19	220 HB	70	190	140	70	245	155	35	190	140		
				280 HB		150	120		195	130		150	120		
				320 HB		130	100		170	110		130	100		
				350 HB		110	90		145	100		110	90		
	M	Austenitic	4	304, 316, X5CrNi18-9	180 HB	170	270	190	-	-	-	85	270	190	
240 HB				160	220	170	-	-	-	80	220	170			
Duplex		5	X2CrNi23-4, S31500	290 HB	80	150	100	-	-	-	40	150	100		
				310 HB	70	140	90	-	-	-	35	140	90		
Ferritic & Martensitic		6	410, X6Cr17, 17-4PH, 430	200 HB	170	250	190	-	-	-	85	250	190		
				42 HRc	120	190	130	-	-	-	60	190	130		
K	Grey	7	GG20, GG40, EN-GJL-250, N030B	150 HB	170	250	200	170	325	220	-	-	-		
			200 HB	160	230	180	160	300	200	-	-	-			
			250 HB	150	210	160	150	275	175	-	-	-			
	Malleable & Nodular	8	GGG40, GGG70, 50005	150 HB	120	250	180	120	325	200	60	250	180		
200 HB				230		160	300		175	230		160			
250 HB	190	140	245	155	190	140									
S	Fe, Ni & Co based	9	Incoloy 800	240 HB	25	45	32	-	-	-	-	-	-		
			Inconel 700	250 HB		45	30	-	-	-	-	-			
			Stellite 21	350 HB		23	40	28	-	-	-	-	-		
	Ti based	10	TiAl6V4	-	35	55	45	-	-	-	-	-	-		
			T40	-	45	65	55	-	-	-	-	-	-		
H	Steel	11	X100 CrMo13, 440C, G-X260NiCr42	45 HRc	40	50	100	80	40	50	130	90	-	-	-
				50 HRc		90	70	115		75	-	-	-		
				55 HRc		80	60	105		65	-	-	-		
				400 HB		60	50	80		55	-	-	-		
Chilled Cast Iron	Ni-Hard 2	400 HB	60	50	80	55	-	-	-						
White Cast Iron	G-X300CrMo15	55 HRc	30	50	40	30	65	45	-	-	-				
NF	Aluminium	12	AlSi12	130 HB	200	400	280	-	-	-	-	-	-		

MACHINING CONDITIONS - TURNING - CUTTING SPEED (Vc)

LT 10 / LT 1000 — CORNER RADIUS 0.4

LT 1005 — _NMA

Material Group	Lamina Gr. N°	Material Examples	Hardness	CORNER RADIUS 0.4			_ NMA			
				LT 10 / LT 1000 Vc [m/min]			LT 1005 Vc [m/min]			
				min	max	sugg. start speed	min	max	sugg. start speed	
P	1	C35, Ck45, 1020, 1045, 1060, 28Mn6	125 HB	180	330	300	-	-	-	
			190 HB		280	260	-	-	-	
			250 HB		250	240	-	-	-	
	2	42CrMo4, St50, Ck60, 4140, 4340, 100Cr6	180 HB	120	280	260	-	-	-	
			230 HB		250	240	-	-	-	
			280 HB		210	200	-	-	-	
			350 HB		180	180	-	-	-	
	3	X40CrMoV5, H13, M42, D3, S6-5-2, 12Ni19	220 HB	70	190	180	-	-	-	
			280 HB		150	140	-	-	-	
			320 HB		130	120	-	-	-	
			350 HB		110	110	-	-	-	
	M	4	304, 316, X5CrNi18-9	180 HB	170	270	260	-	-	-
240 HB				160		220	210	-	-	-
5		X2CrNiN23-4, S31500	290 HB	80	150	140	-	-	-	
			310 HB		70	140	140	-	-	-
6		410, X6Cr17, 17-4PH, 430	200 HB	170	250	240	-	-	-	
			42 HRc		120	190	180	-	-	-
K	7	GG20, GG40, EN-GJL-250, N030B	150 HB	170	250	240	270	450	350	
			200 HB		160	230	220	200	320	250
			250 HB		150	210	200	170	240	220
	8	GGG40, GGG70, 50005	150 HB	120	250	240	130	260	240	
			200 HB		230	220		230	210	
			250 HB		190	180		190	180	
S	9	Incoloy 800	25	50	40	-	-	-		
		Inconel 700				250 HB	-	-	-	
		Stellite 21				350 HB	23	45	35	-
	10	TiAl6V4	-	35	60	50	-	-	-	
T40		-	45	65	60	-	-	-		
H	11	X100 CrMo13, 440C, G-X260NiCr42	45 HRc	40	100	90	-	-	-	
			50 HRc		90	80	-	-	-	
			55 HRc		80	70	-	-	-	
			Ni-Hard 2		400 HB	60	50	40	60	50
	White Cast Iron	G-X300CrMo15	55 HRc	30	50	40	30	50	40	
NF	12	AlSi12	130 HB	200	400	350	-	-	-	

MACHINING CONDITIONS - TURNING - DEPTH OF CUT AND FEED

CCMT 09T304 NN
 CCMT 120404 NN
 CNMG 120404 NN
 CPMT 09T304 NN
 DCMT 11T304 NN
 DNMG 110404 NN
 DNMG 150404 NN

DNMG 150604 NN
 TCMT 16T304 NN
 TNMG 160404 NN
 TNMG 220404 NN
 TNUX 160404 L
 TNUX 160404 R
 TPMR 160304 NN

VBMT 160404 NN
 VCMT 160404 NN
 VNMG 160404 NN
 WNMG 060404 NN
 WNMG 080404 NN
 WNMP 060404 NN

Material Group	Lamina Gr. N°	Material Examples	Hardness	DOC [mm]		Feed [mm/rev]		Amax [mm²]	Suggested Starting Parameters				
				min	max	min	max		DOC	Feed			
P Non Alloyed Low Alloyed High Alloyed	1	C35, Ck45, 1020, 1045, 1060, 28Mn6	125 HB	0.30	3.0	0.11	0.23	0.60	2.00	0.18			
			190 HB										
			250 HB										
	2	42CrMo4, St50, Ck60, 4140, 4340, 100Cr6	180 HB	0.30	2.50	0.10	0.20	0.50	2.00	0.14			
			230 HB					0.48					
			280 HB		2.00		0.18	0.40					
			350 HB					0.36					
	3	X40CrMoV5, H13, M42, D3, S6-5-2, 12Ni19	220 HB	0.30	2.50	0.09	0.18	0.40	1.70	0.10			
			280 HB					0.16					
			320 HB		2.00		0.14	0.32					
			350 HB					0.26					
	M Austenitic Duplex Ferritic & Martensitic	4	304, 316, X5CrNi18-9	180 HB	0.30	2.50	0.08	0.18	0.32	2.00	0.09		
240 HB				0.08									
5		X2CrNi23-4, S31500	290 HB	0.30	2.00	0.08	0.14	0.20	1.70	0.08			
			310 HB										
6		410, X6Cr17, 17-4PH, 430	200 HB	0.30	2.50	0.08	0.18	0.32	1.70	0.09			
			42 HRc		2.00						0.16	0.26	1.50
K Grey Malleable & Nodular	7	GG20, GG40, EN-GJL-250, N030B	150 HB	0.30	3.00	0.08	0.20	0.64	2.00	0.18			
			200 HB										
			250 HB										
	8	GGG40, GGG70, 50005	150 HB	0.30	2.50	0.08	0.18	0.48	2.00	0.13			
			200 HB					0.40					
			250 HB					0.40					
S Fe, Ni & Co based Ti based	9	Incoloy 800	0.30	2.00	0.09	0.15	0.26	1.30	0.10				
		Inconel 700											
		Stellite 21											
	10	T40	0.30	2.00	0.09	0.16	0.32	1.30	0.14				
		TiAl6V4							0.10				
		-							0.14	0.26	0.10		
H Steel Chilled Cast Iron White Cast Iron	11	X100 CrMo13, 440C, G-X260NiCr42	45 HRc	0.30	1.80	0.05	0.12	0.20	1.40	0.10			
			50 HRc						1.10	0.08			
			55 HRc						1.40	0.09	0.13	0.90	0.06
			400 HB						1.60	0.12	0.17	1.10	0.10
			400 HB						1.40	0.09	0.13	0.90	0.06
			55 HRc						1.40	0.09	0.13	0.90	0.06
NF Aluminium	12	AlSi12	130 HB	0.30	4.00	0.10	0.30	0.70	2.00	0.23			

The depth of cut and feed rate tables are for the geometry and corner radius specified above the table. Refer to cutting speed tables on pages 186 and 187 for recommended materials per grade.

MACHINING CONDITIONS - TURNING - DEPTH OF CUT AND FEED

CCMT 09T308 NN
 CPMT 09T308 NN
 DCMT 11T308 NN
 SCMT 09T308 NN

Material Group	Lamina Gr. N°	Material Examples	Hardness	DOC [mm]		Feed [mm/rev]		Amax [mm²]	Suggested Starting Parameters						
				min	max	min	max		DOC	Feed					
Non Alloyed P High Alloyed	1	C35, Ck45, 1020, 1045, 1060, 28Mn6	125 HB	0.50	4.00	0.21	0.50	1.62	2.70	0.32					
			190 HB				0.45	1.35							
			250 HB												
	2	42CrMo4, St50, Ck60, 4140, 4340, 100Cr6	180 HB	0.50	4.00	0.21	0.45	1.08	2.70	0.29					
			230 HB								3.20				
			280 HB		0.18	0.40	1.08								
			350 HB					2.80		0.90					
	3	X40CrMoV5, H13, M42, D3, S6-5-2, 12Ni19	220 HB	0.50	3.20	0.18	0.40	1.08	2.30	0.27					
			280 HB								2.40				
			320 HB		0.35		0.72								
			350 HB												
	4	304, 316, X5CrNi18-9	180 HB	0.50	4.00	0.20	0.40	1.08	2.70	0.23					
240 HB			0.90					0.20							
M Duplex	5	X2CrNiN23-4, S31500	290 HB	0.50	3.20	0.18	0.35	0.72	2.30	0.22					
			310 HB												
Ferritic & Martensitic	6	410, X6Cr17, 17-4PH, 430	200 HB	0.50	4.00	0.18	0.40	0.63	2.30	0.18					
			42 HRc		3.20				2.00						
K Grey Malleable & Nodular	7	GG20, GG40, EN-GJL-250, N030B	150 HB	0.50	4.00	0.15	0.60	1.80	2.70	0.32					
			200 HB				0.55	1.62							
			250 HB												
	8	GGG40, GGG70, 50005	150 HB	0.50	4.00	0.15	0.50	1.35	2.70	0.27					
			200 HB					1.17							
			250 HB					1.08							
S Fe, Ni & Co based TI based	9	Incoloy 800	0.50	2.40	0.20	0.35	0.63	1.80	0.25						
		Inconel 700													
		Stellite 21													
	10	T40	0.50	3.20	0.20	0.40	0.72	1.80	0.30						
TiAl6V4		2.40		0.35					0.63	0.27					
H Steel Chilled Cast Iron White Cast Iron	11	X100 CrMo13, 440C, G-X260NiCr42	45 HRc	0.50	1.20	0.11	0.30	0.54	1.80	0.23					
			50 HRc							1.60	0.25	0.36	1.40	0.16	
			55 HRc							1.20	0.20	0.27	0.90		
			400 HB							1.60	0.25	0.36	1.40		
			G-X300CrMo15							55 HRc	1.20	0.20	0.27	0.90	0.14
NF Aluminium	12	AlSi12	130 HB	0.50	4.80	0.20	0.60	1.62	2.70	0.36					

The depth of cut and feed rate tables are for the geometry and corner radius specified above the table. Refer to cutting speed tables on pages 186 and 187 for recommended materials per grade.

MACHINING CONDITIONS - TURNING - DEPTH OF CUT AND FEED

CCMT 120412 NN

Material Group	Lamina Gr. N°	Material Examples	Hardness	DOC [mm]		Feed [mm/rev]		Amax [mm ²]	Suggested Starting Parameters				
				min	max	min	max		DOC	Feed			
P	Non Alloyed	C35, Ck45, 1020, 1045, 1060, 28Mn6	125 HB	0.50	5.00	0.21	0.60	2.16	3.00	0.42			
			190 HB										
			250 HB										
	Low Alloyed	2	42CrMo4, S150, Ck60, 4140, 4340, 100Cr6	180 HB	0.50	5.00	0.21	0.54	1.44	3.00	0.38		
				230 HB		4.00							
				280 HB		3.50	0.18	0.48			1.20	0.36	
				350 HB									
	High Alloyed	3	X40CrMoV5, H13, M42, D3, S6-5-2, 12Ni19	220 HB	0.50	4.00	0.18	0.48	1.44	2.50	0.36		
				280 HB									
				320 HB		3.00	0.18	0.42			0.96	2.50	0.34
				350 HB									
	M	Austenitic	4	304, 316, X5CrNi18-9	0.50	5.00	0.20	0.48	1.44	3.00	0.30		
1.20									0.26				
Duplex		5	X2CrNiN23-4, S31500	290 HB	0.50	4.00	0.18	0.42	0.96	2.50	0.29		
				310 HB									
Ferritic & Martensitic		6	410, X6Cr17, 17-4PH, 430	200 HB	0.50	5.00	0.18	0.48	0.84	2.50	0.24		
				42 HRc		4.00				2.20			
K	Grey	7	GG20, GG40, EN-GJL-250, N030B	0.50	5.00	0.15	0.72	2.40	3.00	0.42			
								2.16					
	Malleable & Nodular	8	GGG40, GGG70, 50005	150 HB	0.50	5.00	0.15	0.60	1.80	3.00	0.36		
				200 HB					1.56				
250 HB		1.44											
S	Fe, Ni & Co based	9	Incoloy 800	0.50	3.00	0.20	0.42	0.84	2.00	0.34			
			Inconel 700										
			Stellite 21										
	Ti based	10	T40	0.50	4.00	0.20	0.48	0.96	2.00	0.40			
TiAl6V4			3.00		0.42					0.84	0.36		
H	Steel	11	X100 CrMo13, 440C, G-X260NiCr42	0.50	2.50	0.11	0.36	0.72	2.00	0.30			
											50 HRc		
											55 HRc		
											400 HB		
											55 HRc		
Chilled Cast Iron	Ni-Hard 2	400 HB	0.50	2.00	0.11	0.30	0.48	1.50	0.22				
										400 HB			
White Cast Iron	G-X300CrMo15	55 HRc	0.50	1.50	0.11	0.24	0.36	1.00	0.18				
										55 HRc			
NF	Aluminium	12	AlSi12	0.50	6.00	0.20	0.72	2.16	3.00	0.48			

The depth of cut and feed rate tables are for the geometry and corner radius specified above the table. Refer to cutting speed tables on pages 186 and 187 for recommended materials per grade.

MACHINING CONDITIONS - TURNING - DEPTH OF CUT AND FEED

CCMT 060204 NN
 CPMT 060204 NN
 DCMT 070204 NN

TCMT 110204 NN
 VBMT 110304 NN

Material Group	Lamina Gr. N°	Material Examples	Hardness	DOC [mm]		Feed [mm/rev]		Amax [mm²]	Suggested Starting Parameters	
				min	max	min	max		DOC	Feed
P Non Alloyed Low Alloyed High Alloyed	1	C35, Ck45, 1020, 1045, 1060, 28Mn6	125 HB	0.3	2.1	0.08	0.20	0.32	1.0	0.14
			190 HB							
			250 HB							
	2	42CrMo4, S150, Ck60, 4140, 4340, 100Cr6	180 HB	0.3	1.8	0.08	0.17	0.30	1.0	0.11
			230 HB							
			280 HB							
			350 HB							
	3	X40CrMoV5, H13, M42, D3, S6-5-2, 12Ni19	220 HB	0.3	1.8	0.07	0.15	0.25	0.9	0.08
			280 HB							
			320 HB							
			350 HB							
	M Austenitic Duplex Ferritic & Martensitic	4	304, 316, X5CrNi18-9	180 HB	0.3	1.8	0.06	0.15	0.20	1.0
240 HB										
5		X2CrNiN23-4, S31500	290 HB	0.3	1.4	0.06	0.12	0.12	0.85	0.06
			310 HB							
6		410, X6Cr17, 17-4PH, 430	200 HB	0.3	1.8	0.06	0.15	0.20	0.9	0.08
			42 HRc		1.4		0.14	0.16		0.07
K Grey Malleable & Nodular	7	GG20, GG40, EN-GJL-250, N030B	150 HB	0.3	2.1	0.06	0.17	0.40	1.0	0.16
			200 HB							
			250 HB							
8	GGG40, GGG70, 50005	150 HB	0.3	1.8	0.06	0.15	0.30	1.0	0.14	
		200 HB								
		250 HB								
S Fe, Ni & Co based Ti based	9	Incoloy 800	0.3	1.4	0.08	0.13	0.16	0.7	0.08	
		Inconel 700								
		Stellite 21								
	10	T40	0.3	1.4	0.07	0.12	0.16	0.7	0.08	
		TiAl6V4							-	0.14
H Steel Chilled Cast Iron White Cast Iron	11	X100 CrMo13, 440C, G-X260NiCr42	45 HRc	0.3	1.3	0.04	0.1	0.12	0.7	0.08
			50 HRc		1.1		0.09	0.10	0.6	0.06
			55 HRc		1.0		0.08	0.08	0.5	0.05
			Ni-Hard 2	0.3	1.1		0.1	0.11	0.6	0.08
			G-X300CrMo15		1.0		0.08	0.08	0.5	0.05
NF Aluminium	12	AlSi12	130 HB	0.3	2.8	0.08	0.26	0.44	1.0	0.18

The depth of cut and feed rate tables are for the geometry and corner radius specified above the table. Refer to cutting speed tables on pages 186 and 187 for recommended materials per grade.

MACHINING CONDITIONS - TURNING - DEPTH OF CUT AND FEED

CCMT 120408 NN

Material Group	Lamina Gr. N°	Material Examples	Hardness	DOC [mm]		Feed [mm/rev]		Amax [mm ²]	Suggested Starting Parameters						
				min	max	min	max		DOC	Feed					
P	Non Alloyed	C35, Ck45, 1020, 1045, 1060, 28Mn6	125 HB	0.50	5.00	0.21	0.50	1.80	3.00	0.35					
			190 HB				0.45								
			250 HB				0.45								
	Low Alloyed	2	42CrMo4, S150, Ck60, 4140, 4340, 100Cr6	180 HB	0.50	5.00	0.21	0.45	1.20	3.00	0.32				
				230 HB								4.00			
				280 HB			3.50	0.18	0.40	1.00	2.70				
				350 HB											
	High Alloyed	3	X40CrMoV5, H13, M42, D3, S6-5-2, 12Ni19	220 HB	0.50	4.00	0.18	0.40	1.20	2.50	0.30				
				280 HB											
				320 HB											
				350 HB											
	M	Austenitic	4	304, 316, X5CrNi18-9	0.50	5.00	0.20	0.40	1.20	3.00	0.25				
240 HB				1.00					0.22						
Duplex		5	X2CrNiN23-4, S31500	290 HB	0.50	4.00	0.18	0.35	0.80	2.50	0.24				
				310 HB											
Ferritic & Martensitic		6	410, X6Cr17, 17-4PH, 430	200 HB	0.50	5.00	0.18	0.40	0.70	2.50	0.20				
				42 HRc						4.00		2.20			
K	Grey	7	GG20, GG40, EN-GJL-250, N030B	0.50	5.00	0.15	0.60	2.00	3.00	0.35					
			200 HB					1.80							
	Malleable & Nodular	8	GGG40, GGG70, 50005	150 HB	0.50	5.00	0.15	0.50	1.50	3.00	0.30				
				200 HB					1.30						
S	Fe, Ni & Co based	9	Incoloy 800	0.50	3.00	0.20	0.35	0.70	2.00	0.28					
			Inconel 700								250 HB				
Ti based	10	TiAl6V4	Stellite 21	0.50	3.00	0.20	0.35	0.70	2.00	0.30					
			T40								-	4.00	0.40	0.80	0.33
H	Steel	11	X100 CrMo13, 440C, G-X260NiCr42	0.50	1.50	0.11	2.50	0.20	0.30	0.60	2.00	0.25			
			45 HRc				2.00					0.25	0.40	1.50	0.20
			50 HRc				1.50					0.20	0.30	1.00	0.18
			55 HRc				2.00					0.25	0.40	1.50	
			Ni-Hard 2				400 HB					2.00	0.25	0.40	1.50
Chilled Cast Iron	G-X300CrMo15	400 HB	0.50	1.50	0.20	0.30	1.00	1.50	0.15						
White Cast Iron		55 HRc													
NF	Aluminium	12	AlSi12	130 HB	0.50	6.00	0.20	0.60	1.80	3.00	0.40				

The depth of cut and feed rate tables are for the geometry and corner radius specified above the table. Refer to cutting speed tables on pages 186 and 187 for recommended materials per grade.

MACHINING CONDITIONS - TURNING - DEPTH OF CUT AND FEED

RCMT 0602 M0

Material Group	Lamina Gr. N°	Material Examples	Hardness	DOC [mm]		Feed [mm/rev]		Amax [mm²]	Suggested Starting Parameters		
				min	max	min	max		DOC	Feed	
P	Non Alloyed	C35, Ck45, 1020, 1045, 1060, 28Mn6	125 HB	0.50	2.00	0.15	0.40	0.64	1.00	0.35	
			190 HB							0.30	
			250 HB							0.30	
	Low Alloyed	2	42CrMo4, St50, Ck60, 4140, 4340, 100Cr6	180 HB	0.50	2.00	0.15	0.35	0.56	1.00	0.30
				230 HB							
				280 HB							
				350 HB							
	High Alloyed	3	X40CrMoV5, H13, M42, D3, S6-5-2, 12Ni19	220 HB	0.50	2.00	0.13	0.30	0.48	1.00	0.30
				280 HB							0.28
				320 HB							0.28
				350 HB							0.24
	M	Austenitic	4	304, 316, X5CrNi18-9	0.50	2.00	0.14	0.35	0.32	1.00	0.30
240 HB											0.29
Duplex		5	X2CrNiN23-4, S31500	290 HB	0.50	1.50	0.13	0.30	0.30	1.00	0.28
				310 HB							
Ferritic & Martensitic		6	410, X6Cr17, 17-4PH, 430	200 HB	0.50	2.00	0.15	0.35	0.32	1.00	0.25
				42 HRc							0.22
K	Grey	7	GG20, GG40, EN-GJL-250, N030B	0.50	2.00	0.11	0.45	0.65	1.00	0.35	
										200 HB	
										250 HB	
	Malleable & Nodular	8	GGG40, GGG70, 50005	150 HB	0.50	2.00	0.11	0.35	0.60	1.00	0.30
200 HB											
S	Fe, Ni & Co based	9	Incoloy 800	0.50	1.50	0.13	0.30	0.30	1.00	0.28	
			Inconel 700								
			Stellite 21								
	Ti based	10	T40	0.50	1.50	0.13	0.32	0.32	1.00	0.30	
			TiAl6V4							0.28	
			-								
H	Steel	11	X100 CrMo13, 440C, G-X260NiCr42	0.50	1.20	0.05	0.22	0.20	0.90	0.18	
										50 HRc	0.16
										55 HRc	0.12
										400 HB	0.18
	Chilled Cast Iron	Ni-Hard 2	400 HB	0.30	0.80	0.05	0.22	0.17	0.90	0.18	
White Cast Iron	G-X300CrMo15	55 HRc	0.30	0.80	0.05	0.14	0.10	0.60	0.12		
NF	Aluminium	12	AISI12	130 HB	0.50	2.00	0.15	0.40	0.70	1.00	0.35

The depth of cut and feed rate tables are for the geometry and corner radius specified above the table. Refer to cutting speed tables on pages 186 and 187 for recommended materials per grade.

MACHINING CONDITIONS - TURNING - DEPTH OF CUT AND FEED

RCMT 0803 M0

Material Group	Lamina Gr. N°	Material Examples	Hardness	DOC [mm]		Feed [mm/rev]		Amax [mm ²]	Suggested Starting Parameters		
				min	max	min	max		DOC	Feed	
P	Non Alloyed	C35, Ck45, 1020, 1045, 1060, 28Mn6	125 HB	0.50	2.40	0.15	0.40	0.77	1.20	0.35	
			190 HB							0.30	
			250 HB							0.30	
	Low Alloyed	2	42CrMo4, S150, Ck60, 4140, 4340, 100Cr6	180 HB	0.50	2.40	0.15	0.35	0.67	1.20	0.30
				230 HB							
				280 HB							
				350 HB							
	High Alloyed	3	X40CrMoV5, H13, M42, D3, S6-5-2, 12Ni19	220 HB	0.50	2.40	0.13	0.30	0.35	1.20	0.30
				280 HB							0.28
				320 HB							0.24
				350 HB							0.24
	M	Austenitic	4	304, 316, X5CrNi18-9	0.50	2.40	0.14	0.35	0.38	1.20	0.30
240 HB											0.29
Duplex		5	X2CrNiN23-4, S31500	290 HB	0.50	1.80	0.13	0.30	0.36	1.20	0.28
				310 HB							
Ferritic & Martensitic		6	410, X6Cr17, 17-4PH, 430	200 HB	0.50	2.40	0.15	0.35	0.38	1.20	0.25
				42 HRc							0.22
K	Grey	7	GG20, GG40, EN-GJL-250, N030B	0.50	2.40	0.11	0.45	0.84	1.20	0.35	
											200 HB
	Malleable & Nodular	8	GGG40, GGG70, 50005	150 HB	0.50	2.40	0.11	0.35	0.72	1.20	0.30
				200 HB							
S	Fe, Ni & Co based	9	Incoloy 800	0.50	1.80	0.13	0.30	0.36	1.20	0.28	
			Inconel 700								
			Stellite 21								
	Ti based	10	T40	0.50	1.80	0.13	0.32	0.38	1.20	0.30	
			TiAl6V4							0.28	
			-								
H	Steel	11	X100 CrMo13, 440C, G-X260NiCr42	0.50	1.40	0.05	0.22	0.24	1.10	0.18	
										50 HRc	0.16
										55 HRc	0.12
										400 HB	0.18
										55 HRc	0.12
Chilled Cast Iron	Ni-Hard 2	400 HB	0.50	1.40	0.05	0.22	0.20	1.10	0.18		
									55 HRc	0.12	
White Cast Iron	G-X300CrMo15	55 HRc	0.50	1.00	0.05	0.14	0.12	0.70	0.12		
									55 HRc	0.12	
NF	Aluminium	12	AlSi12	130 HB	0.50	2.40	0.15	0.40	0.84	1.20	0.35

The depth of cut and feed rate tables are for the geometry and corner radius specified above the table. Refer to cutting speed tables on pages 186 and 187 for recommended materials per grade.

MACHINING CONDITIONS - TURNING - DEPTH OF CUT AND FEED

RCMT 10T3 M0

Material Group	Lamina Gr. N°	Material Examples	Hardness	DOC [mm]		Feed [mm/rev]		Amax [mm²]	Suggested Starting Parameters							
				min	max	min	max		DOC	Feed						
P Non Alloyed Low Alloyed High Alloyed	1	C35, Ck45, 1020, 1045, 1060, 28Mn6	125 HB	0.50	2.80	0.15	0.40	0.90	1.40	0.35						
			190 HB							2.10	0.30					
			250 HB													
	2	42CrMo4, St50, Ck60, 4140, 4340, 100Cr6	180 HB	0.50	2.80	0.15	0.35		1.40	0.30	0.78					
			230 HB								0.67					
			280 HB								0.56					
			350 HB								0.50					
	3	X40CrMoV5, H13, M42, D3, S6-5-2, 12Ni19	220 HB	0.50	2.80	0.13	0.30	0.35	0.67	1.40	0.30					
			280 HB								0.56					
			320 HB								0.45					
			350 HB								0.36					
	M Austenitic Duplex Ferritic & Martensitic	4	304, 316, X5CrNi18-9	180 HB	0.50	2.80	0.14	0.35	0.45	1.40	0.30					
240 HB				0.32							0.29					
5		X2CrNiN23-4, S31500	290 HB	0.50	2.10	0.13	0.30	0.42	1.40	0.28						
			310 HB													
6		410, X6Cr17, 17-4PH, 430	200 HB	0.50	2.80	0.15	0.35	0.45	1.40	0.25						
			42 HRc								0.30	0.42	0.22			
K Grey Malleable & Nodular	7	GG20, GG40, EN-GJL-250, N030B	150 HB	0.50	2.80	0.11	0.45	0.98	1.40	0.35						
			200 HB								0.91					
			250 HB								0.84					
	8	GGG40, GGG70, 50005	150 HB	0.50	2.80	0.11	0.35	0.84	1.40	0.30						
			200 HB								0.70					
			250 HB								0.63					
S Fe, Ni & Co based Ti based	9	Incoloy 800	0.50	2.10	0.13	0.30	0.42	1.40	0.28							
		Inconel 700								250 HB						
		Stellite 21								350 HB						
	10	T40	0.50	2.10	0.13	0.32	0.45	1.40	0.30							
		TiAl6V4								-	0.30	0.42	0.28			
										-						
H Steel Chilled Cast Iron White Cast Iron	11	X100 CrMo13, 440C, G-X260NiCr42	45 HRc	0.50	1.70	0.05	0.22	0.28	1.30	0.18						
			50 HRc								1.40	0.18	0.24	1.00	0.16	
			55 HRc								1.10	0.14	0.17	0.80	0.12	
			Ni-Hard 2								400 HB	1.70	0.22	0.24	1.30	0.18
			G-X300CrMo15								55 HRc	0.30	1.10	0.05	0.14	0.14
NF Aluminium	12	AISI12	130 HB	0.50	2.80	0.15	0.40	0.98	1.40	0.35						

The depth of cut and feed rate tables are for the geometry and corner radius specified above the table. Refer to cutting speed tables on pages 186 and 187 for recommended materials per grade.

MACHINING CONDITIONS - TURNING - DEPTH OF CUT AND FEED

RCMT 1204 M0

Material Group	Lamina Gr. N°	Material Examples	Hardness	DOC [mm]		Feed [mm/rev]		Amax [mm ²]	Suggested Starting Parameters			
				min	max	min	max		DOC	Feed		
P	Non Alloyed	C35, Ck45, 1020, 1045, 1060, 28Mn6	125 HB	0.50	3.20	0.15	0.40	1.54	2.00	0.37		
			190 HB									
			250 HB									
	Low Alloyed	2	42CrMo4, S150, Ck60, 4140, 4340, 100Cr6	180 HB	0.50	3.20	0.15	0.35	1.34	2.00	0.32	
				230 HB								
				280 HB								
				350 HB								
	High Alloyed	3	X40CrMoV5, H13, M42, D3, S6-5-2, 12Ni19	220 HB	0.50	3.20	0.13	0.35	1.15	2.00	0.32	
				280 HB								
				320 HB								
	M	Austenitic	4	304, 316, X5CrNi18-9	180 HB	0.50	3.20	0.14	0.35	0.77	2.00	0.32
					240 HB							
Duplex		5	X2CrNiN23-4, S31500	290 HB	0.50	2.40	0.13	0.30	0.72	2.00	0.29	
				310 HB								
Ferritic & Martensitic		6	410, X6Cr17, 17-4PH, 430	200 HB	0.50	3.20	0.15	0.35	0.77	2.00	0.26	
				42 HRc								
K		Grey	7	GG20, GG40, EN-GJL-250, N030B	150 HB	0.50	3.20	0.11	0.45	1.68	2.00	0.37
					200 HB							
					250 HB							
		Malleable & Nodular	8	GGG40, GGG70, 50005	150 HB	0.50	3.20	0.11	0.35	1.44	2.00	0.32
					200 HB							
					250 HB							
S	Fe, Ni & Co based	9	Incoloy 800	0.50	2.40	0.13	0.30	0.72	2.00	0.29		
			Inconel 700									
			Stellite 21									
	Ti based	10	T40	0.50	2.40	0.13	0.32	0.77	2.00	0.32		
			TiAl6V4									
			-									
H	Steel	11	X100 CrMo13, 440C, G-X260NiCr42	45 HRc	0.50	1.90	0.05	0.22	0.48	1.80	0.19	
				50 HRc								
				55 HRc								
	Chilled Cast Iron White Cast Iron	11	Ni-Hard 2 G-X300CrMo15	400 HB	0.30	1.30	0.14	0.22	0.41	1.80	0.19	
				55 HRc								
				55 HRc								
NF	Aluminium	12	AlSi12	130 HB	0.50	3.20	0.15	0.40	1.68	2.00	0.37	

The depth of cut and feed rate tables are for the geometry and corner radius specified above the table. Refer to cutting speed tables on pages 186 and 187 for recommended materials per grade.

MACHINING CONDITIONS - TURNING - DEPTH OF CUT AND FEED

SCMT 09T304 NN

Material Group	Lamina Gr. N°	Material Examples	Hardness	DOC [mm]		Feed [mm/rev]		Amax [mm²]	Suggested Starting Parameters	
				min	max	min	max		DOC	Feed
P	Non Alloyed	C35, Ck45, 1020, 1045, 1060, 28Mn6	125 HB	0.3	4.00	0.11	0.26	0.72	2.50	0.18
			190 HB		3.30		0.25	0.62		
			250 HB				0.23	0.58		
	Low Alloyed	42CrMo4, S150, Ck60, 4140, 4340, 100Cr6	180 HB	0.3	3.30	0.10	0.23	0.60	2.50	0.14
			230 HB					0.58		
			280 HB		2.70		0.21	0.48		0.13
			350 HB					0.43		
	High Alloyed	X40CrMoV5, H13, M42, D3, S6-5-2, 12Ni19	220 HB	0.3	3.30	0.09	0.21	0.48	2.10	0.10
			280 HB				0.18			
			320 HB		2.70		0.16	0.38	2.10	0.10
			350 HB					0.31		
	M	Austenitic	304, 316, X5CrNi18-9	180 HB	0.3	3.30	0.08	0.21	0.38	2.50
240 HB				0.31					0.08	
Duplex		X2CrNiN23-4, S31500	290 HB	0.3	2.70	0.08	0.16	0.24	2.10	0.08
			310 HB							
Ferritic & Martensitic		410, X6Cr17, 17-4PH, 430	200 HB	0.3	3.30	0.08	0.21	0.38	2.10	0.09
			42 HRc		2.70		0.18	0.31	1.90	0.08
K	Grey	GG20, GG40, EN-GJL-250, N030B	150 HB	0.3	4.00	0.08	0.23	0.77	2.50	0.18
			200 HB					0.72		
			250 HB							
	Malleable & Nodular	GGG40, GGG70, 50005	150 HB	0.3	3.30	0.08	0.21	0.58	2.50	0.13
200 HB			0.48							
250 HB										
S	Fe, Ni & Co based	Incoloy 800	0.3	2.70	0.09	0.17	0.31	1.60	0.10	
		Inconel 700								
		Stellite 21								
	Ti based	T40	-	0.3	2.70	0.09	0.18	0.38	1.60	0.14
TiAl6V4			-				0.16	0.31		0.10
H	Steel	X100 CrMo13, 440C, G-X260NiCr42	45 HRc	0.3	2.40	0.05	0.14	0.24	1.80	0.10
			50 HRc		2.00		0.12	0.20	1.40	0.08
			55 HRc		1.90		0.10	0.16	1.10	0.06
			Ni-Hard 2		2.10		0.14	0.20	1.40	0.10
			G-X300CrMo15		1.90		0.10	0.16	1.10	0.06
Chilled Cast Iron										
White Cast Iron										
NF	Aluminium	AlSi12	130 HB	0.3	5.30	0.10	0.35	0.84	2.50	0.23

The depth of cut and feed rate tables are for the geometry and corner radius specified above the table. Refer to cutting speed tables on pages 186 and 187 for recommended materials per grade.

MACHINING CONDITIONS - TURNING - DEPTH OF CUT AND FEED

TCMT 110208 NN

Material Group	Lamina Gr. N°	Material Examples	Hardness	DOC [mm]		Feed [mm/rev]		Amax [mm ²]	Suggested Starting Parameters		
				min	max	min	max		DOC	Feed	
P	Non Alloyed	C35, Ck45, 1020, 1045, 1060, 28Mn6	125 HB	0.30	2.10	0.08	0.20	0.37	1.00	0.14	
			190 HB								
			250 HB								
	Low Alloyed	2	42CrMo4, S150, Ck60, 4140, 4340, 100Cr6	180 HB	0.30	1.80	0.08	0.17	0.31	1.00	0.11
				230 HB							
				280 HB							
				350 HB							
	High Alloyed	3	X40CrMoV5, H13, M42, D3, S6-5-2, 12Ni19	220 HB	0.30	1.80	0.07	0.15	0.25	0.90	0.08
				280 HB							
				320 HB							
				350 HB							
	M	Austenitic	4	304, 316, X5CrNi18-9	0.30	1.80	0.06	0.15	0.20	1.00	0.07
240 HB											
Duplex		5	X2CrNiN23-4, S31500	290 HB	0.30	1.40	0.06	0.12	0.12	0.90	0.06
				310 HB							
Ferritic & Martensitic		6	410, X6Cr17, 17-4PH, 430	200 HB	0.30	1.80	0.06	0.15	0.20	0.90	0.07
				42 HRc							
K	Grey	7	GG20, GG40, EN-GJL-250, N030B	0.30	2.10	0.06	0.17	0.40	1.00	0.14	
											200 HB
											250 HB
	Malleable & Nodular	8	GGG40, GGG70, 50005	150 HB	0.30	1.80	0.06	0.15	0.30	1.00	0.10
				200 HB							
				250 HB							
S	Fe, Ni & Co based	9	Incoloy 800	0.30	1.40	0.07	0.13	0.16	0.70	0.08	
			Inconel 700								
			Stellite 21								
	Ti based	10	T40	0.30	1.40	0.07	0.14	0.20	0.70	0.11	
			TiAl6V4								
			-								
H	Steel	11	X100 CrMo13, 440C, G-X260NiCr42	0.30	1.30	0.04	0.10	0.12	0.70	0.08	
											45 HRc
											50 HRc
											55 HRc
											400 HB
											55 HRc
Chilled Cast Iron	Ni-Hard 2	400 HB	0.30	1.10	0.04	0.10	0.11	0.60	0.08		
										400 HB	
White Cast Iron	G-X300CrMo15	55 HRc	0.30	1.00	0.04	0.08	0.08	0.50	0.05		
										55 HRc	
NF	Aluminium	12	AlSi12	0.30	2.80	0.08	0.26	0.43	1.00	0.18	

The depth of cut and feed rate tables are for the geometry and corner radius specified above the table. Refer to cutting speed tables on pages 186 and 187 for recommended materials per grade.

MACHINING CONDITIONS - TURNING - DEPTH OF CUT AND FEED

TCMT 16T312 NN

Material Group	Lamina Gr. N°	Material Examples	Hardness	DOC [mm]		Feed [mm/rev]		Amax [mm²]	Suggested Starting Parameters		
				min	max	min	max		DOC	Feed	
P	Non Alloyed	C35, Ck45, 1020, 1045, 1060, 28Mn6	125 HB	0.50	5.00	0.21	0.48	1.94	3.00	0.41	
			190 HB							0.38	
			250 HB							0.36	
	Low Alloyed	2	42CrMo4, S150, Ck60, 4140, 4340, 100Cr6	180 HB	0.50	5.00	0.21	0.43	1.30	3.00	0.35
				230 HB							4.00
				280 HB		3.50	0.18	0.38	1.08	2.70	
				350 HB							0.32
	High Alloyed	3	X40CrMoV5, H13, M42, D3, S6-5-2, 12Ni19	220 HB	0.50	4.00	0.18	0.38	1.30	2.50	0.32
				280 HB							
				320 HB		3.00	0.33	0.86	2.20	0.30	
				350 HB							0.30
	M	Austenitic	4	304, 316, X5CrNi18-9	0.50	5.00	0.20	0.38	1.30	3.00	0.27
1.08									0.24		
Duplex		5	X2CrNiN23-4, S31500	290 HB	0.50	4.00	0.18	0.33	0.86	2.50	0.26
				310 HB							
Ferritic & Martensitic		6	410, X6Cr17, 17-4PH, 430	200 HB	0.50	5.00	0.18	0.38	0.76	2.50	0.22
				42 HRc		4.00				2.20	
K	Grey	7	GG20, GG40, EN-GJL-250, N030B	0.50	5.00	0.15	0.57	2.16	3.00	0.38	
								1.94			
								0.52			
	Malleable & Nodular	8	GGG40, GGG70, 50005	150 HB	0.50	5.00	0.15	0.48	1.62	3.00	0.32
				200 HB					1.40		
				250 HB					1.30		
S	Fe, Ni & Co based	9	Incoloy 800	0.50	3.00	0.20	0.33	0.76	2.00	0.30	
			Inconel 700								
			Stellite 21								
	Ti based	10	T40	0.50	3.50	0.20	0.38	0.86	2.00	0.36	
TiAl6V4			3.00		0.33					0.76	0.32
H	Steel	11	X100 CrMo13, 440C, G-X260NiCr42	0.50	1.50	0.11	2.50	0.29	0.65	2.00	0.27
							50 HRc	2.00	0.24	0.43	1.50
	55 HRc						2.00	0.19	0.32	1.00	
	400 HB						2.00	0.24	0.43	1.50	
	Chilled Cast Iron						Ni-Hard 2	400 HB	0.50	1.50	0.11
White Cast Iron	G-X300CrMo15	55 HRc									
NF	Aluminum	12	AlSi12	130 HB	0.50	6.00	0.20	0.57	1.94	3.00	0.43

The depth of cut and feed rate tables are for the geometry and corner radius specified above the table. Refer to cutting speed tables on pages 186 and 187 for recommended materials per grade.

MACHINING CONDITIONS - TURNING - DEPTH OF CUT AND FEED

TCMT 16T308 NN
TPMR 160308 NN

Material Group	Lamina Gr. N°	Material Examples	Hardness	DOC [mm]		Feed [mm/rev]		Amax [mm ²]	Suggested Starting Parameters			
				min	max	min	max		DOC	Feed		
P	Non Alloyed	C35, Ck45, 1020, 1045, 1060, 28Mn6	125 HB	0.50	5.00	0.21	0.43	1.62	3.00	0.34		
			190 HB							0.32		
			250 HB							0.30		
	Low Alloyed	2	42CrMo4, S150, Ck60, 4140, 4340, 100Cr6	180 HB	0.50	5.00	0.21	0.3	1.08	3.00	0.29	
				230 HB		4.00						
				280 HB		3.50	0.18	0.34	0.90	2.70		
				350 HB						0.27		
	High Alloyed	3	X40CrMoV5, H13, M42, D3, S6-5-2, 12Ni19	220 HB	0.50	4.00	0.18	0.34	1.08	2.50	0.27	
				280 HB							3.00	
				320 HB		3.00	0.18	0.30	0.72	2.20		
				350 HB						0.25		
	M	Austenitic	4	304, 316, X5CrNi18-9	0.50	5.00	0.20	0.34	1.08	3.00	0.23	
240 HB				0.90					0.20			
Duplex		5	X2CrNiN23-4, S31500	290 HB	0.50	4.00	0.18	0.30	0.72	2.50	0.22	
				310 HB								
Ferritic & Martensitic		6	410, X6Cr17, 17-4PH, 430	200 HB	0.50	5.00	0.18	0.34	0.63	2.50	0.18	
				42 HRc		4.00				2.20		
K	Grey	7	GG20, GG40, EN-GJL-250, N030B	0.50	5.00	0.15	0.51	1.80	3.00	0.32		
			200 HB					1.62				
	Malleable & Nodular	8	GGG40, GGG70, 50005	150 HB	0.50	5.00	0.15	0.43	1.35	3.00	0.27	
				200 HB					1.17			
S	Fe, Ni & Co based	9	Incoloy 800	0.50	3.00	0.20	0.30	0.63	2.00	0.25		
			Inconel 700								250 HB	
			Stellite 21								350 HB	
	Ti based	10	T40	0.50	3.50	0.20	0.34	0.72	2.00	0.30		
			TiAl6V4		3.00					0.30	0.63	0.27
H	Steel	11	X100 CrMo13, 440C, G-X260NiCr42	0.50	1.50	0.11	2.50	0.26	0.54	2.00	0.23	
			45 HRc				2.00	0.21	0.36	1.50	0.18	
	50 HRc		1.50				0.17	0.27	1.00	0.16		
	55 HRc		2.00				0.21	0.36	1.50			
	Ni-Hard 2		400 HB				2.00	0.21	0.36		1.50	
Chilled Cast Iron	11	G-X300CrMo15	400 HB	0.50	1.50	0.17	0.27	1.00	0.14			
White Cast Iron			55 HRc									
NF	Aluminium	12	AlSi12	0.50	6.00	0.20	0.51	1.62	3.00	0.36		

The depth of cut and feed rate tables are for the geometry and corner radius specified above the table. Refer to cutting speed tables on pages 186 and 187 for recommended materials per grade.

MACHINING CONDITIONS - TURNING - DEPTH OF CUT AND FEED

VCMT 160408 NN
VBMT 160408 NN

Material Group	Lamina Gr. N°	Material Examples	Hardness	DOC [mm]		Feed [mm/rev]		Amax [mm²]	Suggested Starting Parameters		
				min	max	min	max		DOC	Feed	
P Non Alloyed Low Alloyed High Alloyed	1	C35, Ck45, 1020, 1045, 1060, 28Mn6	125 HB	0.50	3.50	0.19	0.40	1.26	2.50	0.32	
			190 HB				0.36			0.30	
			250 HB				1.05			0.28	
	2	42CrMo4, S150, Ck60, 4140, 4340, 100Cr6	180 HB	0.50	3.50	0.19	0.36	0.84	2.50	0.27	
			230 HB							0.16	0.32
			280 HB			2.80	0.16	0.32	0.84		
			350 HB							2.10	0.16
	3	X40CrMoV5, H13, M42, D3, S6-5-2, 12Ni19	220 HB	0.50	2.80	0.16	0.32	0.84	2.10	0.26	
			280 HB								
			320 HB								
			350 HB								
	M Austenitic Duplex Ferritic & Martensitic	4	304, 316, X5CrNi18-9	180 HB	0.50	3.50	0.18	0.32	0.84	2.50	0.21
240 HB				0.70					0.19		
5		X2CrNiN23-4, S31500	290 HB	0.50	2.80	0.16	0.28	0.56	2.10	0.20	
			310 HB								
6	410, X6Cr17, 17-4PH, 430	200 HB	0.50	3.50	0.16	0.32	0.49	2.10	0.17		
		42 HRc		2.80				1.80			
K Grey Malleable & Nodular	7	GG20, GG40, EN-GJL-250, N030B	150 HB	0.50	3.50	0.14	0.48	1.40	2.50	0.30	
			200 HB				0.44				1.26
			250 HB								
	8	GGG40, GGG70, 50005	150 HB	0.50	3.50	0.14	0.40	1.05	2.50	0.26	
200 HB			0.91								
250 HB			0.84								
S Fe, Ni & Co based Ti based	9	Incoloy 800	0.50	2.10	0.18	0.28	0.49	1.60	0.24		
		Inconel 700									
		Stellite 21									
	10	T40	0.50	2.50	0.18	0.32	0.56	1.60	0.28		
TiAl6V4		2.10								0.28	0.49
H Steel Chilled Cast Iron White Cast Iron	11	X100 CrMo13, 440C, G-X260NiCr42	45 HRc	0.50	1.80	0.10	0.24	0.42	1.60	0.21	
			50 HRc				1.40	0.20	0.28	1.20	0.15
			55 HRc				1.10	0.16	0.21	0.80	
			Ni-Hard 2				400 HB	1.40	0.20	0.28	
			G-X300CrMo15				55 HRc	1.10	0.16	0.21	0.80
NF Aluminium	12	AISI12	130 HB	0.50	4.20	0.18	0.48	1.26	2.50	0.34	

The depth of cut and feed rate tables are for the geometry and corner radius specified above the table. Refer to cutting speed tables on pages 186 and 187 for recommended materials per grade.

MACHINING CONDITIONS - TURNING - DEPTH OF CUT AND FEED

CPMT 060208 NN

Material Group	Lamina Gr. N°	Material Examples	Hardness	DOC [mm]		Feed [mm/rev]		Amax [mm ²]	Suggested Starting Parameters						
				min	max	min	max		DOC	Feed					
P	Non Alloyed	C35, Ck45, 1020, 1045, 1060, 28Mn6	125 HB	0.50	2.50	0.08	0.25	0.54	1.20	0.19					
			190 HB							0.18					
			250 HB							0.17					
	Low Alloyed	2	42CrMo4, St50, Ck60, 4140, 4340, 100Cr6	180 HB	0.50	2.50	0.08	0.23	0.36	1.20	0.16				
				230 HB		2.00									
				280 HB		1.80	0.07	0.20	0.30	1.10	0.15				
				350 HB											
	High Alloyed	3	X40CrMoV5, H13, M42, D3, S6-5-2, 12Ni19	220 HB	0.50	2.00	0.07	0.20	0.36	1.00	0.15				
				280 HB											
320 HB				1.50		0.18		0.24	0.90	0.14					
350 HB															
M	Austenitic	4	304, 316, X5CrNi18-9	0.50	2.50	0.08	0.20	0.36	1.20	0.13					
								240 HB		0.30	0.11				
	Duplex	5	X2CrNiN23-4, S31500	290 HB	0.50	2.00	0.07	0.18	0.24	1.00	0.12				
				310 HB											
	Ferritic & Martensitic	6	410, X6Cr17, 17-4PH, 430	200 HB	0.50	2.50	0.07	0.20	0.21	1.00	0.10				
				42 HRc		2.00				0.90					
K	Grey	7	GG20, GG40, EN-GJL-250, N030B	0.50	2.50	0.06	0.30	0.60	1.20	0.18					
								200 HB			0.54				
								250 HB			0.28				
	Malleable & Nodular	8	GGG40, GGG70, 50005	150 HB	0.50	2.50	0.06	0.25	0.45	1.20	0.15				
				200 HB					0.39						
				250 HB					0.36						
S	Fe, Ni & Co based	9	Incoloy 800	0.50	1.50	0.08	0.18	0.21	0.80	0.14					
			Inconel 700								250 HB				
			Stellite 21								350 HB				
	Ti based	10	T40	0.50	1.80	0.08	0.20	0.24	0.80	0.17					
			TiAl6V4		-					1.50	0.18	0.21	0.15		
H	Steel	11	X100 CrMo13, 440C, G-X260NiCr42	45 HRc	0.50	1.30	0.04	0.15	0.18	0.80	0.13				
				50 HRc							1.00	0.13	0.12	0.60	0.10
				55 HRc							0.80	0.10	0.09	0.50	0.09
				Ni-Hard 2							400 HB	1.00	0.13	0.12	
				White Cast Iron							G-X300CrMo15	55 HRc	0.80	0.10	0.09
NF	Aluminium	12	AlSi12	130 HB	0.50	3.00	0.08	0.30	0.54	1.20	0.20				

The depth of cut and feed rate tables are for the geometry and corner radius specified above the table. Refer to cutting speed tables on pages 186 and 187 for recommended materials per grade.

MACHINING CONDITIONS - TURNING - DEPTH OF CUT AND FEED

CNMG 120408 NX
DNMG 150408 NX
DNMG 150608 NX

TNMG 160408 NX
TNMG 220408 NX

Material Group	Lamina Gr. N°	Material Examples	Hardness	DOC [mm]		Feed [mm/rev]		Amax [mm²]	Suggested Starting Parameters																		
				min	max	min	max		DOC	Feed																	
P Non Alloyed Low Alloyed High Alloyed	1	C35, Ck45, 1020, 1045, 1060, 28Mn6	125 HB	0.50	5.00	0.18	0.50	1.71	3.00	0.36																	
			190 HB				0.45			0.33																	
			250 HB				0.45			0.31																	
	2	42CrMo4, S150, Ck60, 4140, 4340, 100Cr6	180 HB	0.50	5.00	0.18	0.45	1.14	3.00	0.30																	
			230 HB							0.16	0.40	0.95	2.70	0.29													
			280 HB			3.50	0.40	0.95	2.70					0.29													
			350 HB							3.00	0.40	0.95	2.50		0.27												
	3	X40CrMoV5, H13, M42, D3, S6-5-2, 12Ni19	220 HB	0.50	4.00	0.16	0.40	1.14	2.50					0.29													
			280 HB							0.35	0.76	2.50	0.27														
			320 HB			3.00	0.40	0.95	2.50					0.27													
			350 HB							3.00	0.40	0.95	2.50		0.27												
	M Austenitic	4	304, 316, X5CrNi18-9	180 HB	0.50	5.00	0.18	0.40	1.14					3.00		0.24											
240 HB				0.95						3.00	0.21																
290 HB												0.50	4.00		0.16	0.35	0.76	2.50	0.23								
310 HB	0.50	5.00	0.16		0.40	0.67	2.50	0.19																			
6				410, X6Cr17, 17-4PH, 430					200 HB	0.50	4.00			0.16						0.40	0.67	2.50	0.19				
									42 HRc			2.20	2.50		0.19												
K Grey	7	GG20, GG40, EN-GJL-250, N030B	150 HB	0.50	5.00	0.13	0.60	1.90	3.00	0.33																	
			200 HB								0.55	1.71	3.00	0.33													
			250 HB												0.55	1.71	3.00	0.33									
8	GGG40, GGG70, 50005	150 HB	0.50	5.00	0.13	0.50	1.42	3.00	0.29																		
		200 HB								1.24	3.00	0.29															
		250 HB											1.14	3.00	0.29												
S Fe, Ni & Co based	9	Incoloy 800	0.50	3.00	0.18	0.35	0.67	2.00	0.27																		
		Inconel 700								0.50	3.00	0.18				0.40	0.76	2.00	0.31								
		Stellite 21											0.50	3.00	0.18					0.35	0.67	2.00	0.29				
10	T40	0.50	3.50	0.18	0.40	0.76	2.00	0.31																			
	TiAl6V4								0.50	3.00	0.18	0.35				0.67	2.00	0.29									
H Steel Chilled Cast Iron White Cast Iron	11	X100 CrMo13, 440C, G-X260NiCr42	45 HRc	0.50	1.50	0.10	0.30	0.57					2.00	0.24													
			50 HRc						2.00	0.25	0.38	1.50			0.19												
			55 HRc													2.00	0.20	0.28	1.00	0.17							
			400 HB																		2.00	0.25	0.38	1.50	0.17		
			55 HRc																							1.50	0.20
G-X300CrMo15	0.50	6.00	0.18	0.60	1.71	3.00	0.38																				
NF Aluminium								12	AISI12	130 HB	0.50	6.00	0.18	0.60	1.71												

The depth of cut and feed rate tables are for the geometry and corner radius specified above the table. Refer to cutting speed tables on pages 186 and 187 for recommended materials per grade.

MACHINING CONDITIONS - TURNING - DEPTH OF CUT AND FEED

CNMG 120408 NN
 DNMG 110408 NN
 DNMG 150408 NN

DNMG 150608 NN
 TNMG 160408 NN
 TNMG 220408 NN

Material Group	Lamina Gr. N°	Material Examples	Hardness	DOC [mm]		Feed [mm/rev]		Amax [mm ²]	Suggested Starting Parameters			
				min	max	min	max		DOC	Feed		
P	1	C35, Ck45, 1020, 1045, 1060, 28Mn6	125 HB	0.50	5.00	0.21	0.50	1.80	3.00	0.38		
			190 HB							0.35		
			250 HB							0.33		
	2	42CrMo4, S150, Ck60, 4140, 4340, 100Cr6	180 HB	0.50	5.00	0.21	0.45	1.20	3.00	0.32		
			230 HB							0.30		
			280 HB		3.50	0.18	0.40	1.00	2.70			
			350 HB									
	3	X40CrMoV5, H13, M42, D3, S6-5-2, 12Ni19	220 HB	0.50	4.00	0.18	0.40	1.20	2.50	0.30		
			280 HB									
			320 HB		3.00		0.35	0.80	2.20			
			350 HB									
	M	4	304, 316, X5CrNi18-9	180 HB	0.50	5.00	0.20	0.40	1.20	3.00	0.25	
240 HB				0.22								
5		X2CrNi23-4, S31500	290 HB	0.50	4.00	0.18	0.35	0.80	2.50	0.24		
			310 HB									
6		410, X6Cr17, 17-4PH, 430	200 HB	0.50	5.00	0.18	0.40	0.70	2.50	0.20		
			42 HRc		4.00				2.20			
K	7	GG20, GG40, EN-GJL-250, N030B	150 HB	0.50	5.00	0.15	0.60	2.00	3.00	0.35		
			200 HB					1.80				
			250 HB					0.55				
	8	GGG40, GGG70, 50005	150 HB	0.50	5.00	0.15	0.50	1.50	3.00	0.30		
			200 HB					1.30				
			250 HB					1.20				
S	9	Incoloy 800	0.50	3.00	0.20	0.35	0.70	2.00	2.00	0.28		
		Inconel 700										
		Stellite 21										
	10	T40	0.50	3.50	0.20	0.40	0.80	2.00	2.00	0.33		
		TiAl6V4		3.00						0.35	0.70	0.30
H	11	X100 CrMo13, 440C, G-X260NiCr42	45 HRc	0.50	1.50	0.11	2.50	0.30	0.60	2.00	0.25	
			50 HRc				2.00	0.25	0.40	1.50	0.20	
			55 HRc				2.00	0.20	0.30	1.00	0.18	
			Ni-Hard 2				2.00	0.25	0.40	1.50		
			400 HB				1.50	0.20	0.30	1.00		
			G-X300CrMo15								55 HRc	
NF	12	AlSi12	130 HB	0.50	6.00	0.20	0.60	1.80	3.00	0.40		

The depth of cut and feed rate tables are for the geometry and corner radius specified above the table. Refer to cutting speed tables on pages 186 and 187 for recommended materials per grade.

MACHINING CONDITIONS - TURNING - DEPTH OF CUT AND FEED

CNMG 120412 NN
DNMG 150412 NN
DNMG 150612 NN

TNMG 160412 NN
TNMG 220412 NN

Material Group	Lamina Gr. N°	Material Examples	Hardness	DOC [mm]		Feed [mm/rev]		Amax [mm²]	Suggested Starting Parameters																	
				min	max	min	max		DOC	Feed																
P Non Alloyed Low Alloyed High Alloyed	1	C35, Ck45, 1020, 1045, 1060, 28Mn6	125 HB	0.70	6.00	0.26	0.68	3.06	4.00	0.50																
			190 HB							0.46																
			250 HB							0.44																
	2	42CrMo4, S150, Ck60, 4140, 4340, 100Cr6	180 HB	0.70	6.00	0.26	0.61	2.04	4.00	0.42																
			230 HB							4.80	0.22	0.54	1.70	3.60	0.40											
			280 HB		4.20	0.22	0.54	1.70	3.60	0.40																
			350 HB								0.70	4.80	0.22	0.54	2.04	3.40	0.40									
	3	X40CrMoV5, H13, M42, D3, S6-5-2, 12Ni19	220 HB	0.70	4.80	0.22	0.54	2.04	3.40	0.40																
			280 HB								3.60	0.22	0.47	1.36	0.37											
			320 HB		0.70	4.80	0.22	0.54	2.04	3.40						0.40										
			350 HB								0.70	4.80	0.22	0.54	2.04		3.40	0.40								
	M Austenitic	4	304, 316, X5CrNi18-9	180 HB	0.70	6.00	0.25	0.54	2.04	4.00						0.33										
240 HB				0.29																						
5				X2CrNiN23-4, S31500							290 HB	0.70	4.80	0.22	0.47	1.36	3.40	0.32								
	310 HB	0.70	6.00		0.22	0.54	1.19	3.40	0.26																	
6	410, X6Cr17, 17-4PH, 430			200 HB						0.70	4.80	0.22	0.54	1.19	2.90	0.26										
		42 HRc	0.70	6.00	0.19	0.81	3.40	4.00	0.46																	
K Grey	7	GG20, GG40, EN-GJL-250, N030B								150 HB	0.70	6.00	0.19	0.74	3.06	4.00	0.46									
			200 HB	0.70	6.00	0.19	0.68	2.21	4.00	0.40																
			250 HB															0.70	6.00	0.19	0.68	2.21	4.00	0.40		
8	GGG40, GGG70, 50005	150 HB	0.70								6.00	0.19	0.68	2.55	4.00	0.40										
		200 HB		0.70	6.00	0.19	0.68	2.21	4.00	0.40																
		250 HB															0.70	6.00	0.19	0.68	2.21	4.00	0.40			
S Fe, Ni & Co based	9	Incoloy 800	0.70								3.60	0.25	0.47	1.19	2.70	0.37										
		Inconel 700		0.70	3.60	0.25	0.47	1.19	2.70	0.37																
		Stellite 21															0.70	3.60	0.25	0.47	1.19	2.70	0.37			
10	T40	0.70	4.20								0.25	0.54	1.36	2.70	0.44											
	TiAl6V4			3.60	0.47	1.19	2.70	0.40																		
	H Steel Chilled Cast Iron White Cast Iron		11	X100 CrMo13, 440C, G-X260NiCr42					45 HRc	0.70		1.80	0.14		0.41	1.02	2.70	0.33								
50 HRc		3.00			0.27	0.51	1.30	0.26																		
55 HRc		2.40							0.27		0.51			1.30					0.20							
Ni-Hard 2		400 HB																		0.70	1.80	0.14	0.41	1.02	2.70	0.33
		G-X300CrMo15																								
NF Aluminium	12	AISI12	130 HB	0.70						7.20		0.25	0.81		3.06	4.00	0.53									

The depth of cut and feed rate tables are for the geometry and corner radius specified above the table. Refer to cutting speed tables on pages 186 and 187 for recommended materials per grade.

MACHINING CONDITIONS - TURNING - DEPTH OF CUT AND FEED

CNMG 120408 NM

Material Group	Lamina Gr. N°	Material Examples	Hardness	DOC [mm]		Feed [mm/rev]		Amax [mm ²]	Suggested Starting Parameters				
				min	max	min	max		DOC	Feed			
P	Non Alloyed	C35, Ck45, 1020, 1045, 1060, 28Mn6	125 HB	0.50	5.00	0.21	0.65	2.70	3.60	0.42			
			190 HB										
			250 HB										
	Low Alloyed	2	42CrMo4, S150, Ck60, 4140, 4340, 100Cr6	180 HB	0.50	5.00	0.21	0.59	1.80	3.60	0.38		
				230 HB		4.00							
				280 HB		3.50	0.18	0.52	1.50	3.20			
				350 HB									
	High Alloyed	3	X40CrMoV5, H13, M42, D3, S6-5-2, 12Ni19	220 HB	0.50	4.00	0.18	0.52	1.80	3.00	0.36		
				280 HB		3.00							
				320 HB		3.00	0.46	1.20	3.00				
				350 HB									
	M	Austenitic	4	304, 316, X5CrNi18-9	0.50	5.00	0.20	0.52	1.80	3.60	0.30		
240 HB									1.50		0.26		
Duplex		5	X2CrNiN23-4, S31500	290 HB	0.50	4.00	0.18	0.46	1.20	3.00	0.29		
				310 HB									
Ferritic & Martensitic		6	410, X6Cr17, 17-4PH, 430	200 HB	0.50	5.00	0.18	0.52	1.05	3.00	0.24		
				42 HRc		4.00			2.60				
K	Grey	7	GG20, GG40, EN-GJL-250, N030B	0.50	5.00	0.15	0.78	3.00	3.60	0.42			
								200 HB					
								250 HB			0.72		
	Malleable & Nodular	8	GGG40, GGG70, 50005	150 HB	0.50	5.00	0.15	0.65	2.25	3.60	0.36		
				200 HB									
				250 HB					1.80				
S	Fe, Ni & Co based	9	Incoloy 800	0.50	2.10	0.24	0.46	0.84	1.70	0.35			
			Inconel 700										
			Stellite 21										
	Ti based	10	T40	0.50	2.50	0.24	0.52	0.96	1.70	0.41			
			TiAl6V4		2.10			0.46		0.84	0.38		
H	Steel	11	X100 CrMo13, 440C, G-X260NiCr42	0.50	1.80	0.13	0.39	0.72	1.70	0.31			
			45 HRc					1.40		0.33	0.48	1.30	0.25
			50 HRc					1.10		0.26	0.36	0.90	
			55 HRc										
			Chilled Cast Iron					Ni-Hard 2		400 HB	1.40	0.33	0.48
White Cast Iron	G-X300CrMo15	55 HRc	1.10	0.26	0.36	0.90	0.19						
NF	Aluminium	12	AlSi12	130 HB	0.50	4.20	0.24	0.78	2.16	2.60	0.50		

The depth of cut and feed rate tables are for the geometry and corner radius specified above the table. Refer to cutting speed tables on pages 186 and 187 for recommended materials per grade.

MACHINING CONDITIONS - TURNING - DEPTH OF CUT AND FEED

SNMG 120408 NX

Material Group	Lamina Gr. N°	Material Examples	Hardness	DOC [mm]		Feed [mm/rev]		Amax [mm²]	Suggested Starting Parameters				
				min	max	min	max		DOC	Feed			
P	Non Alloyed	C35, Ck45, 1020, 1045, 1060, 28Mn6	125 HB	0.50	5.00	0.26	0.70	2.41	3.00	0.51			
			190 HB							0.47			
			250 HB							0.45			
	Low Alloyed	2	42CrMo4, St50, Ck60, 4140, 4340, 100Cr6	180 HB	0.50	5.00	0.26	0.63	1.61	3.00	0.43		
				230 HB							4.00	0.22	0.56
				280 HB		3.50	0.22	0.56	1.34	2.70	0.41		
				350 HB								0.41	
	High Alloyed	3	X40CrMoV5, H13, M42, D3, S6-5-2, 12Ni19	220 HB	0.50	4.00	0.22	0.56	1.61	2.50	0.41		
				280 HB								3.00	0.49
				320 HB		3.00		0.49	1.07	2.20	0.38		
				350 HB								0.38	
	M	Austenitic	4	304, 316, X5CrNi18-9	0.50	5.00	0.25	0.56	1.61	3.00	0.34		
1.34									0.30				
Duplex		5	X2CrNiN23-4, S31500	290 HB	0.50	4.00	0.22	0.49	1.07	2.50	0.32		
				310 HB									
Ferritic & Martensitic		6	410, X6Cr17, 17-4PH, 430	200 HB	0.50	5.00	0.22	0.56	0.94	2.50	0.27		
				42 HRc		4.00				2.20			
K	Grey	7	GG20, GG40, EN-GJL-250, N030B	0.50	5.00	0.18	0.84	2.68	3.00	0.47			
								200 HB			0.77	2.41	
								250 HB					
	Malleable & Nodular	8	GGG40, GGG70, 50005	150 HB	0.50	5.00	0.18	0.70	2.01	3.00	0.41		
				200 HB					1.74				
				250 HB					1.61				
S	Fe, Ni & Co based	9	Incoloy 800	0.50	3.00	0.25	0.49	0.94	2.00	0.38			
			Inconel 700										
			Stellite 21										
	Ti based	10	T40	0.50	3.50	0.25	0.56	1.07	2.00	0.45			
TiAl6V4			3.00		0.49		0.94	0.41					
H	Steel	11	X100 CrMo13, 440C, G-X260NiCr42	0.50	1.50	0.14	0.28	0.40	2.00	0.34			
									45 HRc	2.50	0.80	1.50	0.27
									50 HRc	2.00	0.35	0.54	1.00
	55 HRc	2.00	0.35	0.54	1.50								
	Chilled Cast Iron	Ni-Hard 2	400 HB	2.00	0.35	0.54	1.50	1.00	0.20				
White Cast Iron	G-X300CrMo15	55 HRc	1.50	0.28	0.40	1.00	0.20						
NF	Aluminium	12	AISI12	0.50	6.00	0.25	0.84	2.41	3.00	0.54			

The depth of cut and feed rate tables are for the geometry and corner radius specified above the table. Refer to cutting speed tables on pages 186 and 187 for recommended materials per grade.

MACHINING CONDITIONS - TURNING - DEPTH OF CUT AND FEED

SNMG 120408 NN

Material Group	Lamina Gr. N°	Material Examples	Hardness	DOC [mm]		Feed [mm/rev]		Amax [mm ²]	Suggested Starting Parameters						
				min	max	min	max		DOC	Feed					
P	Non Alloyed	C35, Ck45, 1020, 1045, 1060, 28Mn6	125 HB	0.50	5.00	0.30	0.70	2.54	3.00	0.54					
			190 HB							0.50					
			250 HB							0.47					
	Low Alloyed	2	42CrMo4, S150, Ck60, 4140, 4340, 100Cr6	180 HB	0.50	5.00	0.30	0.63	1.69	3.00	0.45				
				230 HB							4.00				
				280 HB		3.50	0.25	0.56	1.41	2.70	0.43				
				350 HB											
	High Alloyed	3	X40CrMoV5, H13, M42, D3, S6-5-2, 12Ni19	220 HB	0.50	4.00	0.25	0.56	1.69	2.50	0.43				
				280 HB								3.00	0.49	1.13	2.20
				320 HB		3.00		0.49	1.13	2.20	0.40				
				350 HB											
	M	Austenitic	4	304, 316, X5CrNi18-9	0.50	5.00	0.28	0.56	1.69	3.00	0.36				
240 HB				1.41							0.31				
Duplex		5	X2CrNiN23-4, S31500	290 HB	0.50	4.00	0.25	0.49	1.13	2.50	0.34				
				310 HB											
Ferritic & Martensitic		6	410, X6Cr17, 17-4PH, 430	200 HB	0.50	5.00	0.25	0.56	0.99	2.50	0.28				
				42 HRc								4.00	2.20		
K	Grey	7	GG20, GG40, EN-GJL-250, N030B	0.50	5.00	0.21	0.84	2.82	3.00	0.50					
			200 HB								0.77	2.54			
			250 HB												
	Malleable & Nodular	8	GGG40, GGG70, 50005	150 HB	0.50	5.00	0.21	0.70	2.12	3.00	0.43				
				200 HB								1.83			
				250 HB									1.69		
S	Fe, Ni & Co based	9	Incoloy 800	0.50	3.00	0.28	0.49	0.99	2.00	0.40					
			Inconel 700								250 HB				
			Stellite 21									350 HB			
	Ti based	10	T40	0.50	3.50	0.28	0.56	1.13	2.00	0.47					
			TiAl6V4								3.00	0.49	0.99	0.43	
H	Steel	11	X100 CrMo13, 440C, G-X260NiCr42	0.50	1.50	0.16	0.42	0.85	2.00	0.36					
			45 HRc								2.00	0.35	0.56	1.50	0.28
			50 HRc												
	Chilled Cast Iron White Cast Iron	11	Ni-Hard 2	400 HB	0.50	1.50	0.16	0.28	0.42	1.00	0.26				
				55 HRc											
				G-X300CrMo15								400 HB			
NF	Aluminium	12	AlSi12	130 HB	0.50	6.00	0.28	0.84	2.54	3.00	0.57				

The depth of cut and feed rate tables are for the geometry and corner radius specified above the table. Refer to cutting speed tables on pages 186 and 187 for recommended materials per grade.

MACHINING CONDITIONS - TURNING - DEPTH OF CUT AND FEED

SNMG 120412 NN

Material Group	Lamina Gr. N°	Material Examples	Hardness	DOC [mm]		Feed [mm/rev]		Amax [mm²]	Suggested Starting Parameters			
				min	max	min	max		DOC	Feed		
P	Non Alloyed	C35, Ck45, 1020, 1045, 1060, 28Mn6	125 HB	0.70	6.00	0.37	0.95	3.96	4.00	0.71		
			190 HB							0.65		
			250 HB							0.61		
	Low Alloyed	2	42CrMo4, St50, Ck60, 4140, 4340, 100Cr6	180 HB	0.70	6.00	0.37	0.86	2.64	4.00	0.60	
				230 HB							4.80	0.32
				280 HB		4.20	0.32	0.76	2.20	3.60	0.56	
				350 HB								0.56
	High Alloyed	3	X40CrMoV5, H13, M42, D3, S6-5-2, 12Ni19	220 HB	0.70	4.80	0.32	0.76	2.64	3.40	0.56	
				280 HB								3.60
				320 HB		3.60		0.67	1.76	2.90	0.52	
				350 HB								0.52
	M	Austenitic	4	304, 316, X5CrNi18-9	180 HB	0.70	6.00	0.35	0.76	2.64	4.00	0.47
240 HB					2.20					0.41		
Duplex		5	X2CrNiN23-4, S31500	290 HB	0.70	4.80	0.32	0.67	1.76	3.40	0.45	
				310 HB								
Ferritic & Martensitic		6	410, X6Cr17, 17-4PH, 430	200 HB	0.70	6.00	0.32	0.76	1.54	3.40	0.37	
				42 HRc		4.80				2.90		
K	Grey	7	GG20, GG40, EN-GJL-250, N030B	150 HB	0.70	6.00	0.26	1.14	4.40	4.00	0.65	
				200 HB				1.05	3.96			
				250 HB					3.30			
	Malleable & Nodular	8	GGG40, GGG70, 50005	150 HB	0.70	6.00	0.26	0.95	3.30	4.00	0.56	
200 HB				2.86								
250 HB				2.64								
S	Fe, Ni & Co based	9	Incoloy 800	0.70	3.60	0.35	0.67	1.54	2.70	0.52		
			Inconel 700									
			Stellite 21									
	Ti based	10	T40	0.70	4.20	0.35	0.76	1.76	2.70	0.61		
TiAl6V4			3.60		0.67		1.54	0.56				
H	Steel	11	X100 CrMo13, 440C, G-X260NiCr42	45 HRc	0.70	1.80	0.19	3.00	0.57	1.32	2.70	0.47
				50 HRc				2.40	0.48	0.88	2.00	0.37
				55 HRc				1.80	0.38	0.66	1.30	0.33
	Chilled Cast Iron	Ni-Hard 2	400 HB	0.70	2.40	0.38	0.48	0.88	2.00	0.28		
			55 HRc		1.80		0.38	0.66	1.30			
NF	Aluminium	12	AlSi12	0.70	7.20	0.35	1.14	3.96	4.00	0.74		

The depth of cut and feed rate tables are for the geometry and corner radius specified above the table. Refer to cutting speed tables on pages 186 and 187 for recommended materials per grade.

MACHINING CONDITIONS - TURNING - DEPTH OF CUT AND FEED

VNMG 160408 NN

Material Group	Lamina Gr. N°	Material Examples	Hardness	DOC [mm]		Feed [mm/rev]		Amax [mm ²]	Suggested Starting Parameters						
				min	max	min	max		DOC	Feed					
P	Non Alloyed	C35, Ck45, 1020, 1045, 1060, 28Mn6	125 HB	0.70	3.50	0.25	0.65	2.16	2.60	0.48					
			190 HB							0.44					
			250 HB							0.41					
	Low Alloyed	2	42CrMo4, S150, Ck60, 4140, 4340, 100Cr6	180 HB	0.70	3.50	0.25	0.59	1.44	2.60	0.40				
				230 HB		2.80									
				280 HB		2.50	0.22	0.52	1.20	2.30	0.38				
				350 HB											
	High Alloyed	3	X40CrMoV5, H13, M42, D3, S6-5-2, 12Ni19	220 HB	0.70	2.80	0.22	0.52	1.44	2.10	0.38				
				280 HB											
320 HB				2.10		0.46		0.96	1.90	0.35					
350 HB															
M	Austenitic	4	304, 316, X5CrNi18-9	0.70	3.50	0.24	0.52	1.44	2.60	0.31					
								240 HB		1.20	0.28				
	Duplex	5	X2CrNiN23-4, S31500	290 HB	0.70	2.80	0.22	0.46	0.96	2.10	0.30				
				310 HB											
	Ferritic & Martensitic	6	410, X6Cr17, 17-4PH, 430	200 HB	0.70	3.50	0.22	0.52	0.84	2.10	0.25				
				42 HRc		2.80				1.90					
K	Grey	7	GG20, GG40, EN-GJL-250, N030B	0.70	3.50	0.18	0.78	2.40	2.60	0.44					
								200 HB			2.16				
								250 HB							
	Malleable & Nodular	8	GGG40, GGG70, 50005	150 HB	0.70	3.50	0.18	0.65	1.80	2.60	0.38				
				200 HB					1.56						
				250 HB					1.44						
S	Fe, Ni & Co based	9	Incoloy 800	0.70	2.10	0.24	0.46	0.84	1.70	0.35					
			Inconel 700								250 HB				
			Stellite 21								350 HB				
	Ti based	10	T40	0.70	2.50	0.24	0.52	0.96	1.70	0.41					
			TiAl6V4		2.10					0.46	0.84	0.38			
H	Steel	11	X100 CrMo13, 440C, G-X260NiCr42	0.70	1.80	0.13	0.39	0.72	1.70	0.31					
										50 HRc	1.40	0.33	0.48	1.30	0.25
										55 HRc	1.10	0.26	0.36	0.90	0.23
										Ni-Hard 2	400 HB	1.40	0.33	0.48	
										White Cast Iron	G-X300CrMo15	55 HRc	1.10	0.26	0.36
NF	Aluminium	12	AlSi12	130 HB	0.70	4.20	0.24	0.78	2.16	2.60	0.50				

The depth of cut and feed rate tables are for the geometry and corner radius specified above the table. Refer to cutting speed tables on pages 186 and 187 for recommended materials per grade.

MACHINING CONDITIONS - TURNING - DEPTH OF CUT AND FEED

WNMG 060408 NX
WNMG 080408 NX

Material Group	Lamina Gr. N°	Material Examples	Hardness	DOC [mm]		Feed [mm/rev]		Amax [mm²]	Suggested Starting Parameters					
				min	max	min	max		DOC	Feed				
P Non Alloyed Low Alloyed High Alloyed	1	C35, Ck45, 1020, 1045, 1060, 28Mn6	125 HB	0.50	2.50	0.18	0.50	1.13	1.80	0.36				
			190 HB				0.45			0.33				
			250 HB				0.95			0.31				
	2	42CrMo4, St50, Ck60, 4140, 4340, 100Cr6	180 HB	0.50	2.50	0.18	0.45	0.76	1.80	0.30				
			230 HB								0.16	0.40	0.63	1.60
			280 HB			1.80	0.40	0.63	1.60					
			350 HB							1.80	0.40	0.63	1.60	
	3	X40CrMoV5, H13, M42, D3, S6-5-2, 12Ni19	220 HB	0.50	2.00	0.16	0.40	0.76	1.50					0.29
			280 HB							1.50	0.16	0.35	0.50	
			320 HB		1.50	0.16	0.35	0.50	1.30					
			350 HB							1.50	0.16	0.35	0.50	1.30
	M Austenitic	4	304, 316, X5CrNi18-9	180 HB	0.50	2.50	0.18	0.40	0.76					
240 HB				0.63					0.21					
290 HB				0.50					2.00	0.16	0.35	0.50	1.50	0.23
310 HB														
Ferritic & Martensitic	6	410, X6Cr17, 17-4PH, 430	200 HB	0.50	2.50	0.16	0.40	0.44	1.50	0.19				
			42 HRc		2.00				1.30					
K Grey Malleable & Nodular	7	GG20, GG40, EN-GJL-250, N030B	150 HB	0.50	2.50	0.13	0.60	1.26	1.80	0.33				
			200 HB					0.55			1.13			
			250 HB											
8	GGG40, GGG70, 50005	150 HB	0.50	2.50	0.13	0.50	0.95	1.80	0.29					
		200 HB					0.82							
		250 HB					0.76							
S Fe, Ni & Co based Ti based	9	Incoloy 800	240 HB	0.50	1.50	0.18	0.35	0.44	1.20	0.27				
		Inconel 700	250 HB											
		Stellite 21	350 HB											
10	T40	-	0.50	1.80	0.18	0.40	0.50	1.20	0.31					
		TiAl6V4		-					1.50	0.35	0.44	0.29		
H Steel Chilled Cast Iron White Cast Iron	11	X100 CrMo13, 440C, G-X260NiCr42	45 HRc	0.50	1.30	0.10	0.30	0.38	1.20	0.24				
			50 HRc							1.00	0.25	0.25	0.90	0.19
			55 HRc							0.80	0.20	0.19	0.60	0.17
			Ni-Hard 2							400 HB	1.00	0.25	0.25	
			G-X300CrMo15							55 HRc	0.80	0.20	0.19	0.60
NF Aluminium	12	AlSi12	130 HB	0.50	3.00	0.18	0.60	1.13	1.80	0.38				

The depth of cut and feed rate tables are for the geometry and corner radius specified above the table. Refer to cutting speed tables on pages 186 and 187 for recommended materials per grade.

MACHINING CONDITIONS - TURNING - DEPTH OF CUT AND FEED

WNMG 060408 NN

WNMG 080408 NN

Material Group	Lamina Gr. N°	Material Examples	Hardness	DOC [mm]		Feed [mm/rev]		Amax [mm ²]	Suggested Starting Parameters					
				min	max	min	max		DOC	Feed				
P	Non Alloyed	C35, Ck45, 1020, 1045, 1060, 28Mn6	125 HB	0.50	2.50	0.21	0.50	1.17	1.80	0.38				
			190 HB							0.35				
			250 HB							0.33				
	Low Alloyed	2	42CrMo4, S150, Ck60, 4140, 4340, 100Cr6	180 HB	0.50	2.50	0.21	0.45	0.78	1.80	0.32			
				230 HB		2.00								
				280 HB		1.80	0.18	0.40	0.65	1.60	0.30			
				350 HB										
	High Alloyed	3	X40CrMoV5, H13, M42, D3, S6-5-2, 12Ni19	220 HB	0.50	2.00	0.18	0.40	0.78	1.50	0.30			
				280 HB										
				320 HB		1.50		0.35	0.52	1.30	0.28			
				350 HB										
	M	Austenitic	4	304, 316, X5CrNi18-9	0.50	2.50	0.20	0.40	0.78	1.80	0.25			
240 HB											0.22			
Duplex		5	X2CrNiN23-4, S31500	290 HB	0.50	2.00	0.18	0.35	0.52	1.50	0.24			
				310 HB										
Ferritic & Martensitic		6	410, X6Cr17, 17-4PH, 430	200 HB	0.50	2.50	0.18	0.40	0.46	1.50	0.20			
				42 HRc		2.00				1.30				
K	Grey	7	GG20, GG40, EN-GJL-250, N030B	0.50	2.50	0.15	0.60	1.30	1.80	0.35				
								200 HB						
								250 HB			0.55			
	Malleable & Nodular	8	GGG40, GGG70, 50005	150 HB	0.50	2.50	0.15	0.50	0.98	1.80	0.30			
				200 HB					0.85					
				250 HB					0.78					
S	Fe, Ni & Co based	9	Incoloy 800	0.50	1.50	0.20	0.35	0.46	1.20	0.28				
			Inconel 700											
			Stellite 21											
	Ti based	10	T40	0.50	1.80	0.20	0.40	0.52	1.20	0.33				
			TiAl6V4		1.50					0.35	0.46	0.30		
H	Steel	11	X100 CrMo13, 440C, G-X260NiCr42	0.50	1.30	0.11	0.30	0.39	1.20	0.25				
			45 HRc							1.00	0.25	0.26	0.90	0.20
			50 HRc							0.80	0.20	0.20	0.60	0.18
	55 HRc	1.00	0.25	0.26	0.90									
	Chilled Cast Iron	Ni-Hard 2	400 HB	0.50	1.00	0.11	0.20	0.20	0.60	0.15				
			55 HRc											
White Cast Iron	G-X300CrMo15	400 HB	0.50	1.00	0.11	0.20	0.20	0.60	0.15					
		55 HRc												
NF	Aluminium	12	AlSi12	0.50	3.00	0.20	0.60	1.17	1.80	0.40				

The depth of cut and feed rate tables are for the geometry and corner radius specified above the table. Refer to cutting speed tables on pages 186 and 187 for recommended materials per grade.

MACHINING CONDITIONS - TURNING - DEPTH OF CUT AND FEED

WNMG 080412 NN

Material Group	Lamina Gr. N°	Material Examples	Hardness	DOC [mm]		Feed [mm/rev]		Amax [mm²]	Suggested Starting Parameters					
				min	max	min	max		DOC	Feed				
P Non Alloyed Low Alloyed High Alloyed	1	C35, Ck45, 1020, 1045, 1060, 28Mn6	125 HB	0.70	3.50	0.25	0.65	2.16	2.60	0.48				
			190 HB							0.44				
			250 HB							0.41				
	2	42CrMo4, St50, Ck60, 4140, 4340, 100Cr6	180 HB	0.70	3.50	0.25	0.59	1.44	2.60	0.40				
			230 HB							2.80	0.22	0.52	1.20	2.30
			280 HB		350 HB	2.50	0.22	0.52	1.20					
			350 HB							2.20 HB	2.80	0.22	0.52	1.44
	3	X40CrMoV5, H13, M42, D3, S6-5-2, 12Ni19	280 HB	0.70	2.80	0.22	0.46	0.96	1.90					
			320 HB							2.10	0.22	0.46	0.96	1.90
			350 HB		220 HB	2.80	0.22	0.52	1.44					
			350 HB							280 HB	2.80	0.22	0.52	1.44
	M Austenitic	4	304, 316, X5CrNi18-9	180 HB	0.70	3.50	0.24	0.52	1.44					
240 HB				1.20						2.60	0.28			
290 HB												0.96	2.10	0.30
Duplex	5	X2CrNiN23-4, S31500	310 HB	0.70	2.80	0.22	0.46	0.96	2.10	0.30				
			290 HB											
Ferritic & Martensitic	6	410, X6Cr17, 17-4PH, 430	200 HB	0.70	3.50	0.22	0.52	0.84	2.10	0.25				
			42 HRc								2.80	0.22	0.52	0.84
K Grey	7	GG20, GG40, EN-GJL-250, N030B	150 HB	0.70	3.50	0.18	0.78	2.40	2.60	0.44				
			200 HB								0.72	2.16		
			250 HB											
Malleable & Nodular	8	GGG40, GGG70, 50005	150 HB	0.70	3.50	0.18	0.65	1.80	2.60	0.38				
			200 HB								1.56			
			250 HB									1.44		
S Fe, Ni & Co based	9	Incoloy 800	240 HB	0.70	2.10	0.24	0.46	0.84	1.70	0.35				
		Inconel 700	250 HB											
		Stellite 21	350 HB											
Ti based	10	T40	-	0.70	2.50	0.24	0.52	0.96	1.70	0.41				
		TiAl6V4	-							2.10	0.24	0.46	0.84	1.70
H Steel Chilled Cast Iron White Cast Iron	11	X100 CrMo13, 440C, G-X260NiCr42	45 HRc	0.70	1.80	0.13	0.39	0.72	1.70					
			50 HRc							1.40	0.33	0.48	1.30	0.25
			55 HRc											
			400 HB							1.40	0.33	0.48	1.30	0.23
55 HRc	1.10	0.26	0.36	0.90	0.19									
NF Aluminium						12	AISI12	130 HB	0.70	4.20	0.24	0.78	2.16	2.60

The depth of cut and feed rate tables are for the geometry and corner radius specified above the table. Refer to cutting speed tables on pages 186 and 187 for recommended materials per grade.

MACHINING CONDITIONS - TURNING - DEPTH OF CUT AND FEED

WNMG 080408 NM

Material Group	Lamina Gr. N°	Material Examples	Hardness	DOC [mm]		Feed [mm/rev]		Amax [mm ²]	Suggested Starting Parameters						
				min	max	min	max		DOC	Feed					
P	Non Alloyed	C35, Ck45, 1020, 1045, 1060, 28Mn6	125 HB	0.50	3.50	0.25	0.65	2.16	2.60	0.48					
			190 HB							0.44					
			250 HB							0.41					
	Low Alloyed	2	42CrMo4, S150, Ck60, 4140, 4340, 100Cr6	180 HB	0.50	3.50	0.25	0.59	1.44	2.60	0.40				
				230 HB		2.80									
				280 HB		2.50	0.22	0.52	1.20	2.30	0.38				
				350 HB											
	High Alloyed	3	X40CrMoV5, H13, M42, D3, S6-5-2, 12Ni19	220 HB	0.50	2.80	0.22	0.52	1.44	2.10	0.38				
				280 HB											
				320 HB		2.10		0.46	0.96	1.90	0.35				
				350 HB											
	M	Austenitic	4	304, 316, X5CrNi18-9	0.50	3.50	0.24	0.52	1.44	2.60	0.31				
1.20									0.28						
Duplex		5	X2CrNiN23-4, S31500	290 HB	0.50	2.80	0.22	0.46	0.96	2.10	0.30				
				310 HB											
Ferritic & Martensitic		6	410, X6Cr17, 17-4PH, 430	200 HB	0.50	3.50	0.22	0.52	0.84	2.10	0.25				
				42 HRc		2.80				1.90					
K	Grey	7	GG20, GG40, EN-GJL-250, N030B	0.50	3.50	0.18	0.78	2.40	2.60	0.44					
								200 HB			2.16				
								250 HB							
	Malleable & Nodular	8	GGG40, GGG70, 50005	150 HB	0.50	3.50	0.18	0.65	1.80	2.60	0.38				
				200 HB					1.56						
				250 HB					1.44						
S	Fe, Ni & Co based	9	Incoloy 800	0.50	2.10	0.24	0.46	0.84	1.70	0.35					
			Inconel 700								250 HB				
			Stellite 21								350 HB				
	Ti based	10	T40	0.50	2.50	0.24	0.52	0.96	1.70	0.41					
			TiAl6V4		2.10					0.46	0.84	0.38			
			-		-										
H	Steel	11	X100 CrMo13, 440C, G-X260NiCr42	0.50	1.80	0.13	0.39	0.72	1.70	0.31					
										50 HRc	1.40	0.33	0.48	1.30	0.25
										55 HRc	1.10	0.26	0.36	0.90	0.23
	Chilled Cast Iron	Ni-Hard 2	400 HB	1.40	0.33	0.48	1.30								
			White Cast Iron					G-X300CrMo15	55 HRc	1.10	0.26	0.36	0.90	0.19	
	NF	Aluminium		12	AlSi12	130 HB	0.50		4.20	0.24	0.78	2.16	2.60	0.50	

The depth of cut and feed rate tables are for the geometry and corner radius specified above the table. Refer to cutting speed tables on pages 186 and 187 for recommended materials per grade.

MACHINING CONDITIONS - TURNING - DEPTH OF CUT AND FEED

CNMM 120408 NR

Material Group	Lamina Gr. N°	Material Examples	Hardness	DOC [mm]		Feed [mm/rev]		Amax [mm²]	Suggested Starting Parameters					
				min	max	min	max		DOC	Feed				
P Non Alloyed Low Alloyed High Alloyed	1	C35, Ck45, 1020, 1045, 1060, 28Mn6	125 HB	0.50	7.00	0.21	0.60	2.88	4.20	0.46				
			190 HB							0.42				
			250 HB							0.40				
	2	42CrMo4, St50, Ck60, 4140, 4340, 100Cr6	180 HB	0.50	7.00	0.21	0.54	1.92	4.20	0.38				
			230 HB							5.60	0.18	0.48	1.60	3.80
			280 HB		4.90	0.18	0.48	1.60	3.80					
			350 HB							4.90	0.18	0.48	1.60	3.80
	3	X40CrMoV5, H13, M42, D3, S6-5-2, 12Ni19	220 HB	0.50	5.60	0.18	0.48	1.92	3.50					
			280 HB							4.20	0.42	1.28	3.10	0.34
			320 HB		4.20		0.42	1.28	3.10					
			350 HB							4.20	0.42	1.28	3.10	0.34
	M Austenitic	4	304, 316, X5CrNi18-9	180 HB	0.50	7.00	0.20	0.48	1.92					
240 HB				1.60						0.26				
Duplex									5		X2CrNiN23-4, S31500	290 HB	0.50	5.60
	310 HB													
Ferritic & Martensitic	6	410, X6Cr17, 17-4PH, 430	200 HB	0.50	7.00	0.18	0.48	1.12	3.50	0.24				
			42 HRc		5.60				3.10					
K Grey Malleable & Nodular	7	GG20, GG40, EN-GJL-250, N030B	150 HB	0.50	7.00	0.15	0.72	3.20	4.20	0.42				
			200 HB					0.66			2.88			
			250 HB				0.50				7.00	0.15	0.60	2.40
200 HB	2.08													
250 HB	1.92													
S Fe, Ni & Co based Ti based	9	Incoloy 800	240 HB	0.50	4.20	0.20	0.42	1.12	2.80	0.34				
		Inconel 700	250 HB											
		Stellite 21	350 HB											
	10	T40	-	0.50	4.90	0.20	0.48	1.28	2.80	0.40				
TiAl6V4		-	4.20		0.42			1.12			2.80	0.36		
H Steel Chilled Cast Iron White Cast Iron	11	X100 CrMo13, 440C, G-X260NiCr42	45 HRc	0.50	2.10	0.11	0.36	0.96	2.80	0.30				
			50 HRc					2.80			0.64			
			55 HRc					2.80			0.48	1.40		
			Ni-Hard 2					400 HB			2.80	0.30	0.64	2.10
								400 HB				0.30	0.64	2.10
G-X300CrMo15	55 HRc	2.10	0.24	0.48	1.40	0.18								
NF Aluminium	12	AlSi12	130 HB	0.50	8.40	0.20	0.72	2.88	4.20	0.48				

The depth of cut and feed rate tables are for the geometry and corner radius specified above the table. Refer to cutting speed tables on pages 186 and 187 for recommended materials per grade.

MACHINING CONDITIONS - TURNING - DEPTH OF CUT AND FEED

CNMM 120412 NR

Material Group	Lamina Gr. N°	Material Examples	Hardness	DOC [mm]		Feed [mm/rev]		Amax [mm ²]	Suggested Starting Parameters							
				min	max	min	max		DOC	Feed						
P	Non Alloyed	C35, Ck45, 1020, 1045, 1060, 28Mn6	125 HB	0.70	7.00	0.21	0.60	3.24	5.00	0.46						
			190 HB							0.42						
			250 HB							0.40						
	Low Alloyed	2	42CrMo4, S150, Ck60, 4140, 4340, 100Cr6	180 HB	0.70	7.00	0.21	0.54	2.16	5.00	0.38					
				230 HB		5.60										
				280 HB		4.90	0.18	0.48	1.80	4.50	0.36					
				350 HB												
	High Alloyed	3	X40CrMoV5, H13, M42, D3, S6-5-2, 12Ni19	220 HB	0.70	5.60	0.18	0.48	2.16	4.10	0.36					
				280 HB												
320 HB				4.20		0.42		1.44	3.60	0.34						
350 HB																
M	Austenitic	4	304, 316, X5CrNi18-9	0.70	7.00	0.20	0.48	2.16	5.00	0.30						
								180 HB		1.80	0.26					
	Duplex	5	X2CrNiN23-4, S31500	290 HB	0.70	5.60	0.18	0.42	1.44	4.10	0.29					
				310 HB												
	Ferritic & Martensitic	6	410, X6Cr17, 17-4PH, 430	200 HB	0.70	7.00	0.18	0.48	1.26	4.10	0.24					
				42 HRc		5.60				3.60						
K	Grey	7	GG20, GG40, EN-GJL-250, N030B	0.70	7.00	0.15	0.72	3.60	5.00	0.42						
								200 HB			0.66	3.24				
								250 HB								
	Malleable & Nodular	8	GGG40, GGG70, 50005	150 HB	0.70	7.00	0.15	0.60	2.70	5.00	0.36					
				200 HB					2.34							
				250 HB					2.16							
S	Fe, Ni & Co based	9	Incoloy 800	0.70	4.20	0.20	0.42	1.26	3.30	0.34						
			Inconel 700								250 HB					
			Stellite 21								350 HB					
	Ti based	10	T40	0.70	4.90	0.20	0.48	1.44	3.30	0.40						
			TiAl6V4		4.20					0.42	1.26	0.36				
H	Steel	11	X100 CrMo13, 440C, G-X260NiCr42	0.70	2.10	0.11	0.24	0.54	1.70	0.22						
											45 HRc	3.50	0.36	1.08	3.30	0.30
											50 HRc	2.80	0.30	0.72	2.50	0.24
											55 HRc	2.10	0.24	0.54	1.70	0.22
											400 HB	2.80	0.30	0.72	2.50	0.22
Chilled Cast Iron	White Cast Iron	11	Ni-Hard 2	0.70	2.10	0.11	0.24	0.54	1.70	0.18						
											400 HB	2.80	0.30	0.72	2.50	0.22
NF	Aluminium	12	AlSi12	0.70	8.40	0.20	0.72	3.24	5.00	0.48						
											130 HB					

The depth of cut and feed rate tables are for the geometry and corner radius specified above the table. Refer to cutting speed tables on pages 186 and 187 for recommended materials per grade.

MACHINING CONDITIONS - TURNING - DEPTH OF CUT AND FEED

CNMP 120408 NN
TNMP 160408 NN

Material Group	Lamina Gr. N°	Material Examples	Hardness	DOC [mm]		Feed [mm/rev]		Amax [mm²]	Suggested Starting Parameters				
				min	max	min	max		DOC	Feed			
P Non Alloyed Low Alloyed High Alloyed	1	C35, Ck45, 1020, 1045, 1060, 28Mn6	125 HB	0.50	5.00	0.21	0.50	1.80	3.00	0.35			
			190 HB				0.45						
			250 HB				1.50						
	2	42CrMo4, S150, Ck60, 4140, 4340, 100Cr6	180 HB	0.50	5.00	0.21	0.45	1.20	3.00	0.32			
			230 HB								0.18	0.40	
			280 HB										
			350 HB										1.00
	3	X40CrMoV5, H13, M42, D3, S6-5-2, 12Ni19	220 HB	0.50	4.00	0.18	0.40	1.20	2.50	0.30			
			280 HB								3.00	0.35	0.80
			320 HB										
			350 HB										
	M Austenitic Duplex Ferritic & Martensitic	4	304, 316, X5CrNi18-9	180 HB	0.50	5.00	0.20	0.40	1.20	3.00	0.35		
240 HB				1.00							0.32		
5		X2CrNiN23-4, S31500	290 HB	0.50	4.00	0.18	0.35	0.80	2.50	0.28			
			310 HB										
6		410, X6Cr17, 17-4PH, 430	200 HB	0.50	5.00	0.22	0.40	1.00	3.00	0.32			
			42 HRc		4.00						2.50		
K Grey Malleable & Nodular	7	GG20, GG40, EN-GJL-250, N030B	150 HB	0.50	5.00	0.15	0.60	2.00	3.00	0.35			
			200 HB					1.80					
			250 HB										
	8	GGG40, GGG70, 50005	150 HB	0.50	5.00	0.15	0.50	1.50	3.00	0.30			
			200 HB					1.30					
			250 HB					1.20					
S Fe, Ni & Co based Ti based	9	Incoloy 800	0.50	3.00	0.20	0.35	0.70	2.00	0.28				
		Inconel 700											
		Stellite 21											
	10	T40	0.50	4.00	0.20	0.40	0.80	2.00	0.33				
TiAl6V4		3.00							0.35	0.70	0.30		
H Steel Chilled Cast Iron White Cast Iron	11	X100 CrMo13, 440C, G-X260NiCr42	45 HRc	0.50	2.50	0.11	0.30	0.60	2.00	0.25			
			50 HRc							2.00	1.50	0.20	
			55 HRc							1.50	1.00	0.20	0.30
			Ni-Hard 2							2.00	1.50	0.25	0.40
			G-X300CrMo15							1.50	1.00	0.20	0.30
NF Aluminium	12	AISI12	130 HB	0.50	6.00	0.20	0.60	1.80	3.00	0.40			

The depth of cut and feed rate tables are for the geometry and corner radius specified above the table. Refer to cutting speed tables on pages 186 and 187 for recommended materials per grade.

MACHINING CONDITIONS - TURNING - DEPTH OF CUT AND FEED

CNMP 120412 NN

Material Group	Lamina Gr. N°	Material Examples	Hardness	DOC [mm]		Feed [mm/rev]		Amax [mm ²]	Suggested Starting Parameters			
				min	max	min	max		DOC	Feed		
P	Non Alloyed	C35, Ck45, 1020, 1045, 1060, 28Mn6	125 HB	0.70	6.00	0.26	0.68	3.06	4.00	0.50		
			190 HB							0.46		
			250 HB							0.44		
	Low Alloyed	2	42CrMo4, S150, Ck60, 4140, 4340, 100Cr6	180 HB	0.70	6.00	0.26	0.61	2.04	4.00	0.42	
				230 HB		4.80						
				280 HB		4.20	0.22	0.54	1.70	3.60	0.40	
				350 HB								
	High Alloyed	3	X40CrMoV5, H13, M42, D3, S6-5-2, 12Ni19	220 HB	0.70	4.80	0.22	0.54	2.04	3.40	0.40	
				280 HB							3.60	0.47
				320 HB		0.37						
				350 HB								
	M	Austenitic	4	304, 316, X5CrNi18-9	0.70	6.00	0.25	0.54	2.04	4.00	0.33	
1.70									0.29			
Duplex		5	X2CrNiN23-4, S31500	290 HB	0.70	4.80	0.22	0.47	1.36	3.40	0.32	
				310 HB								
Ferritic & Martensitic		6	410, X6Cr17, 17-4PH, 430	200 HB	0.70	6.00	0.22	0.54	1.19	3.40	0.26	
				42 HRc		4.80				2.90		
K	Grey	7	GG20, GG40, EN-GJL-250, N030B	0.70	6.00	0.19	0.81	3.40	4.00	0.46		
								3.06				
							0.74					
	Malleable & Nodular	8	GGG40, GGG70, 50005	150 HB	0.70	6.00	0.19	0.68	2.55	4.00	0.40	
				200 HB					2.21			
				250 HB					2.04			
S	Fe, Ni & Co based	9	Incoloy 800	0.70	3.60	0.25	0.47	1.19	2.70	0.37		
			Inconel 700									
			Stellite 21									
	Ti based	10	T40	0.70	4.20	0.25	0.54	1.36	2.70	0.44		
			TiAl6V4		3.60					0.47	1.19	0.40
			-									
H	Steel	11	X100 CrMo13, 440C, G-X260NiCr42	0.70	1.80	0.14	3.00	0.41	1.02	2.70	0.33	
							50 HRc	2.40	0.34	0.68	2.00	0.26
							55 HRc	2.40	0.27	0.51	1.30	0.24
							Ni-Hard 2	400 HB	2.40	0.34	0.68	
							White Cast Iron	G-X300CrMo15	55 HRc	1.80	0.27	0.51
NF	Aluminium	12	AlSi12	130 HB	0.70	7.20	0.25	0.81	3.06	4.00	0.53	

The depth of cut and feed rate tables are for the geometry and corner radius specified above the table. Refer to cutting speed tables on pages 186 and 187 for recommended materials per grade.

MACHINING CONDITIONS - TURNING - DEPTH OF CUT AND FEED

WNMP 060408 NN
WNMP 080408 NN

Material Group	Lamina Gr. N°	Material Examples	Hardness	DOC [mm]		Feed [mm/rev]		Amax [mm²]	Suggested Starting Parameters						
				min	max	min	max		DOC	Feed					
P Non Alloyed Low Alloyed High Alloyed	1	C35, Ck45, 1020, 1045, 1060, 28Mn6	125 HB	0.50	2.50	0.21	0.50	1.17	1.80	0.38					
			190 HB							0.35					
			250 HB							0.33					
	2	42CrMo4, St50, Ck60, 4140, 4340, 100Cr6	180 HB	0.50	2.50	0.21	0.45	0.78	1.80	0.32					
			230 HB							2.00					
			280 HB		1.80	0.18	0.40	0.65	1.60	0.30					
			350 HB												
	3	X40CrMoV5, H13, M42, D3, S6-5-2, 12Ni19	220 HB	0.50	2.00	0.18	0.40	0.78	1.50	0.30					
			280 HB								1.50				
			320 HB		1.30		0.35	0.52	1.30	0.28					
			350 HB												
	M Austenitic Duplex Ferritic & Martensitic	4	304, 316, X5CrNi18-9	180 HB	0.50	2.50	0.20	0.40	1.80	0.25					
240 HB				0.22											
5		X2CrNiN23-4, S31500	290 HB	0.50	2.00	0.18	0.35	0.52	1.50	0.24					
			310 HB												
6		410, X6Cr17, 17-4PH, 430	200 HB	0.50	2.50	0.18	0.40	0.46	1.50	0.20					
			42 HRc		2.00				1.30						
K Grey Malleable & Nodular	7	GG20, GG40, EN-GJL-250, N030B	150 HB	0.50	2.50	0.15	0.60	1.30	1.80	0.35					
			200 HB					1.17							
			250 HB				0.55								
	8	GGG40, GGG70, 50005	150 HB	0.50	2.50	0.15	0.50	0.98	1.80	0.30					
			200 HB					0.85							
			250 HB					0.78							
S Fe, Ni & Co based Ti based	9	Incoloy 800	0.50	1.50	0.20	0.35	0.45	1.20	0.28						
		Inconel 700													
		Stellite 21													
	10	T40	0.50	1.80	0.20	0.40	0.52	1.20	0.33						
		TiAl6V4							1.50	0.35	0.46	0.30			
H Steel Chilled Cast Iron White Cast Iron	11	X100 CrMo13, 440C, G-X260NiCr42	45 HRc	0.50	1.30	0.11	0.30	0.39	1.20	0.25					
			50 HRc							1.00	0.25	0.26	0.90	0.20	
			55 HRc							0.80	0.20	0.20	0.60	0.18	
			Ni-Hard 2							1.00	0.25	0.26	0.90		
			G-X300CrMo15							55 HRc	0.80	0.20	0.20	0.60	0.15
NF Aluminium	12	AISI12	130 HB	0.50	3.00	0.20	0.60	1.17	1.80	0.40					

The depth of cut and feed rate tables are for the geometry and corner radius specified above the table. Refer to cutting speed tables on pages 186 and 187 for recommended materials per grade.

MACHINING CONDITIONS - TURNING - DEPTH OF CUT AND FEED

DNUX 150608 R11

Material Group	Lamina Gr. N°	Material Examples	Hardness	DOC [mm]		Feed [mm/rev]		Amax [mm ²]	Suggested Starting Parameters			
				min	max	min	max		DOC	Feed		
P	Non Alloyed	C35, Ck45, 1020, 1045, 1060, 28Mn6	125 HB	0.50	5.00	0.18	0.50	1.71	3.00	0.36		
			190 HB							0.33		
			250 HB							0.31		
	Low Alloyed	2	42CrMo4, S150, Ck60, 4140, 4340, 100Cr6	180 HB	0.50	5.00	0.18	0.45	1.14	3.00	0.30	
				230 HB		4.00						
				280 HB		3.50	0.16	0.40	0.95	2.70		
				350 HB						0.29		
	High Alloyed	3	X40CrMoV5, H13, M42, D3, S6-5-2, 12Ni19	220 HB	0.50	4.00	0.16	0.40	1.14	2.50	0.29	
				280 HB							3.00	0.35
				320 HB		0.27						
				350 HB								
	M	Austenitic	4	304, 316, X5CrNi18-9	0.50	5.00	0.18	0.40	1.14	3.00	0.24	
240 HB				0.95					0.21			
Duplex		5	X2CrNiN23-4, S31500	290 HB	0.50	4.00	0.16	0.35	0.76	2.50	0.23	
				310 HB								
Ferritic & Martensitic		6	410, X6Cr17, 17-4PH, 430	200 HB	0.50	5.00	0.16	0.40	0.67	2.50	0.19	
				42 HRc		4.00				2.20		
K	Grey	7	GG20, GG40, EN-GJL-250, N030B	0.50	5.00	0.13	0.60	1.90	3.00	0.33		
			200 HB					1.71				
			250 HB					0.55				
	Malleable & Nodular	8	GGG40, GGG70, 50005	150 HB	0.50	5.00	0.13	0.50	1.42	3.00	0.29	
				200 HB					1.24			
				250 HB					1.14			
S	Fe, Ni & Co based	9	Incoloy 800	0.50	3.00	0.18	0.35	0.67	2.00	0.27		
			Inconel 700									
			Stellite 21									
	Ti based	10	T40	0.50	3.50	0.18	0.40	0.76	2.00	0.31		
			TiAl6V4		3.00					0.35	0.67	0.29
H	Steel	11	X100 CrMo13, 440C, G-X260NiCr42	0.50	1.50	0.10	2.50	0.30	0.57	2.00	0.24	
			45 HRc				2.00	0.25	0.38	1.50	0.19	
			50 HRc				2.00	0.20	0.28	1.00	0.17	
	55 HRc	2.00	0.25				0.38	1.50				
	400 HB	2.00	0.20				0.28	1.00				
	Chilled Cast Iron	11	Ni-Hard 2				0.50	1.50	0.10	2.00	0.20	0.28
White Cast Iron	G-X300CrMo15											
NF	Aluminium	12	AlSi12	0.50	6.00	0.18	0.60	1.71	3.00	0.38		

The depth of cut and feed rate tables are for the geometry and corner radius specified above the table. Refer to cutting speed tables on pages 186 and 187 for recommended materials per grade.

MACHINING CONDITIONS - TURNING - DEPTH OF CUT AND FEED

KNUX 160405 L
KNUX 160405 R

Material Group	Lamina Gr. N°	Material Examples	Hardness	DOC [mm]		Feed [mm/rev]		Amax [mm ²]	Suggested Starting Parameters						
				min	max	min	max		DOC	Feed					
P Non Alloyed Low Alloyed High Alloyed	1	C35, Ck45, 1020, 1045, 1060, 28Mn6	125 HB	0.30	5.00	0.11	0.23	0.85	3.00	0.18					
			190 HB								4.20	0.20	0.73		
			250 HB												
	2	42CrMo4, St50, Ck60, 4140, 4340, 100Cr6	180 HB	0.30	4.20	0.10	0.20	0.71	3.00	0.14					
			230 HB												
			280 HB								3.30	0.18	0.56		
			350 HB												
	3	X40CrMoV5, H13, M42, D3, S6-5-2, 12Ni19	220 HB	0.30	4.20	0.09	0.18	0.56	2.60	0.10					
			280 HB												
			320 HB								3.30	0.14	0.45		
			350 HB												
	M Austenitic Duplex Ferritic & Martensitic	4	304, 316, X5CrNi18-9	180 HB	0.30	4.20	0.08	0.18	0.45	3.00	0.09				
240 HB															
5		X2CrNiN23-4, S31500	290 HB	0.30	3.30	0.08	0.14	0.28	2.60	0.08					
			310 HB												
6		410, X6Cr17, 17-4PH, 430	200 HB	0.30	4.20	0.08	0.18	0.45	2.60	0.09					
			42 HRc								3.30	0.16	0.37		
K Grey Malleable & Nodular	7	GG20, GG40, EN-GJL-250, N030B	150 HB	0.30	5.00	0.08	0.20	0.90	3.00	0.18					
			200 HB												
			250 HB												
	8	GGG40, GGG70, 50005	150 HB	0.30	4.20	0.08	0.18	0.68	3.00	0.13					
			200 HB												
			250 HB												
S Fe, Ni & Co based Ti based	9	Incoloy 800	0.30	3.30	0.09	0.15	0.37	2.00	0.10						
		Inconel 700													
		Stellite 21													
	10	T40	0.30	3.30	0.09	0.16	0.45	2.00	0.14						
		TiAl6V4								-	0.14	0.37			
H Steel Chilled Cast Iron White Cast Iron	11	X100 CrMo13, 440C, G-X260NiCr42	45 HRc	0.30	3.00	0.05	0.12	0.28	2.10	0.10					
			50 HRc												
			55 HRc								2.30	0.09	0.18	1.40	0.06
			400 HB												
			Ni-Hard 2								2.30	0.09	0.18	1.40	0.06
			G-X300CrMo15												
NF Aluminium	12	AISI12	130 HB	0.30	6.60	0.10	0.30	0.99	3.00	0.23					

The depth of cut and feed rate tables are for the geometry and corner radius specified above the table. Refer to cutting speed tables on pages 186 and 187 for recommended materials per grade.

MACHINING CONDITIONS - TURNING - DEPTH OF CUT AND FEED

TNUX 160408 L
TNUX 160408 R

Material Group	Lamina Gr. N°	Material Examples	Hardness	DOC [mm]		Feed [mm/rev]		Amax [mm ²]	Suggested Starting Parameters																						
				min	max	min	max		DOC	Feed																					
P	Non Alloyed	C35, Ck45, 1020, 1045, 1060, 28Mn6	125 HB	0.50	5.00	0.21	0.50	1.80	3.00	0.38																					
			190 HB							0.35																					
			250 HB							0.33																					
	Low Alloyed	2	42CrMo4, S150, Ck60, 4140, 4340, 100Cr6	180 HB	0.50	5.00	0.21	0.45	1.20	3.00	0.32																				
				230 HB							4.00	0.18	0.40	1.00	2.70	0.30															
				280 HB		3.50	0.18	0.40	1.00	2.70	0.30																				
				350 HB								0.50	4.00	0.18	0.40	1.20	2.50	0.30													
	High Alloyed	3	X40CrMoV5, H13, M42, D3, S6-5-2, 12Ni19	220 HB	0.50	4.00	0.18	0.40	1.20	2.50	0.30																				
				280 HB								3.00	0.18	0.35	0.80	2.20	0.28														
				320 HB	0.50	4.00	0.18	0.40	1.20	2.50	0.30																				
	350 HB	0.50	5.00	0.20								0.40	1.20	3.00	0.25																
	Austenitic				4	304, 316, X5CrNi18-9	180 HB	0.50	5.00	0.20	0.40					1.20	3.00	0.25													
240 HB		0.50	4.00	0.18			0.35					0.80	2.50	0.24																	
Duplex	5				X2CrNiN23-4, S31500	290 HB		0.50	4.00	0.18	0.35				0.80	2.50	0.24														
		310 HB	0.50	5.00		0.18	0.40					0.70	2.50	0.20																	
Ferritic & Martensitic	6	410, X6Cr17, 17-4PH, 430			200 HB			0.50	4.00	0.18	0.40				0.70	2.20	0.20														
			42 HRc	0.50	5.00	0.15	0.60					2.00	3.00	0.35																	
Grey	7	GG20, GG40, EN-GJL-250, N030B	150 HB					0.50	5.00	0.15	0.60				2.00	3.00	0.35														
			200 HB	0.50	5.00	0.15	0.50					1.30	3.00	0.30																	
Malleable & Nodular	8	GGG40, GGG70, 50005	150 HB					0.50	5.00	0.15	0.50				1.50	3.00	0.30														
			200 HB	0.50	5.00	0.15	0.50					1.30	3.00	0.30																	
250 HB	0.50	5.00	0.15					0.50	1.30	3.00	0.30																				
Fe, Ni & Co based				9	Incoloy 800	240 HB	0.50					3.00	0.20	0.35	0.70	2.00	0.28														
	Inconel 700	250 HB	0.50		3.00	0.20		0.35	0.70	2.00	0.28																				
	Stellite 21	350 HB																0.50	3.00	0.20	0.35	0.70	2.00	0.28							
Ti based	10	T40		-			0.50					3.50	0.20	0.40	0.80	2.00	0.33														
		TiAl6V4	-	0.50	3.00	0.20		0.35	0.70	2.00	0.30																				
Steel	11	X100 CrMo13, 440C, G-X260NiCr42	45 HRc				0.50					2.50	0.11	0.30	0.60	2.00	0.25														
			50 HRc	0.50	2.00	0.11		0.25	0.40	1.50	0.20																				
			55 HRc															0.50	1.50	0.11	0.20	0.30	1.00	0.18							
			Ni-Hard 2																						0.50	2.00	0.11	0.25	0.40	1.50	0.18
			400 HB																												
55 HRc	0.50	1.50	0.11				0.20					0.30	1.00	0.15																	
G-X300CrMo15				0.50	1.50	0.11		0.20	0.30	1.00	0.15																				
White Cast Iron															0.50	1.50	0.11	0.20	0.30	1.00	0.15										
NF Aluminium																						12	AlSi12	130 HB	0.50	6.00	0.20	0.60	1.80	3.00	0.40

The depth of cut and feed rate tables are for the geometry and corner radius specified above the table. Refer to cutting speed tables on pages 186 and 187 for recommended materials per grade.

MACHINING CONDITIONS - TURNING - DEPTH OF CUT AND FEED

CNMA 120408
DNMA 150608

SNMA 120408
TNMA 160408

Material Group	Lamina Gr. N°	Material Examples	Hardness	DOC [mm]		Feed [mm/rev]		Amax [mm²]	Suggested Starting Parameters	
				min	max	min	max		DOC	Feed
K Grey Malleable & Nodular	7	GG20, GG40, EN-GJL-250, N030B	150 HB	0.5	6.0	0.15	0.40	1.35	3.5	0.30
			200 HB				0.38	1.20		
			250 HB				0.35	1.20		
	8	GGG40, GGG70, 50005	150 HB	0.5	6.0	0.15	0.40	1.00	2.5	0.30
			200 HB				0.38	0.90		
			250 HB				0.35	0.80		
H Chilled Cast Iron White Cast Iron	12	Ni-Hard 2	400 HB	0.5	2.2	0.11	0.20	0.30	1.4	0.15
	13	G-X300CrMo15	55 HRc	0.5	1.6	0.11	0.20	0.20	1.1	0.15

CNMA 120412
DNMA 150612

SNMA 120412
TNMA 160412

Material Group	Lamina Gr. N°	Material Examples	Hardness	DOC [mm]		Feed [mm/rev]		Amax [mm²]	Suggested Starting Parameters	
				min	max	min	max		DOC	Feed
K Grey Malleable & Nodular	7	GG20, GG40, EN-GJL-250, N030B	150 HB	0.8	6.0	0.15	0.60	1.50	3.5	0.43
			200 HB				0.48	1.40		0.40
			250 HB				0.45	1.35		0.38
	8	GGG40, GGG70, 50005	150 HB	0.8	6.0	0.15	0.48	1.30	3.0	0.43
			200 HB				0.40	1.10		0.36
			250 HB				0.38	1.00		0.33
H Chilled Cast Iron White Cast Iron	12	Ni-Hard 2	400 HB	0.8	2.4	0.11	0.25	0.30	1.5	0.20
	13	G-X300CrMo15	55 HRc	0.8	1.8	0.11	0.20	0.25	1.4	0.16

WNMA 080408

Material Group	Lamina Gr. N°	Material Examples	Hardness	DOC [mm]		Feed [mm/rev]		Amax [mm²]	Suggested Starting Parameters	
				min	max	min	max		DOC	Feed
K Grey Malleable & Nodular	7	GG20, GG40, EN-GJL-250, N030B	150 HB	0.5	2.0	0.15	0.40	1.4	1.75	0.30
			200 HB				0.38	1.2		
			250 HB				0.35	1.2		
	8	GGG40, GGG70, 50005	150 HB	0.5	2.0	0.15	0.40	1.0	1.50	0.30
			200 HB				0.38	0.9		
			250 HB				0.35	0.8		
H Chilled Cast Iron White Cast Iron	12	Ni-Hard 2	400 HB	0.5	2.0	0.11	0.20	0.3	1.4	0.15
	13	G-X300CrMo15	55 HRc	0.5	1.6	0.11	0.20	0.2	1.1	0.15

WNMA 080412

Material Group	Lamina Gr. N°	Material Examples	Hardness	DOC [mm]		Feed [mm/rev]		Amax [mm²]	Suggested Starting Parameters	
				min	max	min	max		DOC	Feed
K Grey Malleable & Nodular	7	GG20, GG40, EN-GJL-250, N030B	150 HB	0.8	2.0	0.20	0.60	1.9	1.75	0.40
			200 HB				0.58	1.7		
			250 HB				0.56	1.7		
	8	GGG40, GGG70, 50005	150 HB	0.8	2.0	0.20	0.52	1.4	1.50	0.30
			200 HB				0.50	1.2		
			250 HB				0.48	1.1		
H Chilled Cast Iron White Cast Iron	12	Ni-Hard 2	400 HB	0.8	2.0	0.14	0.25	0.4	1.6	0.19
	13	G-X300CrMo15	55 HRc	0.8	1.8	0.14	0.20	0.3	1.3	0.17

The depth of cut and feed rate tables are for the geometry and corner radius specified above the table. Refer to cutting speed tables on pages 186 and 187 for recommended materials per grade.

**We bring simplicity back to
the world of cutting tools**



MACHINING CONDITIONS

MILLING

MACHINING CONDITIONS - MILLING - CUTTING SPEEDS (Vc)

LT 30
 LT 3000
 LT 3130

Material Group	Lamina Gr. N°	Material Examples	Hardness	LT 30 / LT 3000 Vc [m/min]			LT 3130 Vc [m/min]		
				min	max	sugg. start speed	min	max	sugg. start speed
Non Alloyed Low Alloyed P High Alloyed	1	C35, Ck45, 1020, 1045, 1060, 28Mn6	125 HB	190	330	250	190	350	265
			190 HB		300	220		320	240
			250 HB		250	200		280	215
	2	42CrMo4, St50, Ck60, 4140, 4340, 100Cr6	180 HB	150	240	200	150	270	215
			230 HB		210	180		230	200
			280 HB	130	190	150	130	210	165
			350 HB		170	140		190	155
	3	X40CrMoV5, H13, M42, D3, S6-5-2, 12Ni19	220 HB	90	150	130	90	170	140
			280 HB		130	120		150	130
320 HB			60	110	100	60	120	110	
350 HB				90	80		100	90	
Austenitic M Duplex Ferritic & Martensitic	4	304, 316, X5CrNi18-9	180 HB	190	250	220	190	260	230
			240 HB		160	210		190	220
	5	X2CrNiN23-4, S31500	290 HB	70	130	100	70	140	110
			310 HB		120	90		130	100
	6	410, X6Cr17, 17-4PH, 430	200 HB	150	210	190	150	220	200
			42 HRc	90	150	130	90	160	140
Grey K Malleable & Nodular	7	GG20, GG40, EN-GJL-250, N030B	150 HB	150	240	200	-	-	-
			200 HB		220	180	-	-	-
			250 HB		190	160	-	-	-
	8	GGG40, GGG70, 50005	150 HB	100	200	180	-	-	-
			200 HB		180	150	-	-	-
			250 HB		150	130	-	-	-
Fe, Ni & Co based S Ti based	9	Incoloy 800	25	240 HB	45	32	-	-	-
		Inconel 700		250 HB	45	30	-	-	-
		Stellite 21		350 HB	45	30	-	-	-
	10	TiAl6V4	30	55	40	-	-	-	
		T40	40	65	55	-	-	-	
	Steel Chilled Cast Iron White Cast Iron	11	X100 CrMo13, 440C, G-X260NiCr42	45 HRc	40	80	60	-	-
50 HRc				70		55	-	-	-
55 HRc				60		50	-	-	-
400 HB				80		50	-	-	-
		G-X300CrMo15	55 HRc	30	60	40	-	-	-
NF Aluminium	12	AlSi12	130 HB	200	400	280	-	-	-

MACHINING CONDITIONS - MILLING - DEPTH OF CUT AND FEED

ADKT 1505 PDTR

Material Group	Lamina Gr. N°	Material Examples	Hardness	DOC [mm]		Feed [mm/z]		Suggested Starting Parameters	
				min	max	min	max	DOC	Feed
P Non Alloyed Low Alloyed High Alloyed	1	C35, Ck45, 1020, 1045, 1060, 28Mn6	125 HB	0.50	14.00	0.18	0.32	4.00	0.23
			190 HB						
			250 HB						
	2	42CrMo4, St50, Ck60, 4140, 4340, 100Cr6	180 HB	0.50	14.00	0.15	0.25	4.00	0.20
			230 HB				0.22		0.18
			280 HB						
			350 HB						
	3	X40CrMoV5, H13, M42, D3, S6-5-2, 12Ni19	220 HB	0.50	10.00	0.12	0.22	3.00	0.18
			280 HB				0.18		0.16
			320 HB						
			350 HB						
	M Austenitic Duplex Ferritic & Martensitic	4	304, 316, X5CrNi18-9	180 HB	0.50	14.00	0.15	4.00	0.20
240 HB				0.12					
5		X2CrNiN23-4, S31500	290 HB	0.50	10.00	0.12	0.18	3.00	0.16
			310 HB						
6		410, X6Cr17, 17-4PH, 430	200 HB	0.50	14.00	0.15	0.25	4.00	0.20
			42 HRc		10.00		0.20		
K Grey Malleable & Nodular	7	GG20, GG40, EN-GJL-250, N030B	150 HB	0.50	14.00	0.18	0.32	4.00	0.23
			200 HB						
			250 HB						
	8	GGG40, GGG70, 50005	150 HB	0.50	14.00	0.15	0.28	4.00	0.20
			200 HB						
			250 HB						
S Fe, Ni & Co based Ti based	9	Incoloy 800	240 HB	0.50	10.00	0.12	0.18	3.00	0.16
		Inconel 700	250 HB						
		Stellite 21	350 HB						
	10	TiAl6V4 T40	-	0.50	10.00	0.12	0.20	3.00	0.18
			-				0.18		0.16
			-				-		-
H Steel Chilled Cast Iron White Cast Iron	11	X100 CrMo13, 440C, G-X260NiCr42	45 HRc	0.50	5.00	0.10	0.18	2.00	0.14
			50 HRc		3.00		0.16	1.50	0.13
			55 HRc		1.50		0.14	1.00	0.12
			400 HB		4.00		0.18	1.50	0.14
			55 HRc		1.50		0.14	1.00	0.12
			G-X300CrMo15		-		-	-	-
NF Aluminium	12	AISI12	130 HB	0.50	14.00	0.18	0.32	4.00	0.25

The depth of cut and feed rate tables are for the geometry and corner radius specified above the table. Refer to cutting speed tables on page 226 for recommended materials per grade.

MACHINING CONDITIONS - MILLING - DEPTH OF CUT AND FEED

AOMT 123608 PETR

Material Group	Lamina Gr. N°	Material Examples	Hardness	DOC [mm]		Feed [mm/z]		Suggested Starting Parameters		
				min	max	min	max	DOC	Feed	
Non Alloyed	1	C35, Ck45, 1020, 1045, 1060, 28Mn6	125 HB	0.50	11.00	0.13	0.22	2.00	0.15	
			190 HB							
			250 HB							
P Low Alloyed	2	42CrMo4, St50, Ck60, 4140, 4340, 100Cr6	180 HB	0.50	11.00	0.11	0.18	2.00	0.13	
			230 HB				0.15		0.12	
			280 HB							
			350 HB							
High Alloyed	3	X40CrMoV5, H13, M42, D3, S6-5-2, 12Ni19	220 HB	0.50	7.90	0.08	0.15	1.50	0.12	
			280 HB				0.13		0.10	
			320 HB							
			350 HB							
M Austenitic	4	304, 316, X5CrNi18-9	180 HB	0.50	11.00	0.11	2.00	0.13		
			240 HB			0.18				
						0.08				
Duplex	5	X2CrNiN23-4, S31500	290 HB	0.50	7.90	0.08	0.13	1.50	0.10	
			310 HB							
Ferritic & Martensitic	6	410, X6Cr17, 17-4PH, 430	200 HB	0.50	11.00	0.11	0.18	2.00	0.13	
			42 HRc		7.90					0.08
K Grey	7	GG20, GG40, EN-GJL-250, N030B	150 HB	0.50	11.00	0.13	0.22	2.00	0.15	
			200 HB							
			250 HB							
Malleable & Nodular	8	GGG40, GGG70, 50005	150 HB	0.50	11.00	0.11	0.20	2.00	0.13	
			200 HB							
			250 HB							
S Fe, Ni & Co based	9	Incoloy 800	240 HB	0.50	7.90	0.08	0.13	1.50	0.10	
		Inconel 700	250 HB							
		Stellite 21	350 HB							
Ti based	10	TiAl6V4	-	0.50	7.90	0.08	0.14	1.50	0.12	
		T40	-				0.13		0.10	
H Steel	11	X100 CrMo13, 440C, G-X260NiCr42	45 HRc	0.50	3.90	0.07	0.13	1.00	0.09	
			50 HRc		2.40		0.11	0.80		
			55 HRc		1.20		0.10	0.50		
		Chilled Cast Iron	Ni-Hard 2		400 HB		3.10	0.13	0.80	0.09
			White Cast Iron		G-X300CrMo15		55 HRc	1.20	0.10	0.50
NF Aluminium	12	AlSi12	130 HB	0.50	11.00	0.13	0.22	2.00	0.16	

The depth of cut and feed rate tables are for the geometry and corner radius specified above the table. Refer to cutting speed tables on page 226 for recommended materials per grade.

MACHINING CONDITIONS - MILLING - DEPTH OF CUT AND FEED

APKT 060204 PDTR

Material Group	Lamina Gr. N°	Material Examples	Hardness	DOC [mm]		Feed [mm/z]		Suggested Starting Parameters		
				min	max	min	max	DOC	Feed	
P Non Alloyed Low Alloyed High Alloyed	1	C35, Ck45, 1020, 1045, 1060, 28Mn6	125 HB	0.30	5.50	0.04	0.13	1.30	0.07	
			190 HB							
			250 HB							
	2	42CrMo4, St50, Ck60, 4140, 4340, 100Cr6	180 HB	0.30	5.50	0.03	0.10	1.30	0.06	
			230 HB				0.09		0.05	
			280 HB							
			350 HB							
	3	X40CrMoV5, H13, M42, D3, S6-5-2, 12Ni19	220 HB	0.30	3.90	0.03	0.09	1.00	0.05	
			280 HB							
			320 HB							
			350 HB							
	M Austenitic Duplex Ferritic & Martensitic	4	304, 316, X5CrNi18-9	180 HB	0.30	5.50	0.03	0.10	1.30	0.06
240 HB				0.09						
5		X2CrNiN23-4, S31500	290 HB	0.30	3.90	0.03	0.07	1.00	0.05	
			310 HB							
6		410, X6Cr17, 17-4PH, 430	200 HB	0.30	5.50	0.03	0.10	1.30	0.06	
			42 HRc		3.90		0.08			1.00
K Grey Malleable & Nodular	7	GG20, GG40, EN-GJL-250, N030B	150 HB	0.30	5.50	0.04	0.13	1.30	0.07	
			200 HB							
			250 HB							
	8	GGG40, GGG70, 50005	150 HB	0.30	5.50	0.03	0.11	1.30	0.06	
			200 HB							
			250 HB							
S Fe, Ni & Co based Ti based	9	Incoloy 800	240 HB	0.30	3.90	0.03	0.07	1.00	0.05	
		Inconel 700	250 HB							
		Stellite 21	350 HB							
	10	TiAl6V4	-	0.30	3.90	0.03	0.08	1.00	0.05	
T40		-	0.07							
H Steel Chilled Cast Iron White Cast Iron	11	X100 CrMo13, 440C, G-X260NiCr42	45 HRc	0.30	2.00	0.02	0.07	0.70	0.04	
			50 HRc		1.20		0.06	0.50		
			55 HRc		0.60			0.30		
			Ni-Hard 2		400 HB			1.60		0.07
			G-X300CrMo15		55 HRc		0.60	0.06		0.30
NF Aluminium	12	AISI12	130 HB	0.30	5.50	0.04	0.13	1.30	0.08	

The depth of cut and feed rate tables are for the geometry and corner radius specified above the table. Refer to cutting speed tables on page 226 for recommended materials per grade.

MACHINING CONDITIONS - MILLING - DEPTH OF CUT AND FEED

APKT 0602-HF

Material Group	Lamina Gr. N°	Material Examples	Hardness	DOC [mm]		Feed [mm/z]		Suggested Starting Parameters	
				min	max	min	max	DOC	Feed
P	Non Alloyed	C35, Ck45, 1020, 1045, 1060, 28Mn6	125 HB	0.20	0.50	0.20	1.40	0.50	1.00
			190 HB						
			250 HB						
	Low Alloyed	42CrMo4, St50, Ck60, 4140, 4340, 100Cr6	180 HB	0.20	0.50	0.20	1.30	0.40	0.80
			230 HB						
			280 HB						
	High Alloyed	X40CrMoV5, H13, M42, D3, S6-5-2, 12Ni19	350 HB	0.20	0.40	0.20	1.10	0.40	0.70
			220 HB						
			280 HB						
M	Austenitic	304, 316, X5CrNi18-9	180 HB	0.20	0.40	0.20	0.70	0.40	0.50
			240 HB						
	Duplex	X2CrNiN23-4, S31500	290 HB	0.20	0.40	0.20	0.50	0.40	0.35
			310 HB						
	Ferritic & Martensitic	410, X6Cr17, 17-4PH, 430	200 HB	0.20	0.40	0.20	0.50	0.40	0.40
			42 HRc						
K	Grey	GG20, GG40, EN-GJL-250, N030B	150 HB	0.20	0.50	0.20	1.40	0.50	1.00
			200 HB						
			250 HB						
Malleable & Nodular	GGG40, GGG70, 50005	150 HB	0.20	0.50	0.20	1.20	0.50	0.90	
		200 HB							
		250 HB							
S	Fe, Ni & Co based	Incoloy 800	0.20	0.40	0.20	0.50	0.30	0.30	
		Inconel 700							
		Stellite 21							
	Ti based	TiAl6V4	0.20	0.40	0.20	0.40	0.30	0.30	
T40									
H	Steel	X100 CrMo13, 440C, G-X260NiCr42	0.20	0.30	0.20	0.70	0.40	0.40	
						0.60			
						0.50			
		Chilled Cast Iron	Ni-Hard 2	0.20	0.30	0.20	0.50	0.20	0.30
		White Cast Iron	G-X300CrMo15						
NF	Aluminium	AlSi12	0.20	0.50	0.20	0.70	0.50	0.60	

The depth of cut and feed rate tables are for the geometry and corner radius specified above the table. Refer to cutting speed tables on page 226 for recommended materials per grade.

MACHINING CONDITIONS - MILLING - DEPTH OF CUT AND FEED

APKT 100304 PDTR

Material Group	Lamina Gr. N°	Material Examples	Hardness	DOC [mm]		Feed [mm/z]		Suggested Starting Parameters	
				min	max	min	max	DOC	Feed
P Non Alloyed Low Alloyed High Alloyed	1	C35, Ck45, 1020, 1045, 1060, 28Mn6	125 HB	0.50	9.00	0.11	0.20	2.00	0.14
			190 HB						
			250 HB						
	2	42CrMo4, St50, Ck60, 4140, 4340, 100Cr6	180 HB	0.50	9.00	0.09	0.16	2.00	0.12
			230 HB				0.14		0.11
			280 HB						
			350 HB						
	3	X40CrMoV5, H13, M42, D3, S6-5-2, 12Ni19	220 HB	0.50	6.40	0.07	0.14	1.50	0.11
			280 HB				0.11		0.10
320 HB									
350 HB									
M Austenitic Duplex Ferritic & Martensitic	4	304, 316, X5CrNi18-9	180 HB	0.50	9.00	0.09	0.16	2.00	0.12
			240 HB				0.07		
	5	X2CrNiN23-4, S31500	290 HB	0.50	6.40	0.07	0.11	1.50	0.10
			310 HB						
	6	410, X6Cr17, 17-4PH, 430	200 HB	0.50	9.00	0.09	0.16	2.00	0.12
			42 HRc		6.40		0.12		
K Grey Malleable & Nodular	7	GG20, GG40, EN-GJL-250, N030B	150 HB	0.50	9.00	0.11	0.20	2.00	0.14
			200 HB						
			250 HB						
	8	GGG40, GGG70, 50005	150 HB	0.50	9.00	0.09	0.17	2.00	0.12
			200 HB						
			250 HB						
S Fe, Ni & Co based Ti based	9	Incoloy 800	0.50	6.40	0.07	0.11	1.50	0.10	
		Inconel 700							
		Stellite 21							
	10	TiAl6V4	0.50	6.40	0.07	0.12	1.50	0.11	
		T40				0.11		0.10	
H Steel Chilled Cast Iron White Cast Iron	11	X100 CrMo13, 440C, G-X260NiCr42	45 HRc	0.50	3.20	0.06	0.11	1.00	0.09
			50 HRc		1.90		0.10	0.80	0.08
			55 HRc		1.00		0.09	0.50	0.07
		Ni-Hard 2	400 HB		2.60		0.11	0.80	0.09
			G-X300CrMo15		55 HRc		1.00	0.09	0.50
		NF Aluminium			12		AISI12	130 HB	0.50

The depth of cut and feed rate tables are for the geometry and corner radius specified above the table. Refer to cutting speed tables on page 226 for recommended materials per grade.

MACHINING CONDITIONS - MILLING - DEPTH OF CUT AND FEED

APKT 100308 PDTR

Material Group	Lamina Gr. N°	Material Examples	Hardness	DOC [mm]		Feed [mm/z]		Suggested Starting Parameters	
				min	max	min	max	DOC	Feed
P Non Alloyed Low Alloyed High Alloyed	1	C35, Ck45, 1020, 1045, 1060, 28Mn6	125 HB	0.50	9.00	0.13	0.26	2.00	0.17
			190 HB						
			250 HB						
	2	42CrMo4, St50, Ck60, 4140, 4340, 100Cr6	180 HB	0.50	9.00	0.11	0.21	2.00	0.15
			230 HB				0.18		0.13
			280 HB						
			350 HB						
	3	X40CrMoV5, H13, M42, D3, S6-5-2, 12Ni19	220 HB	0.50	6.40	0.08	0.18	1.50	0.13
			280 HB				0.15		0.12
			320 HB						
			350 HB						
	M Austenitic Duplex Ferritic & Martensitic	4	304, 316, X5CrNi18-9	180 HB	0.50	9.00	0.11	2.00	0.15
240 HB				0.08					
5		X2CrNiN23-4, S31500	290 HB	0.50	6.40	0.08	0.15	1.50	0.12
			310 HB						
6		410, X6Cr17, 17-4PH, 430	200 HB	0.50	9.00	0.11	0.21	2.00	0.15
			42 HRc		6.40		0.16		
K Grey Malleable & Nodular	7	GG20, GG40, EN-GJL-250, N030B	150 HB	0.50	9.00	0.13	0.26	2.00	0.17
			200 HB						
			250 HB						
	8	GGG40, GGG70, 50005	150 HB	0.50	9.00	0.11	0.23	2.00	0.15
			200 HB						
			250 HB						
S Fe, Ni & Co based Ti based	9	Incoloy 800	0.50	6.40	0.08	0.15	1.50	0.12	
		Inconel 700							
		Stellite 21							
	10	TiAl6V4	0.50	6.40	0.08	0.16	1.50	0.13	
		T40				0.15		0.12	
	H Steel Chilled Cast Iron White Cast Iron	11	X100 CrMo13, 440C, G-X260NiCr42	45 HRc	0.50	3.20	0.07	0.15	1.00
50 HRc				1.90		0.13		0.80	0.09
55 HRc				1.00		0.11		0.50	0.09
Ni-Hard 2			400 HB	2.60		0.15		0.80	0.10
			G-X300CrMo15	55 HRc		1.00		0.11	0.50
NF Aluminium			12	AlSi12		130 HB		0.50	9.00

The depth of cut and feed rate tables are for the geometry and corner radius specified above the table. Refer to cutting speed tables on page 226 for recommended materials per grade.

MACHINING CONDITIONS - MILLING - DEPTH OF CUT AND FEED

APKT 100312 PDTR

Material Group	Lamina Gr. N°	Material Examples	Hardness	DOC [mm]		Feed [mm/z]		Suggested Starting Parameters		
				min	max	min	max	DOC	Feed	
P	Non Alloyed	C35, Ck45, 1020, 1045, 1060, 28Mn6	125 HB	0.50	9.00	0.13	0.28	2.00	0.20	
			190 HB							
			250 HB							
	Low Alloyed	2	42CrMo4, St50, Ck60, 4140, 4340, 100Cr6	180 HB	0.50	9.00	0.10	0.22	2.00	0.18
				230 HB				0.19		0.16
				280 HB						
				350 HB						
	High Alloyed	3	X40CrMoV5, H13, M42, D3, S6-5-2, 12Ni19	220 HB	0.50	6.40	0.08	0.19	1.50	0.16
				280 HB				0.16		0.14
				320 HB						
				350 HB						
	M	Austenitic	4	304, 316, X5CrNi18-9	0.50	9.00	0.10	0.22	2.00	0.18
240 HB				0.08						
Duplex		5	X2CrNiN23-4, S31500	290 HB	0.50	6.40	0.08	0.16	1.50	0.14
				310 HB						
Ferritic & Martensitic		6	410, X6Cr17, 17-4PH, 430	200 HB	0.50	9.00	0.10	0.22	2.00	0.18
				42 HRc		6.40		0.18		
K	Grey	7	GG20, GG40, EN-GJL-250, N030B	0.50	9.00	0.13	0.28	2.00	0.20	
			150 HB							
			200 HB							
	Malleable & Nodular	8	GGG40, GGG70, 50005	150 HB	0.50	9.00	0.10	0.25	2.00	0.18
				200 HB						
				250 HB						
S	Fe, Ni & Co based	9	Incoloy 800	0.50	6.40	0.08	0.16	1.50	0.14	
			240 HB							
			250 HB							
	Ti based	10	TiAl6V4	0.50	6.40	0.08	0.18	1.50	0.16	
			-				0.16		0.14	
			T40							
H	Steel	11	X100 CrMo13, 440C, G-X260NiCr42	0.50	3.20	0.07	0.16	1.00	0.12	
			45 HRc		1.90		0.14	0.80	0.11	
			50 HRc		1.00		0.12	0.50	0.10	
			55 HRc		2.60		0.16	0.80	0.12	
			400 HB		1.00		0.12	0.50	0.10	
			55 HRc							
Chilled Cast Iron	White Cast Iron	Ni-Hard 2	400 HB	0.50	6.40	0.08	0.16	0.80	0.12	
		G-X300CrMo15	55 HRc	0.50	6.40	0.08	0.12	0.50	0.10	
NF	Aluminium	12	AISI12	130 HB	0.50	9.00	0.13	0.28	2.00	0.22

The depth of cut and feed rate tables are for the geometry and corner radius specified above the table. Refer to cutting speed tables on page 226 for recommended materials per grade.

MACHINING CONDITIONS - MILLING - DEPTH OF CUT AND FEED

APKT 100316 PDTR

Material Group	Lamina Gr. N°	Material Examples	Hardness	DOC [mm]		Feed [mm/z]		Suggested Starting Parameters	
				min	max	min	max	DOC	Feed
P Non Alloyed Low Alloyed High Alloyed	1	C35, Ck45, 1020, 1045, 1060, 28Mn6	125 HB	0.50	9.00	0.13	0.28	2.00	0.20
			190 HB						
			250 HB						
	2	42CrMo4, St50, Ck60, 4140, 4340, 100Cr6	180 HB	0.50	9.00	0.10	0.22	2.00	0.18
			230 HB				0.19		0.16
			280 HB						
			350 HB						
	3	X40CrMoV5, H13, M42, D3, S6-5-2, 12Ni19	220 HB	0.50	6.40	0.08	0.19	1.50	0.16
			280 HB				0.16		0.14
			320 HB						
			350 HB						
	M Austenitic Duplex Ferritic & Martensitic	4	304, 316, X5CrNi18-9	180 HB	0.50	9.00	0.10	2.00	0.18
240 HB				0.08					
5		X2CrNiN23-4, S31500	290 HB	0.50	6.40	0.08	0.16	1.50	0.14
			310 HB						
6		410, X6Cr17, 17-4PH, 430	200 HB	0.50	9.00	0.10	0.22	2.00	0.18
			42 HRc		6.40		0.18		
K Grey Malleable & Nodular	7	GG20, GG40, EN-GJL-250, N030B	150 HB	0.50	9.00	0.13	0.28	2.00	0.20
			200 HB						
			250 HB						
	8	GGG40, GGG70, 50005	150 HB	0.50	9.00	0.10	0.25	2.00	0.18
			200 HB						
			250 HB						
S Fe, Ni & Co based Ti based	9	Incoloy 800	0.50	6.40	0.08	0.16	1.50	0.14	
		Inconel 700							
		Stellite 21							
	10	TiAl6V4	0.50	6.40	0.08	0.18	1.50	0.16	
		T40				0.16		0.14	
	H Steel Chilled Cast Iron White Cast Iron	11	X100 CrMo13, 440C, G-X260NiCr42	45 HRc	0.50	3.20	0.07	0.16	1.00
50 HRc				1.90		0.14		0.80	0.11
55 HRc				1.00		0.12		0.50	0.10
Ni-Hard 2			400 HB	2.60		0.16		0.80	0.12
			G-X300CrMo15	55 HRc		1.00		0.12	0.50
NF Aluminium				12		AlSi12		130 HB	0.50

The depth of cut and feed rate tables are for the geometry and corner radius specified above the table. Refer to cutting speed tables on page 226 for recommended materials per grade.

MACHINING CONDITIONS - MILLING - DEPTH OF CUT AND FEED

APKT 100332 PDTR

Material Group	Lamina Gr. N°	Material Examples	Hardness	DOC [mm]		Feed [mm/z]		Suggested Starting Parameters	
				min	max	min	max	DOC	Feed
P Non Alloyed Low Alloyed High Alloyed	1	C35, Ck45, 1020, 1045, 1060, 28Mn6	125 HB	0.50	9.00	0.13	0.32	1.00	0.23
			190 HB						
			250 HB						
	2	42CrMo4, St50, Ck60, 4140, 4340, 100Cr6	180 HB	0.50	9.00	0.10	0.25	1.00	0.20
			230 HB				0.22		0.18
			280 HB						
			350 HB						
	3	X40CrMoV5, H13, M42, D3, S6-5-2, 12Ni19	220 HB	0.50	6.40	0.08	0.22	1.00	0.18
			280 HB				0.18		0.16
			320 HB						
			350 HB						
	M Austenitic Duplex Ferritic & Martensitic	4	304, 316, X5CrNi18-9	180 HB	0.50	9.00	0.10	1.00	0.20
240 HB				0.08					
5		X2CrNiN23-4, S31500	290 HB	0.50	6.40	0.08	0.18	1.00	0.16
			310 HB						0.16
6		410, X6Cr17, 17-4PH, 430	200 HB	0.50	9.00	0.10	0.25	1.00	0.20
			42 HRc		6.40		0.20		0.16
K Grey Malleable & Nodular	7	GG20, GG40, EN-GJL-250, N030B	150 HB	0.50	9.00	0.13	0.32	1.00	0.23
			200 HB						
			250 HB						
	8	GGG40, GGG70, 50005	150 HB	0.50	9.00	0.10	0.28	1.00	0.20
			200 HB						
			250 HB						
S Fe, Ni & Co based Ti based	9	Incoloy 800	240 HB	0.50	6.40	0.08	0.18	1.00	0.16
		Inconel 700	250 HB						
		Stellite 21	350 HB						
	10	TiAl6V4 T40	-	0.50	6.40	0.08	0.20	1.00	0.18
			-				0.18		0.16
			-				-		-
H Steel Chilled Cast Iron White Cast Iron	11	X100 CrMo13, 440C, G-X260NiCr42	45 HRc	0.40	3.20	0.07	0.18	0.70	0.14
			50 HRc		1.90		0.16		0.13
			55 HRc		1.00		0.14		0.12
			400 HB		2.60		0.18		0.14
			55 HRc		1.00		0.14		0.12
			55 HRc		1.00		0.14		0.12
NF Aluminium	12	AISI12	130 HB	0.50	9.00	0.13	0.32	1.00	0.25

The depth of cut and feed rate tables are for the geometry and corner radius specified above the table. Refer to cutting speed tables on page 226 for recommended materials per grade.

MACHINING CONDITIONS - MILLING - DEPTH OF CUT AND FEED

APKT 100340 PDTR

Material Group	Lamina Gr. N°	Material Examples	Hardness	DOC [mm]		Feed [mm/z]		Suggested Starting Parameters	
				min	max	min	max	DOC	Feed
P Non Alloyed Low Alloyed High Alloyed	1	C35, Ck45, 1020, 1045, 1060, 28Mn6	125 HB	0.50	9.00	0.13	0.32	1.00	0.25
			190 HB						
			250 HB						
	2	42CrMo4, St50, Ck60, 4140, 4340, 100Cr6	180 HB	0.50	9.00	0.10	0.25	1.00	0.22
			230 HB						
			280 HB						
			350 HB						
	3	X40CrMoV5, H13, M42, D3, S6-5-2, 12Ni19	220 HB	0.50	6.40	0.08	0.22	1.00	0.20
			280 HB						
			320 HB						
			350 HB						
	M Austenitic Duplex Ferritic & Martensitic	4	304, 316, X5CrNi18-9	180 HB	0.50	9.00	0.10	1.00	0.22
240 HB				0.08					
5		X2CrNiN23-4, S31500	290 HB	0.50	6.40	0.08	0.18	1.00	0.18
			310 HB						
6		410, X6Cr17, 17-4PH, 430	200 HB	0.50	9.00	0.10	0.25	1.00	0.22
			42 HRc		6.40		0.20		0.18
K Grey Malleable & Nodular	7	GG20, GG40, EN-GJL-250, N030B	150 HB	0.50	9.00	0.13	0.32	1.00	0.25
			200 HB						
			250 HB						
	8	GGG40, GGG70, 50005	150 HB	0.50	9.00	0.10	0.28	1.00	0.22
			200 HB						
			250 HB						
S Fe, Ni & Co based Ti based	9	Incoloy 800	240 HB	0.50	6.40	0.08	0.18	1.00	0.18
		Inconel 700	250 HB						
		Stellite 21	350 HB						
	10	TiAl6V4	-	0.50	6.40	0.08	0.20	1.00	0.20
		T40	-				0.18		0.18
	H Steel Chilled Cast Iron White Cast Iron	11	X100 CrMo13, 440C, G-X260NiCr42	45 HRc	0.40	3.20	0.07	0.18	0.70
50 HRc				1.90		0.16		0.14	
55 HRc				1.00		0.14		0.13	
Ni-Hard 2			400 HB	2.60		0.18		0.15	
			G-X300CrMo15	55 HRc		1.00		0.14	
NF Aluminium			12	AlSi12		130 HB		0.50	

The depth of cut and feed rate tables are for the geometry and corner radius specified above the table. Refer to cutting speed tables on page 226 for recommended materials per grade.

MACHINING CONDITIONS - MILLING - DEPTH OF CUT AND FEED

APKT 1604 PDTR
APKT 160408 PDTR

Material Group	Lamina Gr. N°	Material Examples	Hardness	DOC [mm]		Feed [mm/z]		Suggested Starting Parameters	
				min	max	min	max	DOC	Feed
P Non Alloyed Low Alloyed High Alloyed	1	C35, Ck45, 1020, 1045, 1060, 28Mn6	125 HB	0.50	15.00	0.18	0.32	4.00	0.23
			190 HB						
			250 HB						
	2	42CrMo4, St50, Ck60, 4140, 4340, 100Cr6	180 HB	0.50	15.00	0.15	0.25	4.00	0.20
			230 HB				0.22		0.18
			280 HB						
			350 HB						
	3	X40CrMoV5, H13, M42, D3, S6-5-2, 12Ni19	220 HB	0.50	10.70	0.12	0.22	3.00	0.18
			280 HB				0.18		0.16
			320 HB						
			350 HB						
	M Austenitic Duplex Ferritic & Martensitic	4	304, 316, X5CrNi18-9	180 HB	0.50	15.00	0.15	4.00	0.20
240 HB				0.12					
5		X2CrNiN23-4, S31500	290 HB	0.50	10.70	0.12	0.18	3.00	0.16
			310 HB						
6		410, X6Cr17, 17-4PH, 430	200 HB	0.50	15.00	0.15	0.25	4.00	0.20
			42 HRc		10.70		0.20		
K Grey Malleable & Nodular	7	GG20, GG40, EN-GJL-250, N030B	150 HB	0.50	15.00	0.18	0.32	4.00	0.23
			200 HB						
			250 HB						
	8	GGG40, GGG70, 50005	150 HB	0.50	15.00	0.15	0.28	4.00	0.20
			200 HB						
			250 HB						
S Fe, Ni & Co based Ti based	9	Incoloy 800	240 HB	0.50	10.70	0.12	0.18	3.00	0.16
		Inconel 700	250 HB						
		Stellite 21	350 HB						
	10	TiAl6V4 T40	-	0.50	10.70	0.12	0.20	3.00	0.18
			-				0.18		0.16
			-				-		-
H Steel Chilled Cast Iron White Cast Iron	11	X100 CrMo13, 440C, G-X260NiCr42	45 HRc	0.50	5.40	0.10	0.18	2.00	0.14
			50 HRc		3.20		0.16	1.50	0.13
			55 HRc		1.60		0.14	1.00	0.12
			400 HB		4.30		0.18	1.50	0.14
			55 HRc		1.60		0.14	1.00	0.12
			-		-		-	-	-
NF Aluminium	12	AISI12	130 HB	0.50	15.00	0.18	0.32	4.00	0.25

The depth of cut and feed rate tables are for the geometry and corner radius specified above the table. Refer to cutting speed tables on page 226 for recommended materials per grade.

MACHINING CONDITIONS - MILLING - DEPTH OF CUT AND FEED

APKT 160416 PDTR

Material Group	Lamina Gr. N°	Material Examples	Hardness	DOC [mm]		Feed [mm/z]		Suggested Starting Parameters	
				min	max	min	max	DOC	Feed
P Non Alloyed Low Alloyed High Alloyed	1	C35, Ck45, 1020, 1045, 1060, 28Mn6	125 HB	0.50	15.00	0.18	0.32	5.00	0.23
			190 HB						
			250 HB						
	2	42CrMo4, St50, Ck60, 4140, 4340, 100Cr6	180 HB	0.50	15.00	0.15	0.25	5.00	0.20
			230 HB				0.22		0.18
			280 HB						
			350 HB						
	3	X40CrMoV5, H13, M42, D3, S6-5-2, 12Ni19	220 HB	0.50	10.70	0.12	0.22	3.80	0.18
			280 HB				0.18		0.16
320 HB									
350 HB									
M Austenitic Duplex Ferritic & Martensitic	4	304, 316, X5CrNi18-9	180 HB	0.50	15.00	0.15	5.00	0.20	
			240 HB			0.12			
	5	X2CrNiN23-4, S31500	290 HB	0.50	10.70	0.12	0.18	3.80	0.16
			310 HB						
	6	410, X6Cr17, 17-4PH, 430	200 HB	0.50	15.00	0.15	0.25	5.00	0.20
			42 HRc		10.70		0.20		
K Grey Malleable & Nodular	7	GG20, GG40, EN-GJL-250, N030B	150 HB	0.50	15.00	0.18	0.32	5.00	0.23
			200 HB						
			250 HB						
	8	GGG40, GGG70, 50005	150 HB	0.50	15.00	0.15	0.28	5.00	0.20
			200 HB						
			250 HB						
S Fe, Ni & Co based Ti based	9	Incoloy 800	0.50	10.70	0.12	0.18	3.80	0.16	
		Inconel 700							
		Stellite 21							
	10	TiAl6V4	0.50	10.70	0.12	0.20	3.80	0.18	
		T40				0.18		0.16	
	H Steel Chilled Cast Iron White Cast Iron	11	X100 CrMo13, 440C, G-X260NiCr42	45 HRc	0.50	5.40	0.10	0.18	2.50
50 HRc				3.20		0.16		1.90	0.13
55 HRc				1.60		0.14		1.30	0.12
Ni-Hard 2			400 HB	4.30		0.18		1.90	0.14
			G-X300CrMo15	55 HRc		1.60		0.14	1.30
NF Aluminium				12		AlSi12		130 HB	0.50

The depth of cut and feed rate tables are for the geometry and corner radius specified above the table. Refer to cutting speed tables on page 226 for recommended materials per grade.

MACHINING CONDITIONS - MILLING - DEPTH OF CUT AND FEED

APKT 160424 PDTR

Material Group	Lamina Gr. N°	Material Examples	Hardness	DOC [mm]		Feed [mm/z]		Suggested Starting Parameters	
				min	max	min	max	DOC	Feed
P High Alloyed	1	C35, Ck45, 1020, 1045, 1060, 28Mn6	125 HB	0.50	15.00	0.18	0.32	5.00	0.23
			190 HB						
			250 HB						
	2	42CrMo4, St50, Ck60, 4140, 4340, 100Cr6	180 HB	0.50	15.00	0.15	0.25	5.00	0.20
			230 HB				0.22		0.18
			280 HB						
			350 HB						
	3	X40CrMoV5, H13, M42, D3, S6-5-2, 12Ni19	220 HB	0.50	10.70	0.12	0.22	3.80	0.18
			280 HB				0.18		0.16
			320 HB						
			350 HB						
	M Ferritic & Martensitic	4	304, 316, X5CrNi18-9	180 HB	0.50	15.00	0.15	5.00	0.20
240 HB				0.12					
5		X2CrNiN23-4, S31500	290 HB	0.50	10.70	0.12	0.18	3.80	0.16
			310 HB						
6		410, X6Cr17, 17-4PH, 430	200 HB	0.50	15.00	0.15	0.25	5.00	0.20
			42 HRc		10.70		0.20		
K Malleable & Nodular	7	GG20, GG40, EN-GJL-250, N030B	150 HB	0.50	15.00	0.18	0.32	5.00	0.23
			200 HB						
			250 HB						
	8	GGG40, GGG70, 50005	150 HB	0.50	15.00	0.15	0.28	5.00	0.20
			200 HB						
			250 HB						
S Ti based	9	Incoloy 800	0.50	10.70	0.12	0.18	3.80	0.16	
		Inconel 700							
		Stellite 21							
	10	TiAl6V4	0.50	10.70	0.12	0.20	3.80	0.18	
		T40				0.18		0.16	
H White Cast Iron	11	X100 CrMo13, 440C, G-X260NiCr42	45 HRc	0.50	5.40	0.10	0.18	2.50	0.14
			50 HRc		3.20		0.16	1.90	0.13
			55 HRc		1.60		0.14	1.30	0.12
		Ni-Hard 2	0.50	4.30	0.18		1.90	0.14	
		G-X300CrMo15	0.50	1.60	0.14		1.30	0.12	
NF Aluminium	12	AISI12	130 HB	0.50	15.00	0.18	0.32	5.00	0.25

The depth of cut and feed rate tables are for the geometry and corner radius specified above the table. Refer to cutting speed tables on page 226 for recommended materials per grade.

MACHINING CONDITIONS - MILLING - DEPTH OF CUT AND FEED

APKT 160432 PDTR

Material Group	Lamina Gr. N°	Material Examples	Hardness	DOC [mm]		Feed [mm/z]		Suggested Starting Parameters	
				min	max	min	max	DOC	Feed
P Non Alloyed Low Alloyed High Alloyed	1	C35, Ck45, 1020, 1045, 1060, 28Mn6	125 HB	0.50	15.00	0.18	0.32	5.00	0.23
			190 HB						
			250 HB						
	2	42CrMo4, St50, Ck60, 4140, 4340, 100Cr6	180 HB	0.50	15.00	0.15	0.25	5.00	0.20
			230 HB				0.22		0.18
			280 HB						
			350 HB						
	3	X40CrMoV5, H13, M42, D3, S6-5-2, 12Ni19	220 HB	0.50	10.70	0.12	0.22	3.80	0.18
			280 HB				0.18		0.16
320 HB									
350 HB									
M Austenitic Duplex Ferritic & Martensitic	4	304, 316, X5CrNi18-9	180 HB	0.50	15.00	0.15	5.00	0.20	
			240 HB			0.12			
	5	X2CrNiN23-4, S31500	290 HB	0.50	10.70	0.12	0.18	3.80	0.16
			310 HB						
	6	410, X6Cr17, 17-4PH, 430	200 HB	0.50	15.00	0.15	0.25	5.00	0.20
			42 HRc		10.70		0.20		
K Grey Malleable & Nodular	7	GG20, GG40, EN-GJL-250, N030B	150 HB	0.50	15.00	0.18	0.32	5.00	0.23
			200 HB						
			250 HB						
	8	GGG40, GGG70, 50005	150 HB	0.50	15.00	0.15	0.28	5.00	0.20
			200 HB						
			250 HB						
S Fe, Ni & Co based Ti based	9	Incoloy 800	0.50	10.70	0.12	0.18	3.80	0.16	
		Inconel 700							
		Stellite 21							
	10	TiAl6V4	0.50	10.70	0.12	0.20	3.80	0.18	
		T40				0.18		0.16	
	H Steel Chilled Cast Iron White Cast Iron	11	X100 CrMo13, 440C, G-X260NiCr42	45 HRc	0.50	5.40	0.10	0.18	2.50
50 HRc				3.20		0.16		1.90	0.13
55 HRc				1.60		0.14		1.30	0.12
Ni-Hard 2			400 HB	4.30		0.18		1.90	0.14
			G-X300CrMo15	55 HRc		1.60		0.14	1.30
NF Aluminium				12		AlSi12		130 HB	0.50

The depth of cut and feed rate tables are for the geometry and corner radius specified above the table. Refer to cutting speed tables on page 226 for recommended materials per grade.

MACHINING CONDITIONS - MILLING - DEPTH OF CUT AND FEED

APKT 1705 PETR

Material Group	Lamina Gr. N°	Material Examples	Hardness	DOC [mm]		Feed [mm/z]		Suggested Starting Parameters		
				min	max	min	max	DOC	Feed	
P Non Alloyed Low Alloyed High Alloyed	1	C35, Ck45, 1020, 1045, 1060, 28Mn6	125 HB	0.50	15.00	0.18	0.40	4.00	0.28	
			190 HB							
			250 HB							
	2	42CrMo4, St50, Ck60, 4140, 4340, 100Cr6	180 HB	0.50	15.00	0.15	0.31	4.00	0.24	
			230 HB				0.27		0.22	
			280 HB							
			350 HB							
	3	X40CrMoV5, H13, M42, D3, S6-5-2, 12Ni19	220 HB	0.50	10.70	0.12	0.27	3.00	0.22	
			280 HB				0.22		0.19	
			320 HB							
			350 HB							
	M Austenitic Duplex Ferritic & Martensitic	4	304, 316, X5CrNi18-9	180 HB	0.50	15.00	0.15	4.00	0.24	
240 HB				0.12						
5		X2CrNiN23-4, S31500	290 HB	0.50	10.70	0.12	0.22	3.00	0.19	
			310 HB							
6		410, X6Cr17, 17-4PH, 430	200 HB	0.50	15.00	0.15	0.31	4.00	0.24	
			42 HRc		10.70		0.25			3.00
K Grey Malleable & Nodular	7	GG20, GG40, EN-GJL-250, N030B	150 HB	0.50	15.00	0.18	0.40	4.00	0.28	
			200 HB							
			250 HB							
	8	GGG40, GGG70, 50005	150 HB	0.50	15.00	0.15	0.35	4.00	0.24	
			200 HB							
			250 HB							
S Fe, Ni & Co based Ti based	9	Incoloy 800	240 HB	0.50	10.70	0.12	0.22	3.00	0.19	
		Inconel 700	250 HB							
		Stellite 21	350 HB							
	10	TiAl6V4	-	0.50	10.70	0.12	0.25	3.00	0.22	
		T40	-				0.22		0.19	
H Steel Chilled Cast Iron White Cast Iron	11	X100 CrMo13, 440C, G-X260NiCr42	45 HRc	0.50	5.40	0.10	0.22	2.00	0.17	
			50 HRc		3.20		0.20	1.50	0.16	
			55 HRc		1.60		0.17	1.00	0.14	
		Ni-Hard 2	400 HB		4.30		0.22	1.50	0.17	
			G-X300CrMo15		55 HRc		1.60	0.17	1.00	0.14
NF Aluminium	12	AISI12	130 HB	0.50	15.00	0.18	0.40	4.00	0.30	

The depth of cut and feed rate tables are for the geometry and corner radius specified above the table. Refer to cutting speed tables on page 226 for recommended materials per grade.

MACHINING CONDITIONS - MILLING - DEPTH OF CUT AND FEED

APKW 0602-HF

Material Group	Lamina Gr. N°	Material Examples	Hardness	DOC [mm]		Feed [mm/z]		Suggested Starting Parameters	
				min	max	min	max	DOC	Feed
Non Alloyed P Low Alloyed High Alloyed	1	C35, Ck45, 1020, 1045, 1060, 28Mn6	125 HB	0.20	0.50	0.20	1.40	0.50	1.00
			190 HB						
			250 HB						
	2	42CrMo4, St50, Ck60, 4140, 4340, 100Cr6	180 HB	0.20	0.50	0.20	1.30	0.40	0.80
			230 HB						
			280 HB					0.40	0.70
			350 HB						
	3	X40CrMoV5, H13, M42, D3, S6-5-2, 12Ni19	220 HB	0.20	0.40	0.20	1.10	0.40	0.70
			280 HB						
			320 HB					0.40	0.60
			350 HB						
	Ferritic & Martensitic	6	410, X6Cr17, 17-4PH, 430	200 HB	0.20	0.40	0.20	0.50	0.40
42 HRc				0.60					
Grey K Malleable & Nodular	7	GG20, GG40, EN-GJL-250, N030B	150 HB	0.20	0.50	0.20	1.40	0.50	1.00
			200 HB						
			250 HB						
	8	GGG40, GGG70, 50005	150 HB	0.20	0.50	0.20	1.20	0.50	0.90
			200 HB					0.40	
			250 HB						
Steel H Chilled Cast Iron White Cast Iron	11	X100 CrMo13, 440C, G-X260NiCr42	45 HRc	0.20	0.40	0.20	0.80	0.40	0.50
			50 HRc		0.30		0.70		0.40
			55 HRc				0.30		0.30
		Ni-Hard 2	0.20	0.30	0.20	0.50	0.30	0.40	
		G-X300CrMo15	0.20	0.30	0.20	0.50	0.30	0.30	

The depth of cut and feed rate tables are for the geometry and corner radius specified above the table. Refer to cutting speed tables on page 226 for recommended materials per grade.

MACHINING CONDITIONS - MILLING - DEPTH OF CUT AND FEED

APMT 1135 PDTR

Material Group	Lamina Gr. N°	Material Examples	Hardness	DOC [mm]		Feed [mm/z]		Suggested Starting Parameters	
				min	max	min	max	DOC	Feed
P Non Alloyed Low Alloyed High Alloyed	1	C35, Ck45, 1020, 1045, 1060, 28Mn6	125 HB	0.50	10.00	0.13	0.22	2.00	0.15
			190 HB						
			250 HB						
	2	42CrMo4, St50, Ck60, 4140, 4340, 100Cr6	180 HB	0.50	10.00	0.10	0.17	2.00	0.13
			230 HB						
			280 HB				0.15		0.12
			350 HB						
	3	X40CrMoV5, H13, M42, D3, S6-5-2, 12Ni19	220 HB	0.50	7.20	0.08	0.15	1.50	0.12
			280 HB						
			320 HB				0.13		0.10
			350 HB						
	M Austenitic Duplex Ferritic & Martensitic	4	304, 316, X5CrNi18-9	180 HB	0.50	10.00	0.10	0.17	2.00
240 HB									
5		X2CrNiN23-4, S31500	290 HB	0.50	7.20	0.08	0.13	1.50	0.10
			310 HB						
6		410, X6Cr17, 17-4PH, 430	200 HB	0.50	10.00	0.10	0.17	2.00	0.13
			42 HRc		7.20				
K Grey Malleable & Nodular	7	GG20, GG40, EN-GJL-250, N030B	150 HB	0.50	10.00	0.13	0.22	2.00	0.15
			200 HB						
			250 HB						
	8	GGG40, GGG70, 50005	150 HB	0.50	10.00	0.10	0.20	2.00	0.13
			200 HB						
			250 HB						
S Fe, Ni & Co based Ti based	9	Incoloy 800	0.50	7.20	0.08	0.13	1.50	0.10	
		Inconel 700							
		Stellite 21							
	10	TiAl6V4	0.50	7.20	0.08	0.14	1.50	0.12	
		T40							
		-							
H Steel Chilled Cast Iron White Cast Iron	11	X100 CrMo13, 440C, G-X260NiCr42	45 HRc	0.50	3.60	0.07	0.13	1.00	0.09
			50 HRc		2.10		0.11	0.80	0.08
			55 HRc		1.10		0.10	0.50	0.08
			400 HB		2.90		0.13	0.80	0.09
			55 HRc		1.10		0.10	0.50	0.08
			G-X300CrMo15						
NF Aluminium	12	AISI12	130 HB	0.50	10.00	0.13	0.22	2.00	0.16

The depth of cut and feed rate tables are for the geometry and corner radius specified above the table. Refer to cutting speed tables on page 226 for recommended materials per grade.

MACHINING CONDITIONS - MILLING - DEPTH OF CUT AND FEED

APMT 1604 PDTR
APMT 160408 PDTR

Material Group	Lamina Gr. N°	Material Examples	Hardness	DOC [mm]		Feed [mm/z]		Suggested Starting Parameters		
				min	max	min	max	DOC	Feed	
P	Non Alloyed	C35, Ck45, 1020, 1045, 1060, 28Mn6	125 HB	0.50	15.00	0.16	0.30	4.00	0.21	
			190 HB							
			250 HB							
	Low Alloyed	2	42CrMo4, St50, Ck60, 4140, 4340, 100Cr6	180 HB	0.50	15.00	0.14	0.23	4.00	0.18
				230 HB						
				280 HB						
				350 HB						
	High Alloyed	3	X40CrMoV5, H13, M42, D3, S6-5-2, 12Ni19	220 HB	0.50	10.70	0.11	0.20	3.00	0.16
				280 HB						
320 HB										
350 HB										
M	Austenitic	4	304, 316, X5CrNi18-9	180 HB	0.50	15.00	0.14	4.00	0.18	
				240 HB			0.11			
	Duplex	5	X2CrNiN23-4, S31500	290 HB	0.50	10.70	0.11	0.17	3.00	0.14
				310 HB						
	Ferritic & Martensitic	6	410, X6Cr17, 17-4PH, 430	200 HB	0.50	15.00	0.14	0.23	4.00	0.18
				42 HRc		10.70		0.19		
K	Grey	7	GG20, GG40, EN-GJL-250, N030B	150 HB	0.50	15.00	0.16	0.30	4.00	0.21
				200 HB						
				250 HB						
Malleable & Nodular	8	GGG40, GGG70, 50005	150 HB	0.50	15.00	0.14	0.26	4.00	0.18	
			200 HB							
			250 HB							
S	Fe, Ni & Co based	9	Incoloy 800	0.50	10.70	0.11	0.17	3.00	0.14	
			Inconel 700							
			Stellite 21							
	Ti based	10	TiAl6V4	0.50	10.70	0.11	0.19	3.00	0.16	
T40	-	0.17	0.14							
H	Steel	11	X100 CrMo13, 440C, G-X260NiCr42	0.50	5.40	0.09	0.17	2.00	0.13	
					3.20		0.15	1.50	0.12	
					1.60		0.13	1.00	0.11	
					4.30		0.17	1.50	0.13	
					1.60		0.13	1.00	0.11	
White Cast Iron	Ni-Hard 2	400 HB	55 HRc	0.50	1.60	0.09	0.13	1.00	0.11	
										G-X300CrMo15
NF	Aluminium	12	AlSi12	130 HB	0.50	15.00	0.16	0.30	4.00	0.22

The depth of cut and feed rate tables are for the geometry and corner radius specified above the table. Refer to cutting speed tables on page 226 for recommended materials per grade.

MACHINING CONDITIONS - MILLING - DEPTH OF CUT AND FEED

HNKX 0604-45

Material Group	Lamina Gr. N°	Material Examples	Hardness	DOC [mm]		Feed [mm/z]		Suggested Starting Parameters	
				min	max	min	max	DOC	Feed
P Non Alloyed Low Alloyed High Alloyed	1	C35, Ck45, 1020, 1045, 1060, 28Mn6	125 HB	0.50	3.50	0.16	0.34	2.50	0.30
			190 HB						
			250 HB						
	2	42CrMo4, St50, Ck60, 4140, 4340, 100Cr6	180 HB	0.50	3.50	0.14	0.28	2.50	0.26
			230 HB				0.26		0.24
			280 HB						
			350 HB						
	3	X40CrMoV5, H13, M42, D3, S6-5-2, 12Ni19	220 HB	0.50	3.50	0.11	0.28	2.50	0.26
			280 HB				0.24		0.22
			320 HB						
			350 HB						
	M Austenitic Duplex Ferritic & Martensitic	4	304, 316, X5CrNi18-9	180 HB	0.50	3.50	0.14	0.30	2.50
240 HB				0.11					
5		X2CrNiN23-4, S31500	290 HB	0.50	3.00	0.11	0.25	1.70	0.22
			310 HB						
6		410, X6Cr17, 17-4PH, 430	200 HB	0.50	3.50	0.14	0.30	2.00	0.26
			42 HRc		3.00		0.25		0.22
K Grey Malleable & Nodular	7	GG20, GG40, EN-GJL-250, N030B	150 HB	0.50	3.50	0.17	0.34	2.00	0.30
			200 HB						
			250 HB						
	8	GGG40, GGG70, 50005	150 HB	0.50	3.50	0.14	0.30	2.00	0.27
			200 HB						
			250 HB						
S Fe, Ni & Co based Ti based	9	Incoloy 800	240 HB	0.50	3.00	0.11	0.20	1.70	0.18
		Inconel 700	250 HB						
		Stellite 21	350 HB						
	10	TiAl6V4 T40	-	0.50	3.00	0.11	0.25	1.70	0.23
			-				0.23		0.20
			-				-		-
H Steel Chilled Cast Iron White Cast Iron	11	X100 CrMo13, 440C, G-X260NiCr42	45 HRc	0.40	1.50	0.10	0.22	1.00	0.18
			50 HRc		1.50		0.20	1.00	0.16
			55 HRc		1.00		0.18	0.70	0.15
			400 HB		1.50		0.22	1.00	0.19
			55 HRc		1.00		0.20	0.70	0.17
			G-X300CrMo15		55 HRc		1.00	0.20	0.70
NF Aluminium	12	AISI12	130 HB	0.50	3.50	0.17	0.36	2.00	0.30

The depth of cut and feed rate tables are for the geometry and corner radius specified above the table. Refer to cutting speed tables on page 226 for recommended materials per grade.

MACHINING CONDITIONS - MILLING - DEPTH OF CUT AND FEED

LDMT 1504 PDSR

Material Group	Lamina Gr. N°	Material Examples	Hardness	DOC [mm]		Feed [mm/z]		Suggested Starting Parameters	
				min	max	min	max	DOC	Feed
P Non Alloyed Low Alloyed High Alloyed	1	C35, Ck45, 1020, 1045, 1060, 28Mn6	125 HB	0.50	14.00	0.18	0.32	4.00	0.23
			190 HB						
			250 HB						
	2	42CrMo4, St50, Ck60, 4140, 4340, 100Cr6	180 HB	0.50	14.00	0.15	0.25	4.00	0.20
			230 HB				0.22		0.18
			280 HB						
			350 HB						
	3	X40CrMoV5, H13, M42, D3, S6-5-2, 12Ni19	220 HB	0.50	10.00	0.12	0.22	3.00	0.18
			280 HB				0.18		0.16
			320 HB						
			350 HB						
	M Austenitic Duplex Ferritic & Martensitic	4	304, 316, X5CrNi18-9	180 HB	0.50	14.00	0.15	4.00	0.20
240 HB				0.12					
5		X2CrNiN23-4, S31500	290 HB	0.50	10.00	0.12	0.18	3.00	0.16
			310 HB						
6		410, X6Cr17, 17-4PH, 430	200 HB	0.50	14.00	0.15	0.25	4.00	0.20
			42 HRc		10.00		0.20		
K Grey Malleable & Nodular	7	GG20, GG40, EN-GJL-250, N030B	150 HB	0.50	14.00	0.18	0.32	4.00	0.23
			200 HB						
			250 HB						
	8	GGG40, GGG70, 50005	150 HB	0.50	14.00	0.15	0.28	4.00	0.20
			200 HB						
			250 HB						
S Fe, Ni & Co based Ti based	9	Incoloy 800	0.50	10.00	0.12	0.18	3.00	0.16	
		Inconel 700							
		Stellite 21							
	10	TiAl6V4	0.50	10.00	0.12	0.20	3.00	0.18	
		T40				0.18		0.16	
	H Steel Chilled Cast Iron White Cast Iron	11	X100 CrMo13, 440C, G-X260NiCr42	45 HRc	0.50	5.00	0.10	0.18	2.00
50 HRc				3.00		0.16		1.50	0.13
55 HRc				1.50		0.14		1.00	0.12
Ni-Hard 2			400 HB	4.00		0.18		1.50	0.14
			G-X300CrMo15	55 HRc		1.50		0.14	1.00
NF Aluminium				12		AlSi12		130 HB	0.50

The depth of cut and feed rate tables are for the geometry and corner radius specified above the table. Refer to cutting speed tables on page 226 for recommended materials per grade.

MACHINING CONDITIONS - MILLING - DEPTH OF CUT AND FEED

ODMT 0504 ZZTR
 OFMT 050405 TR
 OFMT 05T305 TN

Material Group	Lamina Gr. N°	Material Examples	Hardness	DOC [mm]		Feed [mm/z]		Suggested Starting Parameters		
				min	max	min	max	DOC	Feed	
P Non Alloyed Low Alloyed High Alloyed	1	C35, Ck45, 1020, 1045, 1060, 28Mn6	125 HB	0.50	3.50	0.22	0.51	2.40	0.37	
			190 HB							
			250 HB							
	2	42CrMo4, St50, Ck60, 4140, 4340, 100Cr6	180 HB	0.50	3.50	0.18	0.40	2.40	0.32	
			230 HB				0.35		0.29	
			280 HB							
			350 HB							
	3	X40CrMoV5, H13, M42, D3, S6-5-2, 12Ni19	220 HB	0.50	2.50	0.14	0.35	1.80	0.29	
			280 HB				0.29		0.26	
			320 HB							
			350 HB							
	M Austenitic Duplex Ferritic & Martensitic	4	304, 316, X5CrNi18-9	180 HB	0.50	3.50	0.18	2.40	0.29	
240 HB				0.14						
5		X2CrNiN23-4, S31500	290 HB	0.50	2.50	0.14	0.29	1.80	0.26	
			310 HB							
6		410, X6Cr17, 17-4PH, 430	200 HB	0.50	3.50	0.18	0.35	2.40	0.29	
			42 HRc		2.50		0.32			1.80
K Grey Malleable & Nodular	7	GG20, GG40, EN-GJL-250, N030B	150 HB	0.50	3.50	0.22	0.51	2.40	0.37	
			200 HB							
			250 HB							
	8	GGG40, GGG70, 50005	150 HB	0.50	3.50	0.18	0.45	2.40	0.32	
			200 HB							
			250 HB							
S Fe, Ni & Co based Ti based	9	Incoloy 800	240 HB	0.50	2.50	0.14	0.29	1.80	0.26	
		Inconel 700	250 HB							
		Stellite 21	350 HB							
	10	TiAl6V4	-	0.50	2.50	0.14	0.32	1.80	0.29	
		T40	-				0.29		0.26	
H Steel Chilled Cast Iron White Cast Iron	11	X100 CrMo13, 440C, G-X260NiCr42	45 HRc	0.40	1.30	0.12	0.29	1.20	0.22	
			50 HRc		1.00		0.26	0.90	0.21	
			55 HRc		0.80		0.22	0.60	0.19	
		Ni-Hard 2	400 HB		1.00		0.29	0.90	0.22	
			G-X300CrMo15		55 HRc		0.80	0.22	0.60	0.19
NF Aluminium	12	AISI12	130 HB	0.50	3.50	0.22	0.51	2.40	0.40	

The depth of cut and feed rate tables are for the geometry and corner radius specified above the table. Refer to cutting speed tables on page 226 for recommended materials per grade.

MACHINING CONDITIONS - MILLING - DEPTH OF CUT AND FEED

ODMT 060508 TN

Material Group	Lamina Gr. N°	Material Examples	Hardness	DOC [mm]		Feed [mm/z]		Suggested Starting Parameters		
				min	max	min	max	DOC	Feed	
Non Alloyed	1	C35, Ck45, 1020, 1045, 1060, 28Mn6	125 HB	0.50	4.00	0.22	0.54	2.50	0.39	
			190 HB							
			250 HB							
Low Alloyed	2	42CrMo4, St50, Ck60, 4140, 4340, 100Cr6	180 HB	0.50	4.00	0.18	0.43	2.50	0.34	
			230 HB				0.37		0.31	
			280 HB							
			350 HB							
High Alloyed	3	X40CrMoV5, H13, M42, D3, S6-5-2, 12Ni19	220 HB	0.50	2.80	0.14	0.37	1.90	0.31	
			280 HB				0.31		0.27	
			320 HB							
			350 HB							
Austenitic	4	304, 316, X5CrNi18-9	180 HB	0.50	4.00	0.18	2.50	0.31		
			240 HB			0.37				
						0.14			0.34	
M Duplex	5	X2CrNiN23-4, S31500	290 HB	0.50	2.80	0.14	0.31	1.90	0.27	
			310 HB							
Ferritic & Martensitic	6	410, X6Cr17, 17-4PH, 430	200 HB	0.50	4.00	0.18	0.37	2.50	0.31	
			42 HRc		2.80		0.34	1.90	0.27	
Grey	7	GG20, GG40, EN-GJL-250, N030B	150 HB	0.50	4.00	0.22	0.54	2.50	0.39	
			200 HB							
			250 HB							
Malleable & Nodular	8	GGG40, GGG70, 50005	150 HB	0.50	4.00	0.18	0.48	2.50	0.34	
			200 HB							
			250 HB							
Fe, Ni & Co based	9	Incoloy 800	240 HB	0.50	2.80	0.14	0.31	1.90	0.27	
		Inconel 700	250 HB							
		Stellite 21	350 HB							
Ti based	10	TiAl6V4	-	0.50	2.80	0.14	0.34	1.90	0.31	
		T40	-				0.31		0.27	
Steel	11	X100 CrMo13, 440C, G-X260NiCr42	45 HRc	0.40	1.40	0.12	0.31	1.30	0.24	
			50 HRc		1.10		0.27	0.90	0.22	
			55 HRc		0.90		0.24	0.60	0.20	
		Chilled Cast Iron	Ni-Hard 2		400 HB		1.10	0.31	0.90	0.24
			White Cast Iron		G-X300CrMo15		55 HRc	0.90	0.24	0.60
NF Aluminium	12	AlSi12		130 HB	0.50	4.00	0.22	0.54	2.50	0.43

The depth of cut and feed rate tables are for the geometry and corner radius specified above the table. Refer to cutting speed tables on page 226 for recommended materials per grade.

MACHINING CONDITIONS - MILLING - DEPTH OF CUT AND FEED

ODMW 060508 TN

Material Group	Lamina Gr. N°	Material Examples	Hardness	DOC [mm]		Feed [mm/z]		Suggested Starting Parameters		
				min	max	min	max	DOC	Feed	
P P High Alloyed	1	C35, Ck45, 1020, 1045, 1060, 28Mn6	125 HB	0.50	4.00	0.22	0.58	3.00	0.41	
			190 HB							
			250 HB							
	2	42CrMo4, St50, Ck60, 4140, 4340, 100Cr6	180 HB	0.50	4.00	0.18	0.45	3.00	0.36	
			230 HB				0.40		0.32	
			280 HB							
			350 HB							
	3	X40CrMoV5, H13, M42, D3, S6-5-2, 12Ni19	220 HB	0.50	2.80	0.14	0.40	2.30	0.32	
			280 HB				0.32		0.29	
			320 HB							
			350 HB							
	K Malleable & Nodular	7	GG20, GG40, EN-GJL-250, N030B	150 HB	0.50	4.00	0.22	0.58	3.00	0.41
200 HB										
250 HB										
8		GGG40, GGG70, 50005	150 HB	0.50	4.00	0.18	0.50	3.00	0.36	
			200 HB							
			250 HB							
H Steel Chilled Cast Iron White Cast Iron	11	X100 CrMo13, 440C, G-X260NiCr42	45 HRc	0.40	1.40	0.12	0.32	1.10	0.25	
			50 HRc				1.10	0.29	0.90	0.23
			55 HRc				0.90	0.25	0.70	0.22
		Ni-Hard 2	400 HB				1.10	0.32	0.90	0.25
			55 HRc				0.90	0.25	0.70	0.22
		G-X300CrMo15	400 HB				1.10	0.32	0.90	0.25
			55 HRc				0.90	0.25	0.70	0.22

The depth of cut and feed rate tables are for the geometry and corner radius specified above the table. Refer to cutting speed tables on page 226 for recommended materials per grade.

MACHINING CONDITIONS - MILLING - DEPTH OF CUT AND FEED

OFER 070405 TN
OFMT 070405 TN

Material Group	Lamina Gr. N°	Material Examples	Hardness	DOC [mm]		Feed [mm/z]		Suggested Starting Parameters		
				min	max	min	max	DOC	Feed	
Non Alloyed	1	C35, Ck45, 1020, 1045, 1060, 28Mn6	125 HB	0.50	4.50	0.22	0.51	3.00	0.37	
			190 HB							
			250 HB							
Low Alloyed	2	42CrMo4, St50, Ck60, 4140, 4340, 100Cr6	180 HB	0.50	4.50	0.18	0.40	3.00	0.32	
			230 HB				0.35			
			280 HB							
			350 HB							
High Alloyed	3	X40CrMoV5, H13, M42, D3, S6-5-2, 12Ni19	220 HB	0.50	3.20	0.14	0.35	2.20	0.29	
			280 HB							
			320 HB							
			350 HB							
Austenitic	4	304, 316, X5CrNi18-9	180 HB	0.50	4.50	0.18	0.35	3.00	0.29	
			240 HB				0.14			0.32
Duplex	5	X2CrNiN23-4, S31500	290 HB	0.50	3.20	0.14	0.29	2.20	0.26	
			310 HB							
Ferritic & Martensitic	6	410, X6Cr17, 17-4PH, 430	200 HB	0.50	4.50	0.18	0.35	3.00	0.29	
			42 HRc		3.20		0.32	2.20	0.26	
Grey	7	GG20, GG40, EN-GJL-250, N030B	150 HB	0.50	4.50	0.22	0.51	3.00	0.37	
			200 HB							
			250 HB							
Malleable & Nodular	8	GGG40, GGG70, 50005	150 HB	0.50	4.50	0.18	0.45	3.00	0.32	
			200 HB							
			250 HB							
Fe, Ni & Co based	9	Incoloy 800	240 HB	0.50	3.20	0.14	0.29	2.20	0.26	
		Inconel 700	250 HB							
		Stellite 21	350 HB							
Ti based	10	TiAl6V4	-	0.50	3.20	0.14	0.32	2.20	0.29	
		T40	-				0.29		0.26	
Steel	11	X100 CrMo13, 440C, G-X260NiCr42	45 HRc	0.40	1.60	0.12	0.29	1.50	0.22	
			50 HRc		1.30		0.26	1.10	0.21	
			55 HRc		1.00		0.22	0.70	0.19	
		Chilled Cast Iron	Ni-Hard 2		400 HB		1.30	0.29	1.10	0.22
			White Cast Iron		G-X300CrMo15		55 HRc	1.00	0.22	0.70
Aluminium	12	AlSi12		130 HB	0.50	4.50	0.22	0.51	3.00	0.40

The depth of cut and feed rate tables are for the geometry and corner radius specified above the table. Refer to cutting speed tables on page 226 for recommended materials per grade.

MACHINING CONDITIONS - MILLING - DEPTH OF CUT AND FEED

ONKX 0806-45

Material Group	Lamina Gr. N°	Material Examples	Hardness	DOC [mm]		Feed [mm/z]		Suggested Starting Parameters		
				min	max	min	max	DOC	Feed	
P Non Alloyed Low Alloyed High Alloyed	1	C35, Ck45, 1020, 1045, 1060, 28Mn6	125 HB	0.50	4.00	0.16	0.58	3.00	0.46	
			190 HB							
			250 HB							
	2	42CrMo4, St50, Ck60, 4140, 4340, 100Cr6	180 HB	0.50	4.00	0.14	0.50	3.00	0.40	
			230 HB				0.44		0.36	
			280 HB							
			350 HB							
	3	X40CrMoV5, H13, M42, D3, S6-5-2, 12Ni19	220 HB	0.50	4.00	0.11	0.44	3.00	0.36	
			280 HB				0.36		0.32	
			320 HB							
			350 HB							
	M Austenitic Duplex Ferritic & Martensitic	4	304, 316, X5CrNi18-9	180 HB	0.50	1.50	0.14	1.20	0.34	
240 HB				0.11						
5		X2CrNiN23-4, S31500	290 HB	0.50	1.50	0.11	0.36	1.20	0.30	
			310 HB							
6		410, X6Cr17, 17-4PH, 430	200 HB	0.50	1.50	0.14	0.44	1.20	0.34	
			42 HRc				0.40		0.30	
K Grey Malleable & Nodular	7	GG20, GG40, EN-GJL-250, N030B	150 HB	0.50	4.00	0.17	0.58	4.00	0.46	
			200 HB							
			250 HB							
	8	GGG40, GGG70, 50005	150 HB	0.50	4.00	0.14	0.52	4.00	0.40	
			200 HB							
			250 HB							
S Fe, Ni & Co based Ti based	9	Incoloy 800	240 HB	0.50	1.50	0.11	0.36	1.20	0.30	
		Inconel 700	250 HB							
		Stellite 21	350 HB							
	10	TiAl6V4 T40	-	0.50	1.50	0.11	0.40	1.20	0.34	
			-				0.36		0.30	
			-				-		-	
H Steel Chilled Cast Iron White Cast Iron	11	X100 CrMo13, 440C, G-X260NiCr42	45 HRc	0.40	3.00	0.09	0.36	2.00	0.28	
			50 HRc				0.32	1.00	0.26	
			55 HRc				1.50	0.28	0.50	0.24
			400 HB				3.00	0.36	1.50	0.28
			55 HRc				1.50	0.28	0.50	0.24
			-				-	-	-	-
NF Aluminium	12	AISI12	130 HB	0.50	1.50	0.17	0.60	1.50	0.50	

The depth of cut and feed rate tables are for the geometry and corner radius specified above the table. Refer to cutting speed tables on page 226 for recommended materials per grade.

MACHINING CONDITIONS - MILLING - DEPTH OF CUT AND FEED

RDMT 0602 M0

Material Group	Lamina Gr. N°	Material Examples	Hardness	DOC [mm]		Feed [mm/z]		Suggested Starting Parameters	
				min	max	min	max	DOC	Feed
Non Alloyed	1	C35, Ck45, 1020, 1045, 1060, 28Mn6	125 HB	0.50	1.50	0.18	0.48	0.80	0.29
			190 HB						
			250 HB						
Low Alloyed	2	42CrMo4, St50, Ck60, 4140, 4340, 100Cr6	180 HB	0.50	1.50	0.15	0.38	0.80	0.25
			230 HB				0.33		0.22
			280 HB						
			350 HB						
High Alloyed	3	X40CrMoV5, H13, M42, D3, S6-5-2, 12Ni19	220 HB	0.50	1.10	0.12	0.33	0.60	0.22
			280 HB				0.27		0.20
			320 HB						
			350 HB						
Austenitic	4	304, 316, X5CrNi18-9	180 HB	0.50	1.50	0.15	0.80	0.25	
			240 HB			0.38			
						0.33			
Duplex	5	X2CrNiN23-4, S31500	290 HB	0.50	1.20	0.12	0.27	0.60	0.20
			310 HB						
Ferritic & Martensitic	6	410, X6Cr17, 17-4PH, 430	200 HB	0.50	1.50	0.15	0.38	0.80	0.25
			42 HRc		1.20		0.30		
Grey	7	GG20, GG40, EN-GJL-250, N030B	150 HB	0.50	1.50	0.18	0.48	0.80	0.29
			200 HB						
			250 HB						
Malleable & Nodular	8	GGG40, GGG70, 50005	150 HB	0.50	1.50	0.15	0.42	0.80	0.25
			200 HB						
			250 HB						
Fe, Ni & Co based	9	Incoloy 800	240 HB	0.50	1.20	0.12	0.27	0.60	0.20
		Inconel 700	250 HB						
		Stellite 21	350 HB						
Ti based	10	TiAl6V4	-	0.50	1.20	0.12	0.30	0.60	0.22
		T40	-				0.27		0.20
Steel	11	X100 CrMo13, 440C, G-X260NiCr42	45 HRc	0.30	0.60	0.10	0.27	0.30	0.17
			50 HRc		0.40		0.24		0.16
			55 HRc				0.21		0.15
			400 HB				0.27		0.18
Chilled Cast Iron	Ni-Hard 2	400 HB	0.50			0.21		0.15	
White Cast Iron	G-X300CrMo15	55 HRc				0.21		0.15	
NF Aluminium	12	AlSi12	130 HB	0.50	1.50	0.18	0.48	0.80	0.31

The depth of cut and feed rate tables are for the geometry and corner radius specified above the table. Refer to cutting speed tables on page 226 for recommended materials per grade.

MACHINING CONDITIONS - MILLING - DEPTH OF CUT AND FEED

RDMT 0702 M0

Material Group	Lamina Gr. N°	Material Examples	Hardness	DOC [mm]		Feed [mm/z]		Suggested Starting Parameters		
				min	max	min	max	DOC	Feed	
P Non Alloyed Low Alloyed High Alloyed	1	C35, Ck45, 1020, 1045, 1060, 28Mn6	125 HB	0.50	1.80	0.18	0.54	0.80	0.32	
			190 HB							
			250 HB							
	2	42CrMo4, St50, Ck60, 4140, 4340, 100Cr6	180 HB	0.50	1.80	0.15	0.43	0.80	0.28	
			230 HB				0.37		0.25	
			280 HB							
			350 HB							
	3	X40CrMoV5, H13, M42, D3, S6-5-2, 12Ni19	220 HB	0.50	1.30	0.12	0.37	0.60	0.25	
			280 HB				0.31		0.22	
			320 HB							
			350 HB							
	M Austenitic Duplex Ferritic & Martensitic	4	304, 316, X5CrNi18-9	180 HB	0.50	1.80	0.15	0.80	0.28	
240 HB				0.12						
5		X2CrNiN23-4, S31500	290 HB	0.50	1.40	0.12	0.31	0.60	0.22	
			310 HB							
6		410, X6Cr17, 17-4PH, 430	200 HB	0.50	1.80	0.15	0.43	0.80	0.28	
			42 HRc		1.40		0.34			0.60
K Grey Malleable & Nodular	7	GG20, GG40, EN-GJL-250, N030B	150 HB	0.50	1.80	0.18	0.54	0.80	0.32	
			200 HB							
			250 HB							
	8	GGG40, GGG70, 50005	150 HB	0.50	1.80	0.15	0.48	0.80	0.28	
			200 HB							
			250 HB							
S Fe, Ni & Co based Ti based	9	Incoloy 800	240 HB	0.50	1.40	0.12	0.31	0.60	0.22	
		Inconel 700	250 HB							
		Stellite 21	350 HB							
	10	TiAl6V4	-	0.50	1.40	0.12	0.34	0.60	0.25	
		T40	-				0.31		0.22	
	H Steel Chilled Cast Iron White Cast Iron	11	X100 CrMo13, 440C, G-X260NiCr42	45 HRc	0.30	0.60	0.10	0.31	0.30	0.40
50 HRc				0.50		0.27		0.18		
55 HRc						0.24		0.17		
400 HB						0.31		0.20		
55 HRc						0.24		0.17		
G-X300CrMo15						55 HRc		0.24		0.17
NF Aluminium	12	AISI12	130 HB	0.50	1.80	0.18	0.54	0.80	0.35	

The depth of cut and feed rate tables are for the geometry and corner radius specified above the table. Refer to cutting speed tables on page 226 for recommended materials per grade.

MACHINING CONDITIONS - MILLING - DEPTH OF CUT AND FEED

RDMT 0803 M0

Material Group	Lamina Gr. N°	Material Examples	Hardness	DOC [mm]		Feed [mm/z]		Suggested Starting Parameters	
				min	max	min	max	DOC	Feed
P P High Alloyed	1	C35, Ck45, 1020, 1045, 1060, 28Mn6	125 HB	0.50	2.00	0.18	0.58	0.80	0.34
			190 HB						
			250 HB						
	2	42CrMo4, St50, Ck60, 4140, 4340, 100Cr6	180 HB	0.50	2.00	0.15	0.45	0.80	0.30
			230 HB						
			280 HB						
			350 HB						
	3	X40CrMoV5, H13, M42, D3, S6-5-2, 12Ni19	220 HB	0.50	1.40	0.12	0.40	0.60	0.27
			280 HB						
			320 HB						
			350 HB						
	M Austenitic Duplex Ferritic & Martensitic	4	304, 316, X5CrNi18-9	180 HB	0.50	2.00	0.15	0.80	0.30
240 HB				0.45					
5		X2CrNiN23-4, S31500	290 HB	0.50	1.50	0.12	0.32	0.60	0.24
			310 HB						
6		410, X6Cr17, 17-4PH, 430	200 HB	0.50	2.00	0.15	0.45	0.80	0.30
			42 HRc		1.50		0.36		
K Grey Malleable & Nodular	7	GG20, GG40, EN-GJL-250, N030B	150 HB	0.50	2.00	0.18	0.58	0.80	0.34
			200 HB						
			250 HB						
	8	GGG40, GGG70, 50005	150 HB	0.50	2.00	0.15	0.50	0.80	0.30
			200 HB						
			250 HB						
S Fe, Ni & Co based Ti based	9	Incoloy 800	0.50	1.50	0.12	0.32	0.60	0.24	
		Inconel 700							
		Stellite 21							
	10	TiAl6V4	0.50	1.50	0.12	0.36	0.60	0.27	
		T40				0.32		0.24	
	H Steel Chilled Cast Iron White Cast Iron	11	X100 CrMo13, 440C, G-X260NiCr42	45 HRc	0.30	0.70	0.10	0.32	0.30
50 HRc				0.60		0.29		0.19	
55 HRc				0.50		0.25		0.18	
Ni-Hard 2			400 HB	0.60		0.32		0.21	
			G-X300CrMo15	55 HRc		0.50		0.25	
NF Aluminium				12		AlSi12		130 HB	

The depth of cut and feed rate tables are for the geometry and corner radius specified above the table. Refer to cutting speed tables on page 226 for recommended materials per grade.

MACHINING CONDITIONS - MILLING - DEPTH OF CUT AND FEED

RDMT 1003 M0
RDMT 10T3 M0

RDMX 1003 M0
RDMX 10T3 M0

RXMT 10T3 M0
RXMX 10T3 M0

Material Group	Lamina Gr. N°	Material Examples	Hardness	DOC [mm]		Feed [mm/z]		Suggested Starting Parameters							
				min	max	min	max	DOC	Feed						
P Non Alloyed Low Alloyed High Alloyed	1	C35, Ck45, 1020, 1045, 1060, 28Mn6	125 HB	0.50	2.50	0.18	0.64	1.00	0.34						
			190 HB												
			250 HB												
	2	42CrMo4, St50, Ck60, 4140, 4340, 100Cr6	180 HB	0.50	2.50	0.15	0.50	1.00	0.30						
			230 HB												
			280 HB				0.44		0.27						
			350 HB												
	3	X40CrMoV5, H13, M42, D3, S6-5-2, 12Ni19	220 HB	0.50	1.80	0.12	0.44	0.80	0.27						
			280 HB												
			320 HB				0.36		0.24						
			350 HB												
	M Austenitic Duplex Ferritic & Martensitic	4	304, 316, X5CrNi18-9	180 HB	0.50	2.50	0.15	0.50	1.00	0.30					
240 HB															
5		X2CrNiN23-4, S31500	290 HB	0.50	2.00	0.12	0.36	0.80	0.24						
			310 HB												
6		410, X6Cr17, 17-4PH, 430	200 HB	0.50	2.50	0.15	0.50	1.00	0.30						
			42 HRc		2.00					0.40	0.80	0.24			
K Grey Malleable & Nodular	7	GG20, GG40, EN-GJL-250, N030B	150 HB	0.50	2.50	0.18	0.64	1.00	0.34						
			200 HB												
			250 HB												
	8	GGG40, GGG70, 50005	150 HB	0.50	2.50	0.15	0.56	1.00	0.30						
			200 HB												
			250 HB												
S Fe, Ni & Co based Ti based	9	Incoloy 800	0.50	2.00	0.12	0.36	0.80	0.24							
		Inconel 700													
		Stellite 21													
	10	TiAl6V4	0.50	2.00	0.12	0.40	0.80	0.27							
		T40							0.36	0.24					
	H Steel Chilled Cast Iron White Cast Iron	11	X100 CrMo13, 440C, G-X260NiCr42	45 HRc	0.30	0.90	0.10	0.36	0.50	0.21					
50 HRc															
55 HRc															
Ni-Hard 2			400 HB	0.70				0.36	0.40	0.21					
			G-X300CrMo15								55 HRc	0.60	0.28	0.30	0.18
NF Aluminium	12	AISI12	130 HB	0.50	2.50	0.18	0.64	1.00	0.38						

The depth of cut and feed rate tables are for the geometry and corner radius specified above the table. Refer to cutting speed tables on page 226 for recommended materials per grade.

MACHINING CONDITIONS - MILLING - DEPTH OF CUT AND FEED

RDMT 1204 M0
RDMT 12T3 M0

RDMX 1204 M0
RDMX 12T3 M0

RXMT 1204 M0
RXMX 1204 M0

Material Group	Lamina Gr. N°	Material Examples	Hardness	DOC [mm]		Feed [mm/z]		Suggested Starting Parameters		
				min	max	min	max	DOC	Feed	
Non Alloyed	1	C35, Ck45, 1020, 1045, 1060, 28Mn6	125 HB	0.50	3.00	0.25	0.74	1.30	0.34	
			190 HB							
			250 HB							
Low Alloyed	2	42CrMo4, St50, Ck60, 4140, 4340, 100Cr6	180 HB	0.50	3.00	0.21	0.57	1.30	0.30	
			230 HB				0.51			
			280 HB							
			350 HB							
High Alloyed	3	X40CrMoV5, H13, M42, D3, S6-5-2, 12Ni19	220 HB	0.50	2.20	0.17	0.51	1.00	0.27	
			280 HB							
			320 HB							
			350 HB							
Austenitic	4	304, 316, X5CrNi18-9	180 HB	0.50	3.00	0.21	0.57	1.30	0.30	
			240 HB				0.17			
Duplex	5	X2CrNiN23-4, S31500	290 HB	0.50	2.40	0.17	0.41	1.00	0.24	
			310 HB							
Ferritic & Martensitic	6	410, X6Cr17, 17-4PH, 430	200 HB	0.50	3.00	0.21	0.57	1.30	0.30	
			42 HRc		2.40		0.46			
Grey	7	GG20, GG40, EN-GJL-250, N030B	150 HB	0.50	3.00	0.25	0.74	1.30	0.34	
			200 HB							
			250 HB							
Malleable & Nodular	8	GGG40, GGG70, 50005	150 HB	0.50	3.00	0.21	0.64	1.30	0.30	
			200 HB							
			250 HB							
Fe, Ni & Co based	9	Incoloy 800	240 HB	0.50	2.40	0.17	0.41	1.00	0.24	
		Inconel 700	250 HB							
		Stellite 21	350 HB							
Ti based	10	TiAl6V4	-	0.50	2.40	0.17	0.46	1.00	0.27	
		T40	-				0.41		0.24	
Steel	11	X100 CrMo13, 440C, G-X260NiCr42	45 HRc	0.30	1.10	0.14	0.41	0.70	0.21	
			50 HRc		0.90		0.37	0.50	0.19	
			55 HRc		0.80		0.32	0.30	0.18	
		Chilled Cast Iron	Ni-Hard 2		400 HB		0.90	0.41	0.50	0.21
			White Cast Iron		G-X300CrMo15		55 HRc	0.80	0.32	0.30
Aluminium	12	AlSi12		130 HB	0.50	3.00	0.25	0.74	1.30	0.38

The depth of cut and feed rate tables are for the geometry and corner radius specified above the table. Refer to cutting speed tables on page 226 for recommended materials per grade.

MACHINING CONDITIONS - MILLING - DEPTH OF CUT AND FEED

RDMT 1604 M0

Material Group	Lamina Gr. N°	Material Examples	Hardness	DOC [mm]		Feed [mm/z]		Suggested Starting Parameters				
				min	max	min	max	DOC	Feed			
P	Non Alloyed	C35, Ck45, 1020, 1045, 1060, 28Mn6	125 HB	0.50	4.00	0.25	1.00	2.00	0.34			
			190 HB									
			250 HB									
	Low Alloyed	2	42CrMo4, St50, Ck60, 4140, 4340, 100Cr6	180 HB	0.50	4.00	0.21	0.78	2.00	0.30		
				230 HB				0.69		0.27		
				280 HB								
				350 HB								
	High Alloyed	3	X40CrMoV5, H13, M42, D3, S6-5-2, 12Ni19	220 HB	0.50	2.80	0.17	0.69	1.50	0.27		
				280 HB				0.56		0.24		
				320 HB								
				350 HB								
	M	Austenitic	4	304, 316, X5CrNi18-9	180 HB	0.50	4.00	0.21	2.00	0.30		
240 HB					0.17							
Duplex		5	X2CrNiN23-4, S31500	290 HB	0.50	3.10	0.17	0.56	1.50	0.24		
				310 HB								
Ferritic & Martensitic		6	410, X6Cr17, 17-4PH, 430	200 HB	0.50	4.00	0.21	0.78	2.00	0.30		
				42 HRc		3.10		0.63			1.50	0.24
K	Grey	7	GG20, GG40, EN-GJL-250, N030B	150 HB	0.50	4.00	0.25	1.00	2.00	0.34		
				200 HB								
				250 HB								
	Malleable & Nodular	8	GGG40, GGG70, 50005	150 HB	0.50	4.00	0.21	0.88	2.00	0.30		
200 HB												
250 HB												
S	Fe, Ni & Co based	9	Incoloy 800	0.50	3.10	0.17	0.56	1.50	0.24			
			Inconel 700									
			Stellite 21									
	Ti based	10	TiAl6V4	0.50	3.10	0.17	0.63	1.50	0.27			
			T40				0.56		0.24			
H	Steel	11	X100 CrMo13, 440C,	0.40	1.40	0.14	0.56	1.00	0.21			
			G-X260NiCr42				50 HRc		1.10	0.50	0.80	0.19
							55 HRc		1.00	0.44	0.50	0.18
			Ni-Hard 2				400 HB		1.10	0.56	0.80	0.21
			G-X300CrMo15				55 HRc		1.00	0.44	0.50	0.18
White Cast Iron												
NF	Aluminium	12	AISI12	130 HB	0.50	4.00	0.25	1.00	2.00	0.38		

The depth of cut and feed rate tables are for the geometry and corner radius specified above the table. Refer to cutting speed tables on page 226 for recommended materials per grade.

MACHINING CONDITIONS - MILLING - DEPTH OF CUT AND FEED

RDMW 1003 M0

RDMW 10T3 M0

RXMW 10T3 M0

Material Group	Lamina Gr. N°	Material Examples	Hardness	DOC [mm]		Feed [mm/z]		Suggested Starting Parameters								
				min	max	min	max	DOC	Feed							
P Non Alloyed Low Alloyed High Alloyed	1	C35, Ck45, 1020, 1045, 1060, 28Mn6	125 HB	0.50	2.50	0.18	0.70	1.00	0.39							
			190 HB													
			250 HB													
	2	42CrMo4, St50, Ck60, 4140, 4340, 100Cr6	180 HB	0.50	2.50	0.15	0.55	1.00	0.34							
			230 HB													
			280 HB													
			350 HB													
	3	X40CrMoV5, H13, M42, D3, S6-5-2, 12Ni19	220 HB	0.50	1.80	0.12	0.48	0.80	0.31							
			280 HB													
320 HB																
350 HB																
K Grey Malleable & Nodular	7	GG20, GG40, EN-GJL-250, N030B	150 HB	0.50	2.50	0.18	0.70	1.00	0.39							
			200 HB													
			250 HB													
8	GGG40, GGG70, 50005	150 HB	0.50	2.50	0.15	0.62	1.00	0.34								
		200 HB														
		250 HB														
H Steel Chilled Cast Iron White Cast Iron	11	X100 CrMo13, 440C, G-X260NiCr42	45 HRc	0.30	0.90	0.10	0.40	0.50	0.24							
			50 HRc													
			55 HRc													
		Ni-Hard 2	400 HB				0.70			0.31	0.30	0.20				
			G-X300CrMo15							400 HB			0.70	0.40	0.40	0.24
										55 HRc				0.60		

RDMW 1204 M0

RDMW 12T3 M0

RXMW 1204 M0

Material Group	Lamina Gr. N°	Material Examples	Hardness	DOC [mm]		Feed [mm/z]		Suggested Starting Parameters						
				min	max	min	max	DOC	Feed					
P Non Alloyed Low Alloyed High Alloyed	1	C35, Ck45, 1020, 1045, 1060, 28Mn6	125 HB	0.30	4.00	0.27	0.70	1.50	0.60					
			190 HB				0.65		0.60					
			250 HB				0.50		0.50					
	2	42CrMo4, St50, Ck60, 4140, 4340, 100Cr6	180 HB	0.30	4.00	0.25	0.65	1.50	0.60					
			230 HB				0.57		0.55					
			280 HB				0.52		0.50					
			350 HB				0.50		1.00	0.50				
	3	X40CrMoV5, H13, M42, D3, S6-5-2, 12Ni19	220 HB	0.30	2.00	0.20	0.57	1.00	0.55					
			280 HB				0.52		0.50					
			320 HB				0.50		0.50					
			350 HB				0.47		0.45					
	K Grey Malleable & Nodular	7	GG20, GG40, EN-GJL-250, N030B	150 HB	0.30	3.00	0.20	0.80	2.00	0.80				
200 HB				0.70										
250 HB				0.60										
8	GGG40, GGG70, 50005	150 HB	0.30	2.50	0.20	0.60	1.50	0.50						
		200 HB						0.55						
		250 HB						0.60						
H Steel Chilled Cast Iron White Cast Iron	11	X100 CrMo13, 440C, G-X260NiCr42	45 HRc	0.30	1.00	0.18	0.38	0.50	0.38					
			50 HRc				0.34		0.34					
			55 HRc				0.30		0.30					
		Ni-Hard 2	400 HB				1.00		0.38	0.38	0.38			
			G-X300CrMo15						400 HB			1.00	0.38	0.38
									55 HRc				0.50	

The depth of cut and feed rate tables are for the geometry and corner radius specified above the table. Refer to cutting speed tables on page 226 for recommended materials per grade.

MACHINING CONDITIONS - MILLING - DEPTH OF CUT AND FEED

SDKT 1204 AETN

Material Group	Lamina Gr. N°	Material Examples	Hardness	DOC [mm]		Feed [mm/z]		Suggested Starting Parameters	
				min	max	min	max	DOC	Feed
Non Alloyed P Low Alloyed High Alloyed	1	C35, Ck45, 1020, 1045, 1060, 28Mn6	125 HB	0.50	7.00	0.18	0.53	3.00	0.39
			190 HB						
			250 HB						
	2	42CrMo4, St50, Ck60, 4140, 4340, 100Cr6	180 HB	0.50	7.00	0.15	0.41	3.00	0.34
			230 HB				0.36		0.31
			280 HB						
			350 HB						
	3	X40CrMoV5, H13, M42, D3, S6-5-2, 12Ni19	220 HB	0.50	5.00	0.12	0.36	2.30	0.31
			280 HB				0.30		0.27
			320 HB						
			350 HB						
	Austenitic M Duplex Ferritic & Martensitic	4	304, 316, X5CrNi18-9	180 HB	0.50	7.00	0.15	0.36	3.00
240 HB				0.12					
5		X2CrNiN23-4, S31500	290 HB	0.50	5.00	0.12	0.30	2.30	0.27
			310 HB						
6		410, X6Cr17, 17-4PH, 430	200 HB	0.50	7.00	0.15	0.36	3.00	0.31
			42 HRc		5.00		0.30		
Grey K Malleable & Nodular	7	GG20, GG40, EN-GJL-250, N030B	150 HB	0.50	7.00	0.18	0.53	3.00	0.39
			200 HB						
			250 HB						
	8	GGG40, GGG70, 50005	150 HB	0.50	7.00	0.15	0.46	3.00	0.34
			200 HB						
			250 HB						
Fe, Ni & Co based S Ti based	9	Incoloy 800	240 HB	0.50	5.00	0.12	0.30	2.30	0.27
		Inconel 700	250 HB						
		Stellite 21	350 HB						
	10	TiAl6V4	-	0.50	5.00	0.12	0.33	2.30	0.31
		T40	-				0.30		0.27
	Steel H Chilled Cast Iron White Cast Iron	11	X100 CrMo13, 440C, G-X260NiCr42	45 HRc	0.50	2.50	0.10	0.30	1.50
50 HRc				1.80		0.26		1.10	0.22
55 HRc				1.50		0.23		0.80	0.20
Ni-Hard 2			400 HB	2.00		0.30		1.10	0.24
			G-X300CrMo15	55 HRc		1.50		0.23	0.80
NF Aluminium				12		AISI12		130 HB	0.50

The depth of cut and feed rate tables are for the geometry and corner radius specified above the table. Refer to cutting speed tables on page 226 for recommended materials per grade.

MACHINING CONDITIONS - MILLING - DEPTH OF CUT AND FEED

SDKW 0904-HF

Material Group	Lamina Gr. N°	Material Examples	Hardness	DOC [mm]		Feed [mm/z]		Suggested Starting Parameters								
				min	max	min	max	DOC	Feed							
P Non Alloyed Low Alloyed High Alloyed	1	C35, Ck45, 1020, 1045, 1060, 28Mn6	125 HB	0.30	1.50	0.30	1.50	1.10	1.30							
			190 HB					1.00								
			250 HB													
	2	42CrMo4, St50, Ck60, 4140, 4340, 100Cr6	180 HB	0.30	1.30	0.30	1.36	0.80	1.10							
			230 HB						1.00							
			280 HB													
			350 HB													
	3	X40CrMoV5, H13, M42, D3, S6-5-2, 12Ni19	220 HB	0.30	1.30	0.30	1.20	0.70	0.90							
			280 HB						1.20							
			320 HB						1.10							
			350 HB													
	K Grey Malleable & Nodular	7	GG20, GG40, EN-GJL-250, N030B	150 HB	0.30	1.50	0.30	2.26	1.20	1.30						
200 HB																
250 HB																
8		GGG40, GGG70, 50005	150 HB	0.30	1.50	0.30	1.36	1.20	1.10							
			200 HB													
			250 HB													
H Steel Chilled Cast Iron White Cast Iron	11	X100 CrMo13, 440C, G-X260NiCr42	45 HRc	0.30	0.60	0.30	0.90	0.60	0.60							
			50 HRc						0.76							
			55 HRc						0.50							
			400 HB							0.40						
			Ni-Hard 2						400 HB	55 HRc	0.30	0.60	0.30	0.60	0.40	0.50
																0.40

SDKW 1205-HF

Material Group	Lamina Gr. N°	Material Examples	Hardness	DOC [mm]		Feed [mm/z]		Suggested Starting Parameters								
				min	max	min	max	DOC	Feed							
P Non Alloyed Low Alloyed High Alloyed	1	C35, Ck45, 1020, 1045, 1060, 28Mn6	125 HB	0.30	2.00	0.30	2.70	1.30	1.70							
			190 HB													
			250 HB													
	2	42CrMo4, St50, Ck60, 4140, 4340, 100Cr6	180 HB	0.30	1.60	0.30	2.50	1.00	1.50							
			230 HB						1.40							
			280 HB													
			350 HB													
	3	X40CrMoV5, H13, M42, D3, S6-5-2, 12Ni19	220 HB	0.30	1.60	0.30	2.25	0.80	1.20							
			280 HB						1.30							
			320 HB						1.10							
			350 HB													
	K Grey Malleable & Nodular	7	GG20, GG40, EN-GJL-250, N030B	150 HB	0.30	2.00	0.30	2.70	1.60	1.70						
200 HB																
250 HB																
8		GGG40, GGG70, 50005	150 HB	0.30	2.00	0.30	2.25	1.60	1.60							
			200 HB													
			250 HB													
H Steel Chilled Cast Iron White Cast Iron	11	X100 CrMo13, 440C, G-X260NiCr42	45 HRc	0.30	0.80	0.30	1.25	0.70	0.80							
			50 HRc						0.70							
			55 HRc						0.60							
			400 HB							0.90						
			Ni-Hard 2						400 HB	55 HRc	0.30	0.70	0.30	0.80	0.40	0.60
																0.60

The depth of cut and feed rate tables are for the geometry and corner radius specified above the table. Refer to cutting speed tables on page 226 for recommended materials per grade.

MACHINING CONDITIONS - MILLING - DEPTH OF CUT AND FEED

SDKX 0904-HF

Material Group	Lamina Gr. N°	Material Examples	Hardness	DOC [mm]		Feed [mm/z]		Suggested Starting Parameters	
				min	max	min	max	DOC	Feed
Non Alloyed P Low Alloyed High Alloyed	1	C35, Ck45, 1020, 1045, 1060, 28Mn6	125 HB	0.30	1.50	0.30	1.50	1.00	1.20
			190 HB						
			250 HB						
	2	42CrMo4, St50, Ck60, 4140, 4340, 100Cr6	180 HB	0.30	1.20	0.30	1.36	0.80	1.00
			230 HB						
			280 HB						
			350 HB						
	3	X40CrMoV5, H13, M42, D3, S6-5-2, 12Ni19	220 HB	0.30	1.20	0.30	1.20	0.70	0.80
			280 HB		1.10				
			320 HB		1.00				
			350 HB						
	Austenitic M Duplex Ferritic & Martensitic	4	304, 316, X5CrNi18-9	180 HB	0.30	1.30	0.30	0.76	0.80
240 HB									
5		X2CrNiN23-4, S31500	290 HB	0.30	1.10	0.30	0.46	0.70	0.30
			310 HB						
6		410, X6Cr17, 17-4PH, 430	200 HB	0.30	1.20	0.30	0.52	0.80	0.40
			42 HRc		1.00		0.46		
Grey K Malleable & Nodular	7	GG20, GG40, EN-GJL-250, N030B	150 HB	0.30	1.50	0.30	2.26	1.20	1.20
			200 HB				1.50		
			250 HB				1.50		
	8	GGG40, GGG70, 50005	150 HB	0.30	1.50	0.30	1.36	1.20	1.00
			200 HB						
			250 HB						
Fe, Ni & Co based S Ti based	9	Incoloy 800	0.30	1.40	0.30	0.60	0.80	0.30	
		Inconel 700							
		Stellite 21							
10	TiAl6V4	-	0.30	1.40	0.30	0.52	0.80	0.30	
	T40	-		1.50					
Steel H Chilled Cast Iron White Cast Iron	11	X100 CrMo13, 440C, G-X260NiCr42	45 HRc	0.30	0.50	0.30	0.90	0.60	0.50
			50 HRc				0.76	0.50	
			55 HRc				0.60	0.40	
		Ni-Hard 2	400 HB						0.50
		G-X300CrMo15	55 HRc						0.40
NF Aluminium	12	AISI12	130 HB	0.30	1.50	0.30	0.76	1.50	0.70

The depth of cut and feed rate tables are for the geometry and corner radius specified above the table. Refer to cutting speed tables on page 226 for recommended materials per grade.

MACHINING CONDITIONS - MILLING - DEPTH OF CUT AND FEED

SDKX 1205-HF

Material Group	Lamina Gr. N°	Material Examples	Hardness	DOC [mm]		Feed [mm/z]		Suggested Starting Parameters	
				min	max	min	max	DOC	Feed
P P High Alloyed	1	C35, Ck45, 1020, 1045, 1060, 28Mn6	125 HB	0.30	2.00	0.30	2.70	1.20	1.70
			190 HB						
			250 HB						
	2	42CrMo4, St50, Ck60, 4140, 4340, 100Cr6	180 HB	0.30	1.60	0.30	2.50	0.90	1.50
			230 HB						
			280 HB				2.25		1.40
			350 HB						
	3	X40CrMoV5, H13, M42, D3, S6-5-2, 12Ni19	220 HB	0.30	1.60	0.30	2.25	0.70	1.20
			280 HB		1.30		2.00		
			320 HB		1.10		1.80		1.00
			350 HB				1.60		
	M M M	4	304, 316, X5CrNi18-9	180 HB	0.30	1.50	0.30	1.00	0.90
240 HB									
5		X2CrNiN23-4, S31500	290 HB	0.30	1.20	0.30	0.65	0.80	0.50
			310 HB						
6		410, X6Cr17, 17-4PH, 430	200 HB	0.30	1.50	0.30	0.70	0.90	0.60
			42 HRc		1.10		0.65		
K K K	7	GG20, GG40, EN-GJL-250, N030B	150 HB	0.30	2.00	0.30	2.70	1.50	1.70
			200 HB						
			250 HB						
	8	GGG40, GGG70, 50005	150 HB	0.30	2.00	0.30	2.25	1.50	1.60
			200 HB						
			250 HB						
S S S	9	Incoloy 800	0.30	1.80	0.30	0.90	1.00	0.50	
		Inconel 700				0.80			
		Stellite 21				0.80			
	10	TiAl6V4	0.30	1.80	0.30	0.90	1.00	0.50	
		T40		2.00		0.80			
	H H H	11	X100 CrMo13, 440C, G-X260NiCr42	0.30	0.30	0.30	1.25	0.60	0.80
0.80							0.50		
0.70									
Ni-Hard 2			400 HB				0.70	0.40	0.60
			G-X300CrMo15				55 HRc		
NF			Aluminium				AISi12	130 HB	0.30

The depth of cut and feed rate tables are for the geometry and corner radius specified above the table. Refer to cutting speed tables on page 226 for recommended materials per grade.

MACHINING CONDITIONS - MILLING - DEPTH OF CUT AND FEED

SEKN 1203 AFTN
SEKN 1204 AFTN

SEKR 1203 AFTN
SEKR 1204 AFTN

Material Group	Lamina Gr. N°	Material Examples	Hardness	DOC [mm]		Feed [mm/z]		Suggested Starting Parameters	
				min	max	min	max	DOC	Feed
P Non Alloyed Low Alloyed High Alloyed	1	C35, Ck45, 1020, 1045, 1060, 28Mn6	125 HB	0.50	7.00	0.18	0.46	3.00	0.34
			190 HB						
			250 HB						
	2	42CrMo4, St50, Ck60, 4140, 4340, 100Cr6	180 HB	0.50	7.00	0.15	0.36	3.00	0.30
			230 HB						
			280 HB				0.32		0.27
			350 HB						
	3	X40CrMoV5, H13, M42, D3, S6-5-2, 12Ni19	220 HB	0.50	5.00	0.12	0.32	2.30	0.27
			280 HB						
			320 HB				0.26		0.24
			350 HB						
	M Austenitic Duplex Ferritic & Martensitic	4	304, 316, X5CrNi18-9	180 HB	0.50	7.00	0.15	0.32	3.00
240 HB									
5		X2CrNiN23-4, S31500	290 HB	0.50	5.00	0.12	0.26	2.30	0.24
			310 HB						
6		410, X6Cr17, 17-4PH, 430	200 HB	0.50	7.00	0.15	0.32	3.00	0.27
			42 HRc		5.00				
K Grey Malleable & Nodular	7	GG20, GG40, EN-GJL-250, N030B	150 HB	0.50	7.00	0.18	0.46	3.00	0.34
			200 HB						
			250 HB						
	8	GGG40, GGG70, 50005	150 HB	0.50	7.00	0.15	0.41	3.00	0.30
			200 HB						
			250 HB						
S Fe, Ni & Co based Ti based	9	Incoloy 800	0.50	5.00	0.12	0.26	2.30	0.24	
		Inconel 700							
		Stellite 21							
	10	TiAl6V4	0.50	5.00	0.12	0.29	2.30	0.27	
		T40							
		-							
H Steel Chilled Cast Iron White Cast Iron	11	X100 CrMo13, 440C, G-X260NiCr42	45 HRc	0.50	2.50	0.10	0.26	1.50	0.21
			50 HRc		1.80		0.23	1.10	0.19
			55 HRc		1.50		0.20	0.80	0.18
		Ni-Hard 2	400 HB		2.00		0.26	1.10	0.21
			G-X300CrMo15		55 HRc		1.50	0.20	0.80
		NF Aluminium			12		AISI12	130 HB	0.50

The depth of cut and feed rate tables are for the geometry and corner radius specified above the table. Refer to cutting speed tables on page 226 for recommended materials per grade.

MACHINING CONDITIONS - MILLING - DEPTH OF CUT AND FEED

SEKN 1504 AFTN

Material Group	Lamina Gr. N°	Material Examples	Hardness	DOC [mm]		Feed [mm/z]		Suggested Starting Parameters		
				min	max	min	max	DOC	Feed	
Non Alloyed	1	C35, Ck45, 1020, 1045, 1060, 28Mn6	125 HB	0.50	9.00	0.18	0.50	4.00	0.37	
			190 HB							
			250 HB							
P Low Alloyed	2	42CrMo4, St50, Ck60, 4140, 4340, 100Cr6	180 HB	0.50	9.00	0.15	0.39	4.00	0.32	
			230 HB				0.34			
			280 HB							
			350 HB							
High Alloyed	3	X40CrMoV5, H13, M42, D3, S6-5-2, 12Ni19	220 HB	0.50	6.40	0.12	0.34	3.00	0.29	
			280 HB				0.28			
			320 HB							
			350 HB							
Austenitic	4	304, 316, X5CrNi18-9	180 HB	0.50	9.00	0.15	0.34	4.00	0.29	
			240 HB				0.12			0.31
M Duplex	5	X2CrNiN23-4, S31500	290 HB	0.50	6.40	0.12	0.28	3.00	0.26	
			310 HB							
Ferritic & Martensitic	6	410, X6Cr17, 17-4PH, 430	200 HB	0.50	9.00	0.15	0.34	4.00	0.29	
			42 HRc		6.40		0.28			3.00
K Grey	7	GG20, GG40, EN-GJL-250, N030B	150 HB	0.50	9.00	0.18	0.50	4.00	0.37	
			200 HB							
			250 HB							
Malleable & Nodular	8	GGG40, GGG70, 50005	150 HB	0.50	9.00	0.15	0.43	4.00	0.32	
			200 HB							
			250 HB							
S Fe, Ni & Co based	9	Incoloy 800	240 HB	0.50	6.40	0.12	0.28	3.00	0.26	
		Inconel 700	250 HB							
		Stellite 21	350 HB							
Ti based	10	TiAl6V4	-	0.50	6.40	0.12	0.31	3.00	0.29	
		T40	-				0.28		0.26	
H Steel	11	X100 CrMo13, 440C, G-X260NiCr42	45 HRc	0.50	3.20	0.10	0.28	2.00	0.22	
			50 HRc		1.90		0.25	1.50	0.21	
			55 HRc		1.60		0.22	1.00	0.19	
		Chilled Cast Iron	Ni-Hard 2		400 HB		2.60	0.28	1.50	0.22
			White Cast Iron		G-X300CrMo15		55 HRc	1.60	0.22	1.00
NF Aluminium	12	AlSi12		130 HB	0.50	9.00	0.18	0.50	4.00	0.40

The depth of cut and feed rate tables are for the geometry and corner radius specified above the table. Refer to cutting speed tables on page 226 for recommended materials per grade.

MACHINING CONDITIONS - MILLING - DEPTH OF CUT AND FEED

SEKT 1204 AFTN
SEKT 12T3 AGSN

Material Group	Lamina Gr. N°	Material Examples	Hardness	DOC [mm]		Feed [mm/z]		Suggested Starting Parameters	
				min	max	min	max	DOC	Feed
Non Alloyed P Low Alloyed High Alloyed	1	C35, Ck45, 1020, 1045, 1060, 28Mn6	125 HB	0.50	6.00	0.18	0.46	3.00	0.34
			190 HB						
			250 HB						
	2	42CrMo4, St50, Ck60, 4140, 4340, 100Cr6	180 HB	0.50	6.00	0.15	0.36	3.00	0.30
			230 HB				0.32		0.27
			280 HB						
			350 HB						
	3	X40CrMoV5, H13, M42, D3, S6-5-2, 12Ni19	220 HB	0.50	5.00	0.12	0.32	2.30	0.27
			280 HB				0.26		0.24
320 HB									
350 HB									
Austenitic M Duplex Ferritic & Martensitic	4	304, 316, X5CrNi18-9	180 HB	0.50	6.00	0.15	0.32	3.00	0.27
			240 HB			0.12			
	5	X2CrNiN23-4, S31500	290 HB	0.50	5.00	0.12	0.26	2.30	0.24
			310 HB						
	6	410, X6Cr17, 17-4PH, 430	200 HB	0.50	6.00	0.15	0.32	3.00	0.27
			42 HRc		5.00		0.26		
Grey K Malleable & Nodular	7	GG20, GG40, EN-GJL-250, N030B	150 HB	0.50	6.00	0.18	0.46	3.00	0.34
			200 HB						
			250 HB						
	8	GGG40, GGG70, 50005	150 HB	0.50	6.00	0.15	0.41	3.00	0.30
			200 HB						
			250 HB						
Fe, Ni & Co based S Ti based	9	Incoloy 800	240 HB	0.50	5.00	0.12	0.26	2.30	0.24
		Inconel 700	250 HB						
		Stellite 21	350 HB						
	10	TiAl6V4	-	0.50	5.00	0.12	0.29	2.30	0.27
T40		-	0.26				2.30	0.24	
Steel H Chilled Cast Iron White Cast Iron	11	X100 CrMo13, 440C, G-X260NiCr42	45 HRc	0.50	2.50	0.10	0.26	1.50	0.21
			50 HRc		1.80		0.23	1.10	0.19
			55 HRc		1.50		0.20	0.80	0.18
		Ni-Hard 2	400 HB	0.50	2.00		0.26	1.10	0.21
		G-X300CrMo15	55 HRc	0.50	1.50		0.20	0.80	0.18
NF Aluminium	12	AlSi12	130 HB	0.50	6.00	0.18	0.46	3.00	0.37

The depth of cut and feed rate tables are for the geometry and corner radius specified above the table. Refer to cutting speed tables on page 226 for recommended materials per grade.

MACHINING CONDITIONS - MILLING - DEPTH OF CUT AND FEED

SNKX 1205-45

Material Group	Lamina Gr. N°	Material Examples	Hardness	DOC [mm]		Feed [mm/z]		Suggested Starting Parameters		
				min	max	min	max	DOC	Feed	
P Non Alloyed Low Alloyed High Alloyed	1	C35, Ck45, 1020, 1045, 1060, 28Mn6	125 HB	0.50	5.00	0.16	0.34	3.00	0.30	
			190 HB							
			250 HB							
	2	42CrMo4, St50, Ck60, 4140, 4340, 100Cr6	180 HB	0.50	5.00	0.14	0.28	3.00	0.26	
			230 HB				0.26		0.24	
			280 HB							
			350 HB							
	3	X40CrMoV5, H13, M42, D3, S6-5-2, 12Ni19	220 HB	0.50	5.00	0.11	0.28	3.00	0.26	
			280 HB				0.24		0.22	
320 HB										
350 HB										
M Austenitic Duplex Ferritic & Martensitic	4	304, 316, X5CrNi18-9	180 HB	0.50	5.00	0.14	0.30	3.00	0.26	
			240 HB			0.11				
	5	X2CrNiN23-4, S31500	290 HB	0.50	4.00	0.11	0.25	2.50	0.22	
			310 HB							
	6	410, X6Cr17, 17-4PH, 430	200 HB	0.50	5.00	0.14	0.30	3.00	0.26	
			42 HRc		4.00		0.25		0.22	
K Grey Malleable & Nodular	7	GG20, GG40, EN-GJL-250, N030B	150 HB	0.50	5.00	0.17	0.34	3.00	0.30	
			200 HB							
			250 HB							
	8	GGG40, GGG70, 50005	150 HB	0.50	5.00	0.14	0.30	3.00	0.27	
			200 HB							
			250 HB							
S Fe, Ni & Co based Ti based	9	Incoloy 800	0.50	4.00	0.11	0.20	2.50	0.18		
		Inconel 700								
		Stellite 21								
	10	TiAl6V4	0.50	4.00	0.11	0.25	2.50	0.23		
		T40				0.23		0.20		
		-				-				
H Steel Chilled Cast Iron White Cast Iron	11	X100 CrMo13, 440C, G-X260NiCr42	45 HRc	0.40	2.00	0.10	0.22	1.30	0.18	
			50 HRc				0.20		0.16	
			55 HRc				0.18		0.15	
		Ni-Hard 2	400 HB		2.00		0.22	1.30	0.19	
			G-X300CrMo15				55 HRc		0.20	0.17
							55 HRc		0.20	0.17
NF Aluminium	12	AlSi12	130 HB	0.50	5.00	0.17	0.36	3.00	0.30	

The depth of cut and feed rate tables are for the geometry and corner radius specified above the table. Refer to cutting speed tables on page 226 for recommended materials per grade.

MACHINING CONDITIONS - MILLING - DEPTH OF CUT AND FEED

SNKX 1607-45

Material Group	Lamina Gr. N°	Material Examples	Hardness	DOC [mm]		Feed [mm/z]		Suggested Starting Parameters		
				min	max	min	max	DOC	Feed	
P Non Alloyed Low Alloyed High Alloyed	1	C35, Ck45, 1020, 1045, 1060, 28Mn6	125 HB	0.50	6.50	0.16	0.58	4.00	0.46	
			190 HB							
			250 HB							
	2	42CrMo4, St50, Ck60, 4140, 4340, 100Cr6	180 HB	0.50	6.50	0.14	0.50	4.00	0.40	
			230 HB				0.44		0.36	
			280 HB							
			350 HB							
	3	X40CrMoV5, H13, M42, D3, S6-5-2, 12Ni19	220 HB	0.50	6.50	0.11	0.44	3.00	0.36	
			280 HB				0.36		0.32	
			320 HB							
			350 HB							
	M Austenitic Duplex Ferritic & Martensitic	4	304, 316, X5CrNi18-9	180 HB	0.50	6.50	0.14	4.00	0.34	
240 HB				0.11						
5		X2CrNiN23-4, S31500	290 HB	0.50	5.00	0.11	0.36	3.00	0.30	
			310 HB							
6		410, X6Cr17, 17-4PH, 430	200 HB	0.50	6.50	0.14	0.44	4.00	0.34	
			42 HRc		5.00		0.40			3.00
K Grey Malleable & Nodular	7	GG20, GG40, EN-GJL-250, N030B	150 HB	0.50	6.50	0.17	0.58	4.00	0.46	
			200 HB							
			250 HB							
	8	GGG40, GGG70, 50005	150 HB	0.50	6.50	0.14	0.52	4.00	0.40	
			200 HB							
			250 HB							
S Fe, Ni & Co based Ti based	9	Incoloy 800	240 HB	0.50	5.00	0.11	0.36	3.00	0.30	
		Inconel 700	250 HB							
		Stellite 21	350 HB							
	10	TiAl6V4 T40	-	0.50	5.00	0.11	0.40	3.00	0.34	
			-				0.36		0.30	
			-							
H Steel Chilled Cast Iron White Cast Iron	11	X100 CrMo13, 440C, G-X260NiCr42	45 HRc	0.40	3.00	0.09	0.36	2.00	0.28	
			50 HRc				0.32	1.50	0.26	
			55 HRc				1.50	0.28	1.00	0.24
			400 HB				3.00	0.36	1.50	0.28
			55 HRc				1.50	0.28	1.00	0.24
			G-X300CrMo15							
NF Aluminium	12	AISI12	130 HB	0.50	6.50	0.17	0.60	4.00	0.50	

The depth of cut and feed rate tables are for the geometry and corner radius specified above the table. Refer to cutting speed tables on page 226 for recommended materials per grade.

MACHINING CONDITIONS - MILLING - DEPTH OF CUT AND FEED

SPKN 1203 EDTR

SPKN 1204 EDTR

Material Group	Lamina Gr. N°	Material Examples	Hardness	DOC [mm]		Feed [mm/z]		Suggested Starting Parameters		
				min	max	min	max	DOC	Feed	
P Non Alloyed Low Alloyed High Alloyed	1	C35, Ck45, 1020, 1045, 1060, 28Mn6	125 HB	0.50	7.00	0.18	0.43	3.00	0.30	
			190 HB							
			250 HB							
	2	42CrMo4, St50, Ck60, 4140, 4340, 100Cr6	180 HB	0.50	7.00	0.15	0.34	3.00	0.26	
			230 HB				0.30		0.23	
			280 HB							
			350 HB							
	3	X40CrMoV5, H13, M42, D3, S6-5-2, 12Ni19	220 HB	0.50	5.00	0.12	0.30	2.30	0.23	
			280 HB				0.24		0.21	
320 HB										
350 HB										
K Grey Malleable & Nodular	7	GG20, GG40, EN-GJL-250, N030B	150 HB	0.50	7.00	0.18	0.43	3.00	0.30	
			200 HB							
			250 HB							
	8	GGG40, GGG70, 50005	150 HB	0.50	7.00	0.15	0.38	3.00	0.26	
			200 HB							
			250 HB							
H Steel Chilled Cast Iron White Cast Iron	11	X100 CrMo13, 440C, G-X260NiCr42	45 HRc	0.50	2.50	0.10	0.24	1.50	0.18	
			50 HRc		1.80		0.22	1.10	0.17	
			55 HRc		1.50		0.19	0.80	0.16	
		Ni-Hard 2	400 HB		2.00		0.24	1.10	0.18	
			G-X300CrMo15		55 HRc		1.50	0.19	0.80	0.16

SPKN 1504 EDTR

Material Group	Lamina Gr. N°	Material Examples	Hardness	DOC [mm]		Feed [mm/z]		Suggested Starting Parameters		
				min	max	min	max	DOC	Feed	
P Non Alloyed Low Alloyed High Alloyed	1	C35, Ck45, 1020, 1045, 1060, 28Mn6	125 HB	0.50	9.00	0.18	0.43	4.00	0.30	
			190 HB							
			250 HB							
	2	42CrMo4, St50, Ck60, 4140, 4340, 100Cr6	180 HB	0.50	9.00	0.15	0.34	4.00	0.26	
			230 HB				0.30		0.23	
			280 HB							
			350 HB							
	3	X40CrMoV5, H13, M42, D3, S6-5-2, 12Ni19	220 HB	0.50	6.40	0.12	0.30	3.00	0.23	
			280 HB				0.24		0.21	
320 HB										
350 HB										
K Grey Malleable & Nodular	7	GG20, GG40, EN-GJL-250, N030B	150 HB	0.50	9.00	0.18	0.43	4.00	0.30	
			200 HB							
			250 HB							
	8	GGG40, GGG70, 50005	150 HB	0.50	9.00	0.15	0.38	4.00	0.26	
			200 HB							
			250 HB							
H Steel Chilled Cast Iron White Cast Iron	11	X100 CrMo13, 440C, G-X260NiCr42	45 HRc	0.50	3.20	0.10	0.24	2.00	0.18	
			50 HRc		2.30		0.22	1.50	0.17	
			55 HRc		1.90		0.19	1.00	0.16	
		Ni-Hard 2	400 HB		2.60		0.24	1.50	0.18	
			G-X300CrMo15		55 HRc		1.90	0.19	1.00	0.16

The depth of cut and feed rate tables are for the geometry and corner radius specified above the table. Refer to cutting speed tables on page 226 for recommended materials per grade.

MACHINING CONDITIONS - MILLING - DEPTH OF CUT AND FEED

SPKR 1203 EDTR
SPKR 1204 EDTR

Material Group	Lamina Gr. N°	Material Examples	Hardness	DOC [mm]		Feed [mm/z]		Suggested Starting Parameters	
				min	max	min	max	DOC	Feed
P Non Alloyed Low Alloyed High Alloyed	1	C35, Ck45, 1020, 1045, 1060, 28Mn6	125 HB	0.50	7.00	0.18	0.38	3.00	0.26
			190 HB						
			250 HB						
	2	42CrMo4, St50, Ck60, 4140, 4340, 100Cr6	180 HB	0.50	7.00	0.15	0.30	3.00	0.23
			230 HB				0.26		0.21
			280 HB						
			350 HB						
	3	X40CrMoV5, H13, M42, D3, S6-5-2, 12Ni19	220 HB	0.50	5.00	0.12	0.26	2.30	0.21
			280 HB						
			320 HB	0.50			0.22		0.18
			350 HB						
	M Austenitic Duplex Ferritic & Martensitic	4	304, 316, X5CrNi18-9	180 HB	0.50	7.00	0.15	0.26	3.00
240 HB				0.12					
5		X2CrNiN23-4, S31500	290 HB	0.50	5.00	0.12	0.22	2.30	0.18
			310 HB						
6		410, X6Cr17, 17-4PH, 430	200 HB	0.50	7.00	0.15	0.26	3.00	0.21
			42 HRc		5.00		0.22		
K Grey Malleable & Nodular	7	GG20, GG40, EN-GJL-250, N030B	150 HB	0.50	7.00	0.18	0.38	3.00	0.26
			200 HB						
			250 HB						
	8	GGG40, GGG70, 50005	150 HB	0.50	7.00	0.15	0.34	3.00	0.23
			200 HB						
			250 HB						
S Fe, Ni & Co based Ti based	9	Incoloy 800	240 HB	0.50	5.00	0.12	0.22	2.30	0.18
		Inconel 700	250 HB						
		Stellite 21	350 HB						
	10	TiAl6V4	-	0.50	5.00	0.12	0.24	2.30	0.21
		T40	-				0.22		0.18
	H Steel Chilled Cast Iron White Cast Iron	11	X100 CrMo13, 440C, G-X260NiCr42	45 HRc	0.50	2.50	0.10	0.22	1.50
50 HRc				1.80		0.19		1.10	0.15
55 HRc				1.50		0.17		0.80	0.14
Ni-Hard 2			400 HB	2.00		0.22		1.10	0.16
			G-X300CrMo15	55 HRc		1.50		0.17	0.80
NF Aluminium				12		AISI12		130 HB	0.50

The depth of cut and feed rate tables are for the geometry and corner radius specified above the table. Refer to cutting speed tables on page 226 for recommended materials per grade.

MACHINING CONDITIONS - MILLING - DEPTH OF CUT AND FEED

SPMT 060304 TN

Material Group	Lamina Gr. N°	Material Examples	Hardness	DOC [mm]		Feed [mm/z]		Suggested Starting Parameters	
				min	max	min	max	DOC	Feed
P Non Alloyed Low Alloyed High Alloyed	1	C35, Ck45, 1020, 1045, 1060, 28Mn6	125 HB	0.30	6.00	0.06	0.12	2.40	0.10
			190 HB				0.10		0.08
			250 HB						
	2	42CrMo4, St50, Ck60, 4140, 4340, 100Cr6	180 HB	0.30	6.00	0.06	0.12	2.40	0.10
			230 HB				0.05		0.10
			280 HB						
			350 HB						
	3	X40CrMoV5, H13, M42, D3, S6-5-2, 12Ni19	220 HB	0.30	6.00	0.06	0.08	1.80	0.07
			280 HB				0.05		0.10
			320 HB						
			350 HB						
	M Austenitic Duplex Ferritic & Martensitic	4	304, 316, X5CrNi18-9	180 HB	0.30	6.00	0.06	0.08	2.40
240 HB				0.05					
5		X2CrNiN23-4, S31500	290 HB	0.30	6.00	0.05	0.08	1.80	0.07
			310 HB				0.07		0.06
6		410, X6Cr17, 17-4PH, 430	200 HB	0.30	6.00	0.05	0.08	2.40	0.07
			42 HRc				0.07		0.06
K Grey Malleable & Nodular	7	GG20, GG40, EN-GJL-250, N030B	150 HB	0.30	6.00	0.05	0.14	2.40	0.12
			200 HB				0.12		0.10
			250 HB						
	8	GGG40, GGG70, 50005	150 HB	0.30	6.00	0.05	0.14	2.40	0.12
			200 HB				0.12		0.10
			250 HB						
S Fe, Ni & Co based Ti based	9	Incoloy 800	0.30	6.00	0.04	0.08	1.80	0.06	
		Inconel 700							250 HB
		Stellite 21							350 HB
	10	TiAl6V4	-	0.30	6.00	0.04	0.08	1.80	0.06
T40		-							
H Steel Chilled Cast Iron White Cast Iron	11	X100 CrMo13, 440C, G-X260NiCr42	45 HRc	0.30	6.00	0.04	0.10	1.20	0.08
			50 HRc				0.08	0.90	0.06
			55 HRc				0.06	0.60	0.05
		Ni-Hard 2	400 HB					0.90	
		G-X300CrMo15	55 HRc				0.60		
NF Aluminium	12	AlSi12	130 HB	0.30	6.00	0.08	0.14	2.40	0.12

The depth of cut and feed rate tables are for the geometry and corner radius specified above the table. Refer to cutting speed tables on page 226 for recommended materials per grade.

MACHINING CONDITIONS - MILLING - DEPTH OF CUT AND FEED

SPMT 09T308 TN

Material Group	Lamina Gr. N°	Material Examples	Hardness	DOC [mm]		Feed [mm/z]		Suggested Starting Parameters	
				min	max	min	max	DOC	Feed
P Non Alloyed Low Alloyed High Alloyed	1	C35, Ck45, 1020, 1045, 1060, 28Mn6	125 HB	0.50	9.00	0.07	0.17	2.40	0.15
			190 HB						0.13
			250 HB						
	2	42CrMo4, St50, Ck60, 4140, 4340, 100Cr6	180 HB	0.50	9.00	0.07	0.17	2.40	0.15
			230 HB						0.13
			280 HB						0.11
			350 HB						
	3	X40CrMoV5, H13, M42, D3, S6-5-2, 12Ni19	220 HB	0.50	9.00	0.07	0.15	1.80	0.13
			280 HB						0.11
			320 HB						0.08
			350 HB						
	M Austenitic Duplex Ferritic & Martensitic	4	304, 316, X5CrNi18-9	180 HB	0.50	9.00	0.07	0.12	2.40
240 HB				0.08					
5		X2CrNiN23-4, S31500	290 HB	0.50	9.00	0.05	0.10	1.80	0.08
			310 HB						0.07
6		410, X6Cr17, 17-4PH, 430	200 HB	0.50	9.00	0.05	0.08	2.40	0.07
			42 HRc						1.80
K Grey Malleable & Nodular	7	GG20, GG40, EN-GJL-250, N030B	150 HB	0.50	9.00	0.06	0.22	2.40	0.18
			200 HB				0.20		0.16
			250 HB						
	8	GGG40, GGG70, 50005	150 HB	0.50	9.00	0.06	0.22	2.40	0.18
			200 HB			0.05	0.20		0.16
			250 HB						
S Fe, Ni & Co based Ti based	9	Incoloy 800	0.50	9.00	0.04	0.12	1.80	0.10	
		Inconel 700							
		Stellite 21							
10	TiAl6V4	-	0.50	9.00	0.04	0.12	1.80	0.10	
	T40	-							
H Steel Chilled Cast Iron White Cast Iron	11	X100 CrMo13, 440C, G-X260NiCr42	45 HRc	0.50	9.00	0.04	0.12	1.20	0.10
			50 HRc				0.10	0.90	0.08
			55 HRc				0.08	0.60	0.06
		400 HB	0.90						
		G-X300CrMo15	55 HRc				0.60		
NF Aluminium	12	AISI12	130 HB	0.50	9.00	0.08	0.16	2.40	0.13

The depth of cut and feed rate tables are for the geometry and corner radius specified above the table. Refer to cutting speed tables on page 226 for recommended materials per grade.

MACHINING CONDITIONS - MILLING - DEPTH OF CUT AND FEED

SPMT 120408 TN

Material Group	Lamina Gr. N°	Material Examples	Hardness	DOC [mm]		Feed [mm/z]		Suggested Starting Parameters		
				min	max	min	max	DOC	Feed	
P Non Alloyed Low Alloyed High Alloyed	1	C35, Ck45, 1020, 1045, 1060, 28Mn6	125 HB	0.50	12.00	0.10	0.22	3.20	0.19	
			190 HB						0.17	
			250 HB							
	2	42CrMo4, St50, Ck60, 4140, 4340, 100Cr6	180 HB	0.50	12.00	0.10	0.22	3.20	0.19	
			230 HB						0.17	
			280 HB							
			350 HB						0.15	
	3	X40CrMoV5, H13, M42, D3, S6-5-2, 12Ni19	220 HB	0.50	12.00	0.08	0.20	2.40	0.17	
			280 HB							
320 HB			0.15							
350 HB			0.14							
M Austenitic Duplex Ferritic & Martensitic	4	304, 316, X5CrNi18-9	180 HB	0.50	12.00	0.09	0.12	3.20	0.10	
			240 HB						0.08	
	5	X2CrNiN23-4, S31500	290 HB	0.50	12.00	0.08	0.10	2.40	0.08	
			310 HB						0.06	
	6	410, X6Cr17, 17-4PH, 430	200 HB	0.50	12.00	0.08	0.12	3.20	0.10	
			42 HRc						0.06	0.10
K Grey Malleable & Nodular	7	GG20, GG40, EN-GJL-250, N030B	150 HB	0.50	12.00	0.10	0.28	3.20	0.26	
			200 HB				0.26		0.24	
			250 HB				0.24		0.22	
	8	GGG40, GGG70, 50005	150 HB	0.50	12.00	0.10	0.26	3.20	0.24	
			200 HB				0.24		0.22	
			250 HB							
S Fe, Ni & Co based Ti based	9	Incoloy 800	240 HB	0.50	12.00	0.06	0.14	2.40	0.12	
		Inconel 700	250 HB						0.11	
		Stellite 21	350 HB							
10	TiAl6V4	-	0.50	12.00	0.06	0.14	2.40	0.12		
	T40	-								
H Steel Chilled Cast Iron White Cast Iron	11	X100 CrMo13, 440C, G-X260NiCr42	45 HRc	0.50	12.00	0.06	0.14	1.60	0.10	
			50 HRc				0.12			1.20
			55 HRc				0.10			0.80
		Ni-Hard 2	400 HB				1.20	0.08		
		G-X300CrMo15	55 HRc				0.80			
NF Aluminium	12	AlSi12	130 HB	0.50	12.00	0.10	0.18	3.20	0.15	

The depth of cut and feed rate tables are for the geometry and corner radius specified above the table. Refer to cutting speed tables on page 226 for recommended materials per grade.

MACHINING CONDITIONS - MILLING - DEPTH OF CUT AND FEED

SPMT 12T308

Material Group	Lamina Gr. N°	Material Examples	Hardness	DOC [mm]		Feed [mm/z]		Suggested Starting Parameters	
				min	max	min	max	DOC	Feed
P Non Alloyed Low Alloyed High Alloyed	1	C35, Ck45, 1020, 1045, 1060, 28Mn6	125 HB	0.50	9.00	0.13	0.29	3.00	0.18
			190 HB						
			250 HB						
	2	42CrMo4, St50, Ck60, 4140, 4340, 100Cr6	180 HB	0.50	9.00	0.10	0.22	3.00	0.16
			230 HB				0.20		0.14
			280 HB						
			350 HB						
	3	X40CrMoV5, H13, M42, D3, S6-5-2, 12Ni19	220 HB	0.50	6.40	0.08	0.20	2.30	0.14
			280 HB				0.16		0.13
			320 HB						
			350 HB						
	M Austenitic Duplex Ferritic & Martensitic	4	304, 316, X5CrNi18-9	180 HB	0.50	9.00	0.10	3.00	0.16
240 HB				0.08			0.20		
5		X2CrNiN23-4, S31500	290 HB	0.50	6.40	0.08	0.16	2.30	0.13
			310 HB						
6		410, X6Cr17, 17-4PH, 430	200 HB	0.50	9.00	0.10	0.22	3.00	0.16
			42 HRc		6.40		0.18		
K Grey Malleable & Nodular	7	GG20, GG40, EN-GJL-250, N030B	150 HB	0.50	9.00	0.13	0.29	3.00	0.18
			200 HB						
			250 HB						
	8	GGG40, GGG70, 50005	150 HB	0.50	9.00	0.10	0.25	3.00	0.16
			200 HB						
			250 HB						
S Fe, Ni & Co based Ti based	9	Incoloy 800	240 HB	0.50	6.40	0.08	0.16	2.30	0.13
		Inconel 700	250 HB						
		Stellite 21	350 HB						
	10	TiAl6V4	-	0.50	6.40	0.08	0.18	2.30	0.14
		T40	-				0.16		0.13
	H Steel Chilled Cast Iron White Cast Iron	11	X100 CrMo13, 440C, G-X260NiCr42	45 HRc	0.50	3.20	0.07	0.16	1.50
50 HRc				1.90		0.14		1.10	0.10
55 HRc				1.00		0.13		0.80	0.10
Ni-Hard 2			400 HB	2.60		0.16		1.10	0.11
			G-X300CrMo15	55 HRc		1.00		0.13	0.80
NF Aluminium				12		AISI12		130 HB	0.50

The depth of cut and feed rate tables are for the geometry and corner radius specified above the table. Refer to cutting speed tables on page 226 for recommended materials per grade.

MACHINING CONDITIONS - MILLING - DEPTH OF CUT AND FEED

SPUN 120308

Material Group	Lamina Gr. N°	Material Examples	Hardness	DOC [mm]		Feed [mm/z]		Suggested Starting Parameters			
				min	max	min	max	DOC	Feed		
P K H	1	C35, Ck45, 1020, 1045, 1060, 28Mn6	125 HB	0.50	7.00	0.18	0.37	3.00	0.26		
			190 HB								
			250 HB								
	2	42CrMo4, St50, Ck60, 4140, 4340, 100Cr6	180 HB	0.50	7.00	0.15	0.29	3.00	0.23		
			230 HB				0.25		0.21		
			280 HB								
			350 HB								
	3	X40CrMoV5, H13, M42, D3, S6-5-2, 12Ni19	220 HB	0.50	5.00	0.12	0.25	2.30	0.21		
			280 HB				0.21		0.18		
			320 HB								
			350 HB								
	7	GG20, GG40, EN-GJL-250, N030B	150 HB	0.50	7.00	0.18	0.37	3.00	0.26		
200 HB											
250 HB											
8	GGG40, GGG70, 50005	150 HB	0.50	7.00	0.15	0.32	3.00	0.23			
		200 HB									
		250 HB									
11	X100 CrMo13, 440C, G-X260NiCr42	45 HRc	0.50	2.50	0.10	0.21	1.50	0.16			
		50 HRc				1.80		1.10			
		55 HRc				1.50		0.80			
		400 HB				2.00		0.21	1.10	0.16	
						55 HRc		1.50	0.16	0.80	0.14
Chilled Cast Iron	Ni-Hard 2	400 HB	0.50	2.00	0.10	0.21	1.10	0.16			
									White Cast Iron	G-X300CrMo15	55 HRc

The depth of cut and feed rate tables are for the geometry and corner radius specified above the table. Refer to cutting speed tables on page 226 for recommended materials per grade.

MACHINING CONDITIONS - MILLING - DEPTH OF CUT AND FEED

TPKN 1603 PDTR

Material Group	Lamina Gr. N°	Material Examples	Hardness	DOC [mm]		Feed [mm/z]		Suggested Starting Parameters		
				min	max	min	max	DOC	Feed	
P Non Alloyed Low Alloyed High Alloyed	1	C35, Ck45, 1020, 1045, 1060, 28Mn6	125 HB	0.50	12.00	0.14	0.27	3.00	0.19	
			190 HB							
			250 HB							
	2	42CrMo4, St50, Ck60, 4140, 4340, 100Cr6	180 HB	0.50	12.00	0.12	0.21	3.00	0.17	
			230 HB				0.19		0.15	
			280 HB							
			350 HB							
	3	X40CrMoV5, H13, M42, D3, S6-5-2, 12Ni19	220 HB	0.50	8.60	0.10	0.19	2.30	0.15	
			280 HB				0.15		0.14	
320 HB										
350 HB										
K Grey Malleable & Nodular	7	GG20, GG40, EN-GJL-250, N030B	150 HB	0.50	12.00	0.14	0.27	3.00	0.19	
			200 HB							
			250 HB							
	8	GGG40, GGG70, 50005	150 HB	0.50	12.00	0.12	0.24	3.00	0.17	
			200 HB							
			250 HB							
H Steel Chilled Cast Iron White Cast Iron	11	X100 CrMo13, 440C, G-X260NiCr42	45 HRc	0.50	4.30	0.08	0.15	1.50	0.12	
			50 HRc		3.00		0.14	1.10	0.11	
			55 HRc		2.60		0.12	0.80	0.10	
		Ni-Hard 2	400 HB		3.40		0.15	1.10	0.12	
			G-X300CrMo15		55 HRc		2.60	0.12	0.80	0.10

TPKN 2204 PDTR

Material Group	Lamina Gr. N°	Material Examples	Hardness	DOC [mm]		Feed [mm/z]		Suggested Starting Parameters		
				min	max	min	max	DOC	Feed	
P Non Alloyed Low Alloyed High Alloyed	1	C35, Ck45, 1020, 1045, 1060, 28Mn6	125 HB	0.50	18.00	0.16	0.27	4.00	0.19	
			190 HB							
			250 HB							
	2	42CrMo4, St50, Ck60, 4140, 4340, 100Cr6	180 HB	0.50	18.00	0.14	0.21	4.00	0.17	
			230 HB				0.19		0.15	
			280 HB							
			350 HB							
	3	X40CrMoV5, H13, M42, D3, S6-5-2, 12Ni19	220 HB	0.50	12.90	0.11	0.19	3.00	0.15	
			280 HB				0.15		0.13	
320 HB										
350 HB										
K Grey Malleable & Nodular	7	GG20, GG40, EN-GJL-250, N030B	150 HB	0.50	18.00	0.16	0.27	4.00	0.19	
			200 HB							
			250 HB							
	8	GGG40, GGG70, 50005	150 HB	0.50	18.00	0.14	0.24	4.00	0.17	
			200 HB							
			250 HB							
H Steel Chilled Cast Iron White Cast Iron	11	X100 CrMo13, 440C, G-X260NiCr42	45 HRc	0.50	6.40	0.09	0.15	2.00	0.12	
			50 HRc		4.50		0.14	1.50	0.11	
			55 HRc		3.90		0.12	1.00	0.10	
		Ni-Hard 2	400 HB		5.10		0.15	1.50	0.12	
			G-X300CrMo15		55 HRc		3.90	0.12	1.00	0.10

The depth of cut and feed rate tables are for the geometry and corner radius specified above the table. Refer to cutting speed tables on page 226 for recommended materials per grade.

MACHINING CONDITIONS - MILLING - DEPTH OF CUT AND FEED

TPKR 1603 PDTR

Material Group	Lamina Gr. N°	Material Examples	Hardness	DOC [mm]		Feed [mm/z]		Suggested Starting Parameters	
				min	max	min	max	DOC	Feed
P Non Alloyed Low Alloyed High Alloyed	1	C35, Ck45, 1020, 1045, 1060, 28Mn6	125 HB	0.50	12.00	0.13	0.22	3.00	0.17
			190 HB						
			250 HB						
	2	42CrMo4, St50, Ck60, 4140, 4340, 100Cr6	180 HB	0.50	12.00	0.10	0.17	3.00	0.15
			230 HB						
			280 HB				0.15		
			350 HB						
	3	X40CrMoV5, H13, M42, D3, S6-5-2, 12Ni19	220 HB	0.50	8.60	0.08	0.15	2.30	0.13
			280 HB						
			320 HB				0.13		
			350 HB						
	M Austenitic Duplex Ferritic & Martensitic	4	304, 316, X5CrNi18-9	180 HB	0.50	12.00	0.10	0.15	3.00
240 HB									
5		X2CrNiN23-4, S31500	290 HB	0.50	8.60	0.08	0.13	2.30	0.12
			310 HB						
6		410, X6Cr17, 17-4PH, 430	200 HB	0.50	12.00	0.10	0.15	3.00	0.13
			42 HRc		8.60				
K Grey Malleable & Nodular	7	GG20, GG40, EN-GJL-250, N030B	150 HB	0.50	12.00	0.13	0.22	3.00	0.17
			200 HB						
			250 HB						
	8	GGG40, GGG70, 50005	150 HB	0.50	12.00	0.10	0.20	3.00	0.15
			200 HB						
			250 HB						
S Fe, Ni & Co based Ti based	9	Incoloy 800	0.50	8.60	0.08	0.13	2.30	0.12	
		Inconel 700							
		Stellite 21							
	10	TiAl6V4	0.50	8.60	0.08	0.14	2.30	0.13	
		T40							0.13
	H Steel Chilled Cast Iron White Cast Iron	11	X100 CrMo13, 440C, G-X260NiCr42	45 HRc	0.50	4.30	0.07	0.13	1.50
50 HRc				3.00		0.11		1.10	0.09
55 HRc				2.60		0.10		0.80	0.09
Ni-Hard 2			400 HB	3.40		0.13		1.10	0.10
			G-X300CrMo15	55 HRc		2.60		0.10	0.80
NF Aluminium				12		AlSi12		130 HB	0.50

The depth of cut and feed rate tables are for the geometry and corner radius specified above the table. Refer to cutting speed tables on page 226 for recommended materials per grade.

MACHINING CONDITIONS - MILLING - DEPTH OF CUT AND FEED

TPKR 2204 PDTR

Material Group	Lamina Gr. N°	Material Examples	Hardness	DOC [mm]		Feed [mm/z]		Suggested Starting Parameters	
				min	max	min	max	DOC	Feed
P Non Alloyed Low Alloyed High Alloyed	1	C35, Ck45, 1020, 1045, 1060, 28Mn6	125 HB	0.50	18.00	0.13	0.22	4.00	0.17
			190 HB						
			250 HB						
	2	42CrMo4, St50, Ck60, 4140, 4340, 100Cr6	180 HB	0.50	18.00	0.10	0.17	4.00	0.15
			230 HB				0.15		0.13
			280 HB						
			350 HB						
	3	X40CrMoV5, H13, M42, D3, S6-5-2, 12Ni19	220 HB	0.50	12.90	0.08	0.15	3.00	0.13
			280 HB				0.13		0.12
			320 HB						
			350 HB						
	M Austenitic Duplex Ferritic & Martensitic	4	304, 316, X5CrNi18-9	180 HB	0.50	18.00	0.10	4.00	0.13
240 HB				0.08					
5		X2CrNiN23-4, S31500	290 HB	0.50	12.90	0.08	0.13	3.00	0.12
			310 HB						
6		410, X6Cr17, 17-4PH, 430	200 HB	0.50	18.00	0.10	0.15	4.00	0.13
			42 HRc		12.90		0.13		
K Grey Malleable & Nodular	7	GG20, GG40, EN-GJL-250, N030B	150 HB	0.50	18.00	0.13	0.22	4.00	0.17
			200 HB						
			250 HB						
	8	GGG40, GGG70, 50005	150 HB	0.50	18.00	0.10	0.20	4.00	0.15
			200 HB						
			250 HB						
S Fe, Ni & Co based Ti based	9	Incoloy 800	240 HB	0.50	12.90	0.08	0.13	3.00	0.12
		Inconel 700	250 HB						
		Stellite 21	350 HB						
	10	TiAl6V4 T40	-	0.50	12.90	0.08	0.14	3.00	0.13
			-				0.13		0.12
			-						
H Steel Chilled Cast Iron White Cast Iron	11	X100 CrMo13, 440C, G-X260NiCr42	45 HRc	0.50	6.40	0.07	0.13	2.00	0.10
			50 HRc		4.50		0.11	1.50	0.09
			55 HRc		3.90		0.10	1.00	0.09
		Ni-Hard 2 G-X300CrMo15	400 HB		5.10		0.13	1.50	0.10
			55 HRc		3.90		0.10	1.00	0.09
NF Aluminium	12	AISI12	130 HB	0.50	18.00	0.13	0.22	4.00	0.18

The depth of cut and feed rate tables are for the geometry and corner radius specified above the table. Refer to cutting speed tables on page 226 for recommended materials per grade.

MACHINING CONDITIONS - MILLING - DEPTH OF CUT AND FEED

TPUN 160308

Material Group	Lamina Gr. N°	Material Examples	Hardness	DOC [mm]		Feed [mm/z]		Suggested Starting Parameters											
				min	max	min	max	DOC	Feed										
P K H	1	C35, Ck45, 1020, 1045, 1060, 28Mn6	125 HB	0.50	12.00	0.14	0.27	3.00	0.19										
			190 HB																
			250 HB																
	2	42CrMo4, St50, Ck60, 4140, 4340, 100Cr6	180 HB	0.50	12.00	0.12	0.21	3.00	0.17										
			230 HB				0.19		0.15										
			280 HB																
			350 HB																
	3	X40CrMoV5, H13, M42, D3, S6-5-2, 12Ni19	220 HB	0.50	8.60	0.10	0.19	2.30	0.15										
			280 HB				0.15		0.14										
			320 HB																
			350 HB																
	7	GG20, GG40, EN-GJL-250, N030B	150 HB	0.50	12.00	0.14	0.27	3.00	0.19										
200 HB																			
250 HB																			
8	GGG40, GGG70, 50005	150 HB	0.50	12.00	0.12	0.24	3.00	0.17											
		200 HB																	
		250 HB																	
11	X100 CrMo13, 440C, G-X260NiCr42	45 HRc	0.50	4.30	0.08	0.15	1.50	0.12											
		50 HRc							3.00	0.14	1.10	0.11							
		55 HRc							2.60										
		400 HB							3.40				0.15	1.10	0.12				
									55 HRc							2.60	0.12	0.80	0.10
White Cast Iron	G-X300CrMo15	55 HRc		2.60		0.12	0.80	0.10											

The depth of cut and feed rate tables are for the geometry and corner radius specified above the table. Refer to cutting speed tables on page 226 for recommended materials per grade.

MACHINING CONDITIONS

ALU
TURNING

ALU
MILLING

MACHINING CONDITIONS - ALU TURNING & MILLING - CUTTING SPEED (Vc)

LT 05 — NON FERROUS

Material Group	Lamina Gr. N°	Material Examples	Hardness	LT 05 ALU- Turning Vc [m/min]			LT 05 ALU - Milling Vc [m/min]		
				min	max	sugg. start speed	min	max	sugg. start speed
NF	13	4% < Si < 8%	100 HB	250	600	300	250	600	400
		Si < 4%	60 HB	400	1200	400	400	1200	500
	14	CuZn30	100HB	150	800	250	100	800	300
	15	Fiber Plastics	-	70	500	150	80	500	200
		Graphite	-	100	200	150	100	200	150
Hard Rubber	-	80	300	150	80	300	150		

MACHINING CONDITIONS - ALU TURNING - DEPTH OF CUT AND FEED

CCGT 060204 ALU

Material Group	Lamina Gr. N°	Material Examples	Hardness	DOC [mm]		Feed [mm/rev]		Amax [mm ²]	Suggested Starting Parameters	
				min	max	min	max		DOC	Feed
AL (<8%Si)	13	4% < Si < 8%	100 HB	0.30	2.50	0.10	0.29	1.02	1.50	0.23
		Si < 4%	60 HB			0.12	0.33	1.28		
	Copper Alloys	14	CuZn30	100HB	0.30	2.50	0.10	0.29	1.02	1.50
Non Metallic	15	Fiber Plastics	-	0.30	2.50	0.10	0.19	1.02	1.20	0.15
		Graphite	-							
		Hard Rubber	-							

CCGT 09T304 ALU CNGG 09T304 ALU CNGG 120404 ALU

DCGT 11T304 ALU DNGG 110404 ALU TNGG 160404 ALU

VNGG 160404 ALU WNGG 060404 ALU WNGG 080404 ALU

Material Group	Lamina Gr. N°	Material Examples	Hardness	DOC [mm]		Feed [mm/rev]		Amax [mm ²]	Suggested Starting Parameters	
				min	max	min	max		DOC	Feed
AL (<8%Si)	13	4% < Si < 8%	100 HB	0.30	4.50	0.10	0.30	1.20	2.30	0.23
		Si < 4%	60 HB			0.12	0.35	1.50		
Copper Alloys	14	CuZn30	100HB	0.30	4.50	0.10	0.30	1.20	2.30	0.23
Non Metallic	15	Fiber Plastics	-	0.30	4.50	0.10	0.20	1.20	1.80	0.15
		Graphite	-							
		Hard Rubber	-							

CNGG 120408 ALU DNGG 110408 ALU

DNGG 150608 ALU VNGG 160408 ALU

Material Group	Lamina Gr. N°	Material Examples	Hardness	DOC [mm]		Feed [mm/rev]		Amax [mm ²]	Suggested Starting Parameters	
				min	max	min	max		DOC	Feed
AL (<8%Si)	13	4% < Si < 8%	100 HB	0.50	6.00	0.18	0.50	1.20	3.00	0.32
		Si < 4%	60 HB				0.60	1.50		
Copper Alloys	14	CuZn30	100HB	0.50	6.00	0.15	0.40	1.20	3.00	0.25
Non Metallic	15	Fiber Plastics	-	0.50	6.00	0.15	0.40	1.20	3.00	0.25
		Graphite	-							
		Hard Rubber	-							

MACHINING CONDITIONS - ALU MILLING - DEPTH OF CUT AND FEED

APGT 100304 PDER ALU

Material Group	Lamina Gr. N°	Material Examples	Hardness	DOC [mm]		Feed [mm/rev]		Suggested Starting Parameters	
				min	max	min	max	DOC	Feed
AL (<8%Si)	13	4% < Si < 8%	100 HB	0.30	9.00	0.10	0.18	3.00	0.14
		Si < 4%	60 HB			0.12	0.20		
Copper Alloys	14	CuZn30	100HB	0.30	9.00	0.10	0.18	3.00	0.14
Non Metallic	15	Fiber Plastics	-	0.30	9.00	0.12	0.20	3.00	0.12
		Graphite	-						
		Hard Rubber	-						

APGT 160408 PDER ALU

Material Group	Lamina Gr. N°	Material Examples	Hardness	DOC [mm]		Feed [mm/rev]		Suggested Starting Parameters	
				min	max	min	max	DOC	Feed
AL (<8%Si)	13	4% < Si < 8%	100 HB	0.50	15.00	0.13	0.29	4.00	0.16
		Si < 4%	60 HB			0.15	0.32		
Copper Alloys	14	CuZn30	100HB	0.50	15.00	0.13	0.29	4.00	0.16
Non Metallic	15	Fiber Plastics	-	0.50	15.00	0.15	0.32	4.00	0.16
		Graphite	-						
		Hard Rubber	-						

SEGT 1204 AFEN ALU

Material Group	Gr. N°	Material Examples	Hardness	DOC [mm]		Feed [mm/rev]		Suggested Starting Parameters	
				min	max	min	max	DOC	Feed
AL (<8%Si)	13	4% < Si < 8%	100 HB	0.30	9.00	0.10	0.35	3.00	0.25
		Si < 4%	60 HB			0.12			
Copper Alloys	14	CuZn30	100HB	0.30	9.00	0.10	0.35	3.00	0.25
Non Metallic	15	Fiber Plastics	-	0.30	9.00	0.12	0.35	3.00	0.20
		Graphite	-						
		Hard Rubber	-						

MACHINING CONDITIONS

PARTING AND GROOVING

MACHINING CONDITIONS - PARTING & GROOVING - CUTTING SPEED (Vc)

LT 10
LT 1000

Material Group	Lamina Gr. N°	Material Examples	Hardness	LT10 Vc [m/min]		LT 1000 Vc [m/min]	
				min	max	min	max
P Non Alloyed Low Alloyed High Alloyed	1	C35, Ck45, 1020, 1045, 1060, 28Mn6	125 HB	110	220	130	220
			190 HB		180		220
			250 HB		170		200
	2	42CrMo4, Sf50, Ck60, 4140, 4340, 100Cr6	180 HB	70	180	90	200
			230 HB		170		170
			280 HB		140		170
			350 HB		120		150
	3	X40CrMoV5, H13, M42, D3, S6-5-2, 12Ni19	220 HB	40	130	60	170
			280 HB		100		150
320 HB			90		130		
4	304, 316, X5CrNi18-9	180 HB	100	180	90	150	
		240 HB		150		140	
		5		X2CrNiN23-4, S31500		290 HB	50
310 HB	40		90				
6	410, X6Cr17, 17-4PH, 430	200 HB	100	170	60	130	
		42 HRc	70	130			50
K Grey Malleable & Nodular	7	GG20, GG40, EN-GJL-250, N030B	150 HB	100	170	130	190
			200 HB		150		
			250 HB		90		
8	GGG40, GGG70, 50005	150 HB	70	170	90	150	
		200 HB		150			
		250 HB		130			
S Fe, Ni & Co based Ti based	9	Incoloy 800	20	240 HB	30	40	
		Inconel 700		250 HB			40
		Stellite 21		350 HB			30
10	T40 TiAl6V4	-	30	-	40	60	
		-		20			40
H Steel Chilled Cast Iron White Cast Iron	11	X100 CrMo13, 440C, G-X260NiCr42	45 HRc	30	70	50	90
			50 HRc		60		70
			55 HRc		50		30
		Ni-Hard 2	400 HB		40	40	
		G-X300CrMo15	55 HRc		20	30	50
NF Aluminium	12	AlSi12	130 HB	120	260	100	300

MACHINING CONDITIONS - PARTING & GROOVING - DEPTH OF CUT AND FEED

GCTX 2002 NN
GCTX 3003 NN
GCTX 3003 PP

Material Group	Lamina Gr. N°	Material Examples	Hardness	GCTX 2002 NN Feed [mm/rev]		GCTX 3003 NN Feed [mm/rev]		GCTX 3003 PP Feed [mm/rev]	
				min	max	min	max	min	max
Non Alloyed P Low Alloyed High Alloyed	1	C35, Ck45, 1020, 1045, 1060, 28Mn6	125 HB	0.50	0.17	0.05	0.17	0.05	0.17
			190 HB						
			250 HB						
	2	42CrMo4, S150, Ck60, 4140, 4340, 100Cr6	180 HB	0.50	0.15	0.05	0.15	0.05	0.15
			230 HB						
			280 HB						
			350 HB						
	3	X40CrMoV5, H13, M42, D3, S6-5-2, 12Ni19	220 HB	0.50	0.14	0.05	0.14	0.05	0.14
			280 HB						
320 HB									
4	304, 316, X5CrNi18-9	180 HB	0.50	0.10	0.05	0.10	0.05	0.10	
		240 HB							
		290 HB							
M Duplex Ferritic & Martensitic	5	X2CrNiN23-4, S31500	310 HB	0.50	0.09	0.05	0.09	0.05	0.09
			200 HB						
	6	410, X6Cr17, 17-4PH, 430	42 HRc	0.50	0.09	0.05	0.09	0.05	0.09
K Grey Malleable & Nodular	7	GG20, GG40, EN-GJL-250, N030B	150 HB	0.50	0.16	0.05	0.16	0.05	0.16
			200 HB						
			250 HB						
S Fe, Ni & Co based Ti based	9	Incoloy 800 Inconel 700 Stellite 21	150 HB	0.50	0.08	0.05	0.08	0.05	0.08
			240 HB						
			250 HB						
H Steel Chilled Cast Iron White Cast Iron	11	X100 CrMo13, 440C, G-X260NiCr42	-	0.50	0.08	0.05	0.08	0.05	0.08
			TiAl6V4						
			-						
NF Aluminium	12	AlSi12	45 HRc	0.50	0.10	0.05	0.11	0.05	0.11
			50 HRc						
			55 HRc						
NF Aluminium	12	AlSi12	400 HB	0.50	0.10	0.05	0.11	0.05	0.11
			55 HRc						
			130 HB						

MACHINING CONDITIONS - PARTING & GROOVING - DEPTH OF CUT AND FEED

MGMN 200 G
MGMN 300 M

MGMN 400 M
MGMN 500 M

Material Group	Lamina Gr. N°	Material Examples	Hardness	MGMN 200 G Feed [mm/rev]		MGMN 300 M Feed [mm/rev]		MGMN 400 M Feed [mm/rev]		MGMN 500 M Feed [mm/rev]					
				min	max	min	max	min	max	min	max				
P Non Alloyed Low Alloyed High Alloyed	1	C35, Ck45, 1020, 1045, 1060, 28Mn6	125 HB	0.06	0.21	0.07	0.25	0.13	0.35	0.20	0.41				
			190 HB									0.20	0.24	0.33	0.40
			250 HB									0.18	0.22	0.30	0.36
	2	42CrMo4, S150, Ck60, 4140, 4340, 100Cr6	180 HB	0.05	0.18	0.06	0.22	0.12	0.30	0.18	0.36				
			230 HB									0.16	0.20	0.27	0.32
			280 HB												
			350 HB												
	3	X40CrMoV5, H13, M42, D3, S6-5-2, 12Ni19	220 HB	0.05	0.16	0.05	0.20	0.11	0.27	0.16	0.32				
			280 HB									0.14	0.18	0.24	0.29
320 HB															
350 HB															
4	304, 316, X5CrNi18-9	180 HB	0.05	0.16	0.06	0.20	0.12	0.27	0.18	0.32					
		240 HB													
5	X2CrNiN23-4, S31500	290 HB	0.05	0.13	0.05	0.15	0.11	0.21	0.16	0.25					
		310 HB													
6	410, X6Cr17, 17-4PH, 430	200 HB	0.05	0.16	0.06	0.20	0.12	0.27	0.18	0.32					
		42 HRC									0.14	0.18	0.24	0.29	
7	GG20, GG40, EN-GJL-250, N030B	150 HB	0.04	0.18	0.05	0.22	0.10	0.30	0.14	0.36					
		200 HB													
		250 HB													
8	GG40, GGG70, 50005	150 HB	0.04	0.16	0.05	0.20	0.10	0.27	0.14	0.32					
		200 HB													
		250 HB													
9	Incoloy 800	240 HB	0.05	0.14	0.05	0.17	0.11	0.23	0.16	0.27					
		Inconel 700									250 HB	0.27			
		Stellite 21									350 HB				
10	T40	-	0.05	0.14	0.05	0.18	0.11	0.24	0.16	0.29					
		TiAl6V4									-	0.13	0.15	0.21	0.25
11	X100 CrMo13, 440C, G-X260NiCr42	45 HRC	0.03	0.08	0.03	0.13	0.06	0.18	0.09	0.22					
		50 HRC									0.09	0.11	0.15	0.18	
		55 HRC									0.08	0.10	0.14	0.16	
		400 HB									0.11	0.13	0.18	0.22	
		55 HRC									0.08	0.10	0.14	0.16	
12	AlSi12	130 HB	0.05	0.27	0.06	0.33	0.12	0.45	0.18	0.54					

When using grooving inserts for side turning, the cutting depth is dependent upon the width of insert, the material and the rigidity of the workpiece.

Depth of cut recommendation:

- Max Ap (d.o.c.) is equal to 70% of insert width
- Min Ap (d.o.c.) is equal to the corner radius

MACHINING CONDITIONS - PARTING & GROOVING - DEPTH OF CUT AND FEED

WGE 2000
WGE 3000

WGE 4000
WGE 5000

Material Group	Lamina Gr. N°	Material Examples	Hardness	WGE 2000 Feed [mm/rev]		WGE 3000 Feed [mm/rev]		WGE 4000 Feed [mm/rev]		WGE 5000 Feed [mm/rev]									
				min	max	min	max	min	max	min	max								
P Non Alloyed Low Alloyed High Alloyed	1	C35, Ck45, 1020, 1045, 1060, 28Mn6	125 HB	0.04	0.12	0.07	0.24	0.08	0.26	0.08	0.30								
			190 HB									0.11	0.23	0.25	0.29				
			250 HB													0.10	0.21	0.23	0.26
	2	42CrMo4, St50, Ck60, 4140, 4340, 100Cr6	180 HB	0.04	0.10	0.06	0.21	0.07	0.23	0.07	0.26								
			230 HB									0.09	0.19	0.21	0.23				
			280 HB													0.07	0.18	0.21	0.23
			350 HB																
	3	X40CrMoV5, H13, M42, D3, S6-5-2, 12Ni19	220 HB	0.04	0.08	0.05	0.19	0.06	0.21	0.06	0.23								
			280 HB									0.07	0.17	0.18	0.21				
			320 HB													0.15	0.16	0.18	
4	304, 316, X5CrNi18-9	180 HB	0.04	0.09	0.06	0.19	0.07	0.21	0.07	0.23									
		240 HB																	
M Duplex Ferritic & Martensitic	5	X2CrNiN23-4, S31500	290 HB	0.04	0.07	0.05	0.15	0.06	0.16	0.06	0.18								
			310 HB																
	6	410, X6Cr17, 17-4PH, 430	200 HB	0.04	0.09	0.06	0.19	0.07	0.21	0.07	0.23								
			42 HRc									0.08	0.17	0.18	0.21				
K Grey Malleable & Nodular	7	GG20, GG40, EN-GJL-250, N030B	150 HB	0.03	0.10	0.05	0.21	0.06	0.23	0.06	0.26								
			200 HB																
			250 HB																
S Fe, Ni & Co based Ti based	9	Incoloy 800	0.04	0.08	0.05	0.16	0.06	0.17	0.06	0.20									
		Inconel 700																	
		Stellite 21																	
10	T40	0.04	0.08	0.05	0.17	0.06	0.18	0.06	0.21										
	TiAl6V4									0.07	0.15	0.16	0.18						
H Steel Chilled Cast Iron White Cast Iron	11	X100 CrMo13, 440C, G-X260NiCr42	45 HRc	0.03	0.05	0.03	0.13	0.04	0.14					0.04	0.16				
			50 HRc							0.11	0.12	0.13							
			55 HRc										0.09			0.10	0.12		
		Ni-Hard 2	0.06							0.13	0.14	0.16							
		G-X300CrMo15											0.05			0.09	0.10	0.12	
NF Aluminium	12	AlSi12	130 HB	0.04	0.15	0.06	0.32	0.07	0.35	0.07	0.39								

When using grooving inserts for side turning, the cutting depth is dependent upon the width of insert, the material and the rigidity of the workpiece.

Depth of cut recommendation:

- Max Ap (d.o.c.) is equal to 70% of insert width
- Min Ap (d.o.c.) is equal to the corner radius

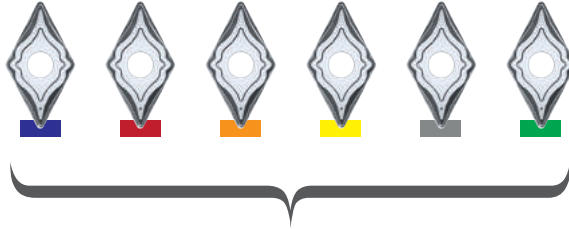

MULTI-MAT™

SIMPLICITY



MACHINING CONDITIONS

SOLID CARBIDE
END MILLS

MACHINING CONDITIONS - SOLID END MILLS - CUTTING SPEED (Vc)

LT 40

LT 4000

Material Group	Lamina Gr. N°	Material Examples	Hardness	LT 40 Vc [m/min]		LT 4000 Vc [m/min]	
				min	max	min	max
P	1	C35, Ck45, 1020, 1045, 1060, 28Mn6	125 HB	70	120	150	200
			190 HB	65	110	140	190
			250 HB	60	100	120	160
	2	42CrMo4, St50, Ck60, 4140, 4340, 100Cr6	180 HB	65	110	120	180
			230 HB	60	90	90	130
			280 HB	55	85	80	120
			350 HB	55	80	60	90
	3	X40CrMoV5, H13, M42, D3, S6-5-2, 12Ni19	220 HB	60	90	70	130
			280 HB	55	80	70	110
320 HB			55	75	60	90	
350 HB			50	70	50	80	
M	4	304, 316, X5CrNi18-9	180 HB	60	80	80	120
			240 HB	50	70	70	120
	5	X2CrNiN23-4, S31500	290 HB	-	-	60	100
			310 HB	-	-	60	90
	6	410, X6Cr17, 17-4PH, 430	200 HB	40	60	50	90
			42 HRc	30	45	30	60
K	7	GG20, GG40, EN- GJL-250, N030B	150 HB	70	120	140	200
			200 HB	65	110	150	190
			250 HB	55	100	120	160
	8	GGG40, GGG70, 50005	150 HB	65	110	130	180
			200 HB	60	100	110	150
			250 HB	55	90	90	130
S	9	Incoloy 800 Inconel 700 Stellite 21	240 HB	-	-	30	50
			250 HB	-	-	30	50
			350 HB	-	-	20	50
	10	T40 TiAl6V4	-	-	-	30	60
			-	-	-	40	70
	H	11	X100CrMo13, 440C, G-X260NiCr42 Ni-Hard 2 G-X300CrMo15	45 HRc	35	60	40
50 HRc				30	50	40	60
55 HRc				-	-	30	50
400 HB				-	-	40	60
55 HRc				-	-	30	50
NF	12	AlSi12	130 HB	120	180	160	250

The depth of cut and feed rate tables on the following pages are for the type and diameter specified above each table. Refer to cutting speeds on this page for recommended materials per grade.

MACHINING CONDITIONS - SOLID END MILLS - DEPTH OF CUT AND FEED

90° 2 FLUTE | LT 40 - Ø 1 - 5

Material Group	Lamina Gr. N°	Material Examples	Hardness	Profiling		Slotting		fz [mm/tooth]				
				ap	ae	ap	Ø1.0	Ø2.0	Ø3.0	Ø4.0	Ø5.0	
P	Non-Alloyed	C35, Ck45, 1020, 1045, 1060, 28Mn6	125 HB	1.5xØ	0.5xØ	1.0xØ	0.008	0.010	0.014	0.019	0.024	
			190 HB									
			250 HB									
	Low Alloyed	42CrMo4, S50, Ck60, 4140, 4340, 100Cr6	180 HB	1.5xØ	0.5xØ	1.0xØ	0.008	0.009	0.013	0.020	0.024	
			230 HB									
			280 HB									
			350 HB									
	High Alloyed	X40CrMoV5, H13, M42, D3, S6-5-2, 12Ni19	220 HB	1.5xØ	0.5xØ	1.0xØ	0.007	0.008	0.012	0.017	0.021	
			280 HB									
320 HB												
350 HB												
M	Austenitic	304, 316, X5CrNi18-9	180 HB	1.5xØ	0.5xØ	1.0xØ	0.006	0.007	0.010	0.014	0.017	
			240 HB									
M	Ferritic & Martensitic	410, X6Cr17, 17-4 PH, 430	200 HB	1.5xØ	0.5xØ	1.0xØ	0.004	0.005	0.007	0.011	0.013	
			42 HRc									
K	Grey	GG20, GG40, EN-GJL-250, No30B	150 HB	1.5xØ	0.5xØ	1.0xØ	0.010	0.011	0.016	0.023	0.029	
			200 HB									
	Malleable & Nodular	GGG40, GGG70, 50005	150 HB	1.5xØ	0.5xØ	1.0xØ	0.008	0.010	0.014	0.020	0.025	
			200 HB									
H	Steel	X100CrMo13, 440C, G-X260NiCr42	45 HRc	1.5xØ	0.3xØ	0.2xØ	0.003	0.004	0.005	0.009	0.011	
			50 HRc									
NF	Al (>8%Si)	AlSi12	130 HB	1.5xØ	0.5xØ	0.1xØ	0.009	0.010	0.015	0.021	0.026	

90° 2 FLUTE | LT 40 - Ø 6, 8, 10, 12, 16

Material Group	Lamina Gr. N°	Material Examples	Hardness	Profiling		Slotting		fz [mm/tooth]				
				ap	ae	ap	Ø6.0	Ø8.0	Ø10.0	Ø12.0	Ø16.0	
P	Non-Alloyed	C35, Ck45, 1020, 1045, 1060, 28Mn6	125 HB	1.5xØ	0.5xØ	1.0xØ	0.032	0.044	0.052	0.062	0.074	
			190 HB									
			250 HB									
	Low Alloyed	42CrMo4, S50, Ck60, 4140, 4340, 100Cr6	180 HB	1.5xØ	0.5xØ	1.0xØ	0.031	0.042	0.050	0.059	0.071	
			230 HB									
			280 HB									
			350 HB									
	High Alloyed	X40CrMoV5, H13, M42, D3, S6-5-2, 12Ni19	220 HB	1.5xØ	0.5xØ	1.0xØ	0.027	0.037	0.044	0.051	0.061	
			280 HB									
320 HB												
350 HB												
M	Austenitic	304, 316, X5CrNi18-9	180 HB	1.5xØ	0.5xØ	1.0xØ	0.022	0.030	0.036	0.042	0.050	
			240 HB									
M	Ferritic & Martensitic	410, X6Cr17, 17-4 PH, 430	200 HB	1.5xØ	0.5xØ	1.0xØ	0.017	0.023	0.028	0.032	0.039	
			42 HRc									
K	Grey	GG20, GG40, EN-GJL-250, No30B	150 HB	1.5xØ	0.5xØ	1.0xØ	0.037	0.051	0.061	0.071	0.085	
			200 HB									
	Malleable & Nodular	GGG40, GGG70, 50005	150 HB	1.5xØ	0.5xØ	1.0xØ	0.032	0.044	0.052	0.062	0.074	
			200 HB									
H	Steel	X100CrMo13, 440C, G-X260NiCr42	45 HRc	1.5xØ	0.3xØ	0.2xØ	0.014	0.019	0.022	0.026	0.031	
			50 HRc									
NF	Al (>8%Si)	AlSi12	130 HB	1.5xØ	0.5xØ	0.1xØ	0.034	0.046	0.055	0.065	0.077	

MACHINING CONDITIONS - SOLID END MILLS - DEPTH OF CUT AND FEED

90° 4 FLUTE, SHORT | LT 40 Ø 1 - 5

Material Group	Lamina Gr. N°	Material Examples	Hardness	Profiling		Slotting		fz [mm/tooth]				
				ap	ae	ap	Ø1.0	Ø2.0	Ø3.0	Ø4.0	Ø5.0	
P Non-Alloyed Low Alloyed High Alloyed	1	C35, Ck45, 1020, 1045, 1060, 28Mn6	125 HB	1.5xØ	0.5xØ	1.0xØ	0.008	0.010	0.014	0.019	0.024	
			190 HB									
			250 HB									
	2	42CrMo4, St50, Ck60, 4140, 4340, 100Cr6	180 HB	1.5xØ	0.5xØ	1.0xØ	0.008	0.009	0.013	0.020	0.024	
			230 HB									
			280 HB									
			350 HB									
	3	X40CrMoV5, H13, M42, D3, S6-5-2, 12Ni19	220 HB	1.5xØ	0.5xØ	1.0xØ	0.007	0.008	0.012	0.017	0.021	
			280 HB									
320 HB												
350 HB												
M Austenitic	4	304, 316, X5CrNi18-9	180 HB	1.5xØ	0.5xØ	1.0xØ	0.006	0.007	0.010	0.014	0.017	
			240 HB									
Ferritic & Martensitic	6	410, X6Cr17, 17-4 PH, 430	200 HB	1.5xØ	0.5xØ	1.0xØ	0.004	0.005	0.007	0.011	0.013	
			42 HRc									
K Grey Malleable & Nodular	7	GG20, GG40, EN-GJL-250, No30B	150 HB	1.5xØ	0.5xØ	1.0xØ	0.010	0.011	0.016	0.023	0.029	
			200 HB									
			250 HB									
	8	GGG40, GGG70, 50005	150 HB	1.5xØ	0.5xØ	1.0xØ	0.008	0.010	0.014	0.020	0.025	
			200 HB									
			250 HB									
H Steel	11	X100CrMo13, 440C, G-X260NiCr42	45 HRc 50 HRc	1.5xØ	0.3xØ	0.2xØ	0.003	0.004	0.005	0.009	0.011	
NF Al (>8%Si)	12	AlSi12	130 HB	1.5xØ	0.5xØ	0.1xØ	0.009	0.010	0.015	0.021	0.026	

90° 4 FLUTE, SHORT | LT 40 Ø 6, 8, 10, 12, 16

Material Group	Lamina Gr. N°	Material Examples	Hardness	Profiling		Slotting		fz [mm/tooth]				
				ap	ae	ap	Ø6.0	Ø8.0	Ø10.0	Ø12.0	Ø16.0	
P Non-Alloyed Low Alloyed High Alloyed	1	C35, Ck45, 1020, 1045, 1060, 28Mn6	125 HB	1.5xØ	0.5xØ	1.0xØ	0.032	0.044	0.052	0.062	0.084	
			190 HB									
			250 HB									
	2	42CrMo4, St50, Ck60, 4140, 4340, 100Cr6	180 HB	1.5xØ	0.5xØ	1.0xØ	0.031	0.042	0.050	0.059	0.074	
			230 HB									
			280 HB									
			350 HB									
	3	X40CrMoV5, H13, M42, D3, S6-5-2, 12Ni19	220 HB	1.5xØ	0.5xØ	1.0xØ	0.027	0.037	0.044	0.051	0.059	
			280 HB									
320 HB												
350 HB												
M Austenitic	4	304, 316, X5CrNi18-9	180 HB	1.5xØ	0.5xØ	1.0xØ	0.022	0.030	0.036	0.042	0.054	
			240 HB									
Ferritic & Martensitic	6	410, X6Cr17, 17-4 PH, 430	200 HB	1.5xØ	0.5xØ	1.0xØ	0.017	0.023	0.028	0.032	0.040	
			42 HRc									
K Grey Malleable & Nodular	7	GG20, GG40, EN-GJL-250, No30B	150 HB	1.5xØ	0.5xØ	1.0xØ	0.037	0.051	0.061	0.071	0.079	
			200 HB									
			250 HB									
	8	GGG40, GGG70, 50005	150 HB	1.5xØ	0.5xØ	1.0xØ	0.032	0.044	0.052	0.062	0.075	
			200 HB									
			250 HB									
H Steel	11	X100CrMo13, 440C, G-X260NiCr42	45 HRc 50 HRc	1.5xØ	0.3xØ	0.2xØ	0.014	0.019	0.022	0.026	0.029	
NF Al (>8%Si)	12	AlSi12	130 HB	1.5xØ	0.5xØ	0.1xØ	0.034	0.046	0.055	0.065	0.084	

MACHINING CONDITIONS - SOLID END MILLS - DEPTH OF CUT AND FEED

90° 4 FLUTE, LONG | LT 40 - Ø 3 - 6

Material Group	Lamina Gr. N°	Material Examples	Hardness	Profiling		Slotting		fz [mm/tooth]			
				ap	ae	ap	Ø3.0	Ø4.0	Ø5.0	Ø6.0	
P	Non-Alloyed	C35, Ck45, 1020, 1045, 1060, 28Mn6	125 HB	1.5xØ	0.5xØ	1.0xØ	0.013	0.023	0.023	0.029	
			190 HB								
			250 HB								
	Low Alloyed	2	42CrMo4, St50, Ck60, 4140, 4340, 100Cr6	180 HB	1.5xØ	0.5xØ	1.0xØ	0.011	0.016	0.020	0.026
				230 HB							
				280 HB			0.7xØ	0.009	0.013	0.016	0.020
				350 HB							
	High Alloyed	3	X40CrMoV5, H13, M42, D3, S6-5-2, 12Ni19	220 HB	1.5xØ	0.5xØ	1.0xØ	0.009	0.013	0.016	0.020
				280 HB							
320 HB				0.6xØ			0.006	0.009	0.011	0.015	
350 HB											
M	Austenitic	4	304, 316, X5CrNi18-9	180 HB	1.5xØ	0.5xØ	1.0xØ	0.008	0.012	0.015	0.019
				240 HB							
K	Ferritic & Martensitic	6	410, X6Cr17, 17-4 PH, 430	200 HB	1.5xØ	0.5xØ	1.0xØ	0.006	0.009	0.011	0.014
				42 HRc							
K	Grey	7	GG20, GG40, EN-GJL-250, No30B	150 HB	1.5xØ	0.5xØ	1.0xØ	0.012	0.017	0.022	0.028
				200 HB							
	Malleable & Nodular	8	GGG40, GGG70, 50005	150 HB	1.5xØ	0.5xØ	1.0xØ	0.011	0.017	0.021	0.026
				200 HB							
H	Steel	11	X100CrMo13, 440C, G-X260NiCr42	45 HRc 50 HRc	1.5xØ	0.3xØ	0.2xØ	0.004	0.006	0.008	0.010
NF	Al (>8%Si)	12	AlSi12	130 HB	1.5xØ	0.5xØ	0.1xØ	0.013	0.018	0.023	0.029

90° 4 FLUTE, LONG | LT 40 - Ø 8, 10, 12, 16

Material Group	Lamina Gr. N°	Material Examples	Hardness	Profiling		Slotting		fz [mm/tooth]			
				ap	ae	ap	Ø8.0	Ø10.0	Ø12.0	Ø16.0	
P	Non-Alloyed	C35, Ck45, 1020, 1045, 1060, 28Mn6	125 HB	1.5xØ	0.5xØ	1.0xØ	0.040	0.048	0.056	0.076	
			190 HB								
			250 HB								
	Low Alloyed	2	42CrMo4, St50, Ck60, 4140, 4340, 100Cr6	180 HB	1.5xØ	0.5xØ	1.0xØ	0.036	0.042	0.050	0.068
				230 HB							
				280 HB			0.7xØ	0.028	0.033	0.039	0.053
				350 HB							
	High Alloyed	3	X40CrMoV5, H13, M42, D3, S6-5-2, 12Ni19	220 HB	1.5xØ	0.5xØ	1.0xØ	0.028	0.033	0.039	0.053
				280 HB							
320 HB				0.6xØ			0.020	0.024	0.028	0.038	
350 HB											
M	Austenitic	4	304, 316, X5CrNi18-9	180 HB	1.5xØ	0.5xØ	1.0xØ	0.026	0.031	0.036	0.049
				240 HB							
K	Ferritic & Martensitic	6	410, X6Cr17, 17-4 PH, 430	200 HB	1.5xØ	0.5xØ	1.0xØ	0.019	0.023	0.027	0.036
				42 HRc							
K	Grey	7	GG20, GG40, EN-GJL-250, No30B	150 HB	1.5xØ	0.5xØ	1.0xØ	0.038	0.045	0.053	0.072
				200 HB							
	Malleable & Nodular	8	GGG40, GGG70, 50005	150 HB	1.5xØ	0.5xØ	1.0xØ	0.036	0.043	0.050	0.068
				200 HB							
H	Steel	11	X100CrMo13, 440C, G-X260NiCr42	45 HRc 50 HRc	1.5xØ	0.3xØ	0.2xØ	0.014	0.017	0.020	0.027
NF	Al (>8%Si)	12	AlSi12	130 HB	1.5xØ	0.5xØ	0.1xØ	0.040	0.048	0.056	0.076

MACHINING CONDITIONS - SOLID END MILLS - DEPTH OF CUT AND FEED

BALL NOSE 2 FLUTE | LT 40 - Ø 1 - 5

Material Group	Lamina Gr. N°	Material Examples*	Hardness	Contouring		fz [mm/tooth]				
				ap	ae	Ø1.0	Ø2.0	Ø3.0	Ø4.0	Ø5.0
P Non-Alloyed Low Alloyed High Alloyed	1	C35, Ck45, 1020, 1045, 1060, 28Mn6	125 HB	0.25xØ	0.7xØ	0.028	0.036	0.052	0.064	0.084
			190 HB							
			250 HB							
	2	42CrMo4, St50, Ck60, 4140, 4340, 100Cr6	180 HB	0.25xØ	0.7xØ	0.021	0.027	0.039	0.048	0.063
			230 HB							
			280 HB							
			350 HB							
	3	X40CrMoV5, H13, M42, D3, S6-5-2, 12Ni19	220 HB	0.25xØ	0.7xØ	0.018	0.023	0.033	0.040	0.053
			280 HB							
320 HB										
4	304, 316, X5CrNi18-9	180 HB	0.25xØ	0.7xØ	0.015	0.019	0.027	0.033	0.044	
		240 HB								
6	410, X6Cr17, 17-4 PH, 430	200 HB	0.25xØ	0.7xØ	0.015	0.020	0.028	0.035	0.046	
		42 HRC								
7	GG20, GG40, EN-GJL-250, No30B	150 HB	0.25xØ	0.7xØ	0.025	0.032	0.046	0.056	0.074	
		200 HB								
		250 HB								
8	GGG40, GGG70, 50005	150 HB	0.25xØ	0.7xØ	0.021	0.027	0.040	0.049	0.064	
		200 HB								
		250 HB								
11	X100CrMo13, 440C, G-X260NiCr42	45 HRC	0.25xØ	0.6xØ	0.009	0.012	0.017	0.020	0.027	
		50 HRC								
NF AI (>8%Si)	12	AlSi12	130 HB	0.25xØ	0.7xØ	0.022	0.029	0.042	0.051	0.067

BALL NOSE 2 FLUTE | LT 40 - Ø 6, 8, 10, 12, 16

Material Group	Lamina Gr. N°	Material Examples*	Hardness	Contouring		fz [mm/tooth]				
				ap	ae	Ø6.0	Ø8.0	Ø10.0	Ø12.0	Ø16.0
P Non-Alloyed Low Alloyed High Alloyed	1	C35, Ck45, 1020, 1045, 1060, 28Mn6	125 HB	0.25xØ	0.7xØ	0.080	0.092	0.100	0.112	0.106
			190 HB							
			250 HB							
	2	42CrMo4, St50, Ck60, 4140, 4340, 100Cr6	180 HB	0.25xØ	0.7xØ	0.060	0.069	0.075	0.084	0.080
			230 HB							
			280 HB							
			350 HB							
	3	X40CrMoV5, H13, M42, D3, S6-5-2, 12Ni19	220 HB	0.25xØ	0.7xØ	0.051	0.058	0.063	0.071	0.067
			280 HB							
320 HB										
350 HB										
4	304, 316, X5CrNi18-9	180 HB	0.25xØ	0.7xØ	0.042	0.048	0.052	0.058	0.055	
		240 HB								
6	410, X6Cr17, 17-4 PH, 430	200 HB	0.25xØ	0.7xØ	0.044	0.050	0.054	0.061	0.058	
		42 HRC								
7	GG20, GG40, EN-GJL-250, No30B	150 HB	0.25xØ	0.7xØ	0.070	0.081	0.088	0.099	0.093	
		200 HB								
		250 HB								
8	GGG40, GGG70, 50005	150 HB	0.25xØ	0.7xØ	0.061	0.070	0.076	0.085	0.081	
		200 HB								
		250 HB								
11	X100CrMo13, 440C, G-X260NiCr42	45 HRC	0.25xØ	0.6xØ	0.026	0.029	0.032	0.036	0.034	
		50 HRC								
NF AI (>8%Si)	12	AlSi12	130 HB	0.25xØ	0.7xØ	0.064	0.074	0.080	0.090	0.085

MACHINING CONDITIONS - SOLID END MILLS - DEPTH OF CUT AND FEED

90° 2 FLUTE | LT 4000 - Ø 1 - 5

Material Group	Lamina Gr. N°	Material Examples	Hardness	Profiling		Slotting		fz [mm/tooth]				
				ap	ae	ap	Ø 1	Ø 2	Ø 3	Ø 4	Ø 5	
P Non Alloyed Low Alloyed High Alloyed	1	C35, Ck45, 1020, 1045, 1060, 28Mn6	125 HB	1.5xØ	0.5xØ	1.0xØ	0.010	0.012	0.017	0.024	0.030	
			190 HB									
			250 HB									
	2	42CrMo4, S150, Ck60, 4140, 4340, 100Cr6	180 HB	1.5xØ	0.5xØ	1.0xØ	0.110	0.011	0.016	0.025	0.030	
			230 HB									
			280 HB									
			350 HB									
	3	X40CrMoV5, H13, M42, D3, S6-5-2, 12Ni19	220 HB	1.5xØ	0.5xØ	1.0xØ	0.009	0.010	0.015	0.021	0.026	
			280 HB									
320 HB												
350 HB												
M Austenitic Duplex Ferritic & Martensitic	4	304, 316, X5CrNi18-9	180 HB	1.5xØ	0.5xØ	1.0xØ	0.007	0.008	0.012	0.017	0.022	
			240 HB									
	5	X2CrNiN23-4, S31500	290 HB	1.5xØ	0.5xØ	1.0xØ	0.006	0.006	0.009	0.013	0.017	
			310 HB									
	6	410, X6Cr17, 17-4PH, 430	200 HB	1.5xØ	0.5xØ	1.0xØ	0.006	0.006	0.009	0.013	0.017	
			42 HRC									
K Grey Malleable & Nodular	7	GG20, GG40, EN-GJL-250, N030B	150 HB	1.5xØ	0.5xØ	1.0xØ	0.012	0.014	0.020	0.029	0.036	
			200 HB									
			250 HB									
	8	GG20, GG70, 50005	150 HB	1.5xØ	0.5xØ	1.0xØ	0.010	0.012	0.017	0.025	0.031	
200 HB												
250 HB												
S Fe, Ni & Co based Ti based	9	Incoloy 800 Inconel 700 Stellite 21	240 HB	1.5xØ	0.3xØ	1.0xØ	0.006	0.007	0.010	0.014	0.018	
			250 HB									
			350 HB									
			-									
	10	TiAl6V4 T40	-	1.5xØ	0.5xØ	1.0xØ	0.006	0.007	0.010	0.015	0.018	
-												
H Steel Chilled Cast Iron White Cast Iron	11	X100 CrMo13, 440C, G-X260NiCr42	45 HRC	1.5xØ	0.3xØ	0.2xØ	0.004	0.007	0.007	0.011	0.013	
			50 HRC									
			55 HRC									
	12	Ni-Hard 2	400 HB	1.5xØ	0.2xØ	0.1xØ	0.003	0.005	0.005	0.008	0.010	
			400 HB									
13	G-X300CrMo15	55 HRC	1.5xØ	0.2xØ	0.1xØ	0.003	0.005	0.005	0.008	0.010		
NF Aluminium	14	AlSi12	130 HB	1.5xØ	0.5xØ	1.0xØ	0.011	0.018	0.018	0.027	0.033	

90° 2 FLUTE | LT 4000 - Ø 6, 8, 10, 12

Material Group	Lamina Gr. N°	Material Examples	Hardness	Profiling		Slotting		fz [mm/tooth]			
				ap	ae	ap	Ø 6	Ø 8	Ø 10	Ø 12	
P Non Alloyed Low Alloyed High Alloyed	1	C35, Ck45, 1020, 1045, 1060, 28Mn6	125 HB	1.5xØ	0.5xØ	1.0xØ	0.040	0.055	0.065	0.077	
			190 HB								
			250 HB								
	2	42CrMo4, S150, Ck60, 4140, 4340, 100Cr6	180 HB	1.5xØ	0.5xØ	1.0xØ	0.039	0.053	0.063	0.074	
			230 HB								
			280 HB								
			350 HB								
	3	X40CrMoV5, H13, M42, D3, S6-5-2, 12Ni19	220 HB	1.5xØ	0.5xØ	1.0xØ	0.033	0.046	0.055	0.064	
			280 HB								
320 HB											
350 HB											
M Austenitic Duplex Ferritic & Martensitic	4	304, 316, X5CrNi18-9	180 HB	1.5xØ	0.5xØ	1.0xØ	0.028	0.038	0.045	0.053	
			240 HB								
	5	X2CrNiN23-4, S31500	290 HB	1.5xØ	0.5xØ	1.0xØ	0.021	0.029	0.035	0.040	
			310 HB								
	6	410, X6Cr17, 17-4PH, 430	200 HB	1.5xØ	0.5xØ	1.0xØ	0.021	0.029	0.035	0.040	
			42 HRC								
K Grey Malleable & Nodular	7	GG20, GG40, EN-GJL-250, N030B	150 HB	1.5xØ	0.5xØ	1.0xØ	0.047	0.064	0.076	0.089	
			200 HB								
			250 HB								
	8	GG20, GG70, 50005	150 HB	1.5xØ	0.5xØ	1.0xØ	0.040	0.055	0.066	0.077	
200 HB											
250 HB											
S Fe, Ni & Co based Ti based	9	Incoloy 800 Inconel 700 Stellite 21	240 HB	1.5xØ	0.3xØ	1.0xØ	0.023	0.031	0.037	0.044	
			250 HB								
			350 HB								
			-								
	10	TiAl6V4 T40	-	1.5xØ	0.5xØ	1.0xØ	0.023	0.032	0.038	0.045	
-											
H Steel Chilled Cast Iron White Cast Iron	11	X100 CrMo13, 440C, G-X260NiCr42	45 HRC	1.5xØ	0.3xØ	0.2xØ	0.017	0.023	0.028	0.032	
			50 HRC								
			55 HRC								
	12	Ni-Hard 2	400 HB	1.5xØ	0.2xØ	0.1xØ	0.013	0.017	0.021	0.024	
			400 HB								
13	G-X300CrMo15	55 HRC	1.5xØ	0.2xØ	0.1xØ	0.013	0.017	0.021	0.024		
NF Aluminium	14	AlSi12	130 HB	1.5xØ	0.5xØ	1.0xØ	0.042	0.058	0.069	0.081	

MACHINING CONDITIONS - SOLID END MILLS - DEPTH OF CUT AND FEED

90° 3 FLUTE | LT 4000 - Ø 3 - 6, 8, 10, 12

Material Group	Lamina Gr. N°	Material Examples	Hardness	Profiling		Slotting		fz [mm/tooth]						
				ap	ae	ap	Ø 3	Ø 4	Ø 5	Ø 6	Ø 8	Ø 10	Ø 12	
P Non Aligned Low Aligned High Aligned	1	C35, Ck45, 1020, 1045, 1060, 28Mn6	125 HB	1.5xØ	0.5xØ	1.0xØ	0.018	0.027	0.033	0.042	0.058	0.069	0.081	
			190 HB											
			250 HB											
	2	42CrMo4, St50, Ck60, 4140, 4340, 100Cr6	180 HB	1.5xØ	0.5xØ	1.0xØ	0.017	0.025	0.031	0.040	0.054	0.065	0.076	
			230 HB											
			280 HB			0.7xØ	0.015	0.021	0.026	0.034	0.046	0.055	0.065	
			350 HB											
	3	X40CrMoV5, H13, M42, D3, S6-5-2, 12Ni19	220 HB	1.5xØ	0.5xØ	1.0xØ	0.015	0.021	0.026	0.033	0.046	0.055	0.064	
			280 HB											
320 HB			0.6xØ			0.011	0.016	0.020	0.025	0.035	0.041	0.049		
350 HB														
M Austenitic Duplex Ferritic & Martensitic	4	304, 316, X5CrNi18-9	180 HB	1.5xØ	0.5xØ	1.0xØ	0.012	0.017	0.022	0.028	0.038	0.045	0.053	
			240 HB											
	5	X2CrNiN23-4, S31500	290 HB	1.5xØ	0.5xØ	1.0xØ	0.009	0.013	0.017	0.021	0.029	0.035	0.040	
			310 HB											
	6	410, X6Cr17, 17-4PH, 430	200 HB	1.5xØ	0.5xØ	1.0xØ	0.009	0.013	0.016	0.020	0.028	0.033	0.039	
			42 HRc											
K Grey Malleable & Nodular	7	GG20, GG40, EN-GJL-250, N030B	150 HB	1.5xØ	0.5xØ	1.0xØ	0.020	0.029	0.036	0.047	0.064	0.076	0.089	
			200 HB											
			250 HB											
8	GGG40, GGG70, S0005	150 HB	1.5xØ	0.5xØ	1.0xØ	0.017	0.025	0.031	0.040	0.055	0.066	0.077		
		200 HB												
		250 HB												
S Fe, Ni & Co based Ti based	9	Incoloy 800	1.5xØ	0.3xØ	1.0xØ	0.010	0.014	0.018	0.023	0.031	0.037	0.044		
		Inconel 700												
		Stellite 21												
10	T40	-	1.5xØ	0.5xØ	1.0xØ	0.007	0.011	0.013	0.017	0.023	0.028	0.032		
	TiAl6V4	-												
H Steel Chilled Cast Iron White Cast Iron	11	X100CrMo13, 440C, G-X260NiCr42	45 HRc	1.5xØ	0.3xØ	0.2xØ	0.006	0.009	0.012	0.015	0.020	0.024	0.028	
			50 HRc											
			55 HRc		0.2xØ	0.1xØ	0.006	0.008	0.010	0.013	0.017	0.021	0.024	
12	Ni-Hard 2	400 HB	1.5xØ	0.2xØ	0.1xØ	0.006	0.008	0.010	0.013	0.017	0.021	0.024		
13	G-X300CrMo15	55 HRc	1.5xØ	0.2xØ	0.1xØ	0.006	0.008	0.010	0.013	0.017	0.021	0.024		
NF Aluminium	14	AlSi12	130 HB	1.5xØ	0.5xØ	1.0xØ	0.018	0.027	0.033	0.042	0.058	0.0696	0.081	

MACHINING CONDITIONS - SOLID END MILLS - DEPTH OF CUT AND FEED

90° 4 FLUTE | LT 4000 - Ø 1 - 5

Material Group	Lamina Gr. N°	Material Examples	Hardness	Profiling		Slotting		fz [mm/tooth]				
				ap	ae	ap	Ø 1	Ø 2	Ø 3	Ø 4	Ø 5	
P Non Alloyed Low Alloyed High Alloyed	1	C35, Ck45, 1020, 1045, 1060, 28Mn6	125 HB	1.5xØ	0.5xØ	1.0xØ	0.010	0.011	0.016	0.023	0.029	
			190 HB									
			250 HB									
	2	42CrMo4, St50, Ck60, 4140, 4340, 100Cr6	180 HB	1.5xØ	0.5xØ	1.0xØ	0.008	0.010	0.014	0.020	0.025	
			230 HB									
			280 HB									
			350 HB									
	3	X40CrMoV5, H13, M42, D3, S6-5-2, 12Ni19	220 HB	1.5xØ	0.5xØ	1.0xØ	0.007	0.008	0.011	0.016	0.020	
			280 HB									
320 HB												
4	304, 316, X5CrNi18-9	180 HB	1.5xØ	0.5xØ	1.0xØ	0.006	0.007	0.010	0.015	0.019		
		240 HB										
		290 HB										
5	X2CrNiN23-4, S31500	290 HB	1.5xØ	0.5xØ	1.0xØ	0.005	0.006	0.008	0.011	0.014		
		310 HB										
		200 HB										
6	410, X6Cr17, 17-4PH, 430	200 HB	1.5xØ	0.5xØ	1.0xØ	0.005	0.005	0.008	0.011	0.014		
		42 HRc										
		150 HB										
7	GG20, GG40, EN-GJL-250, N030B	200 HB	1.5xØ	0.5xØ	1.0xØ	0.009	0.011	0.015	0.022	0.027		
		250 HB										
		250 HB										
8	GGG40, GGG70, 50005	150 HB	1.5xØ	0.5xØ	1.0xØ	0.009	0.010	0.014	0.021	0.026		
		200 HB										
		250 HB										
9	Incoloy 800	240 HB	1.5xØ	0.3xØ	1.0xØ	0.004	0.004	0.006	0.009	0.011		
		Inconel 700										
		250 HB										
		350 HB										
10	Ti based	T40	1.5xØ	0.5xØ	1.0xØ	0.004	0.004	0.006	0.009	0.011		
		TiAl6V4										
		-										
11	Steel	X100CrMo13, 440C, G-X260NiCr42	45 HRc	1.5xØ	0.3xØ	0.2xØ	0.003	0.004	0.006	0.008	0.010	
			50 HRc									
			55 HRc									
			0.2xØ									
12	Chilled Cast Iron	Ni-Hard 2	400 HB	1.5xØ	0.2xØ	0.1xØ	0.003	0.003	0.005	0.007	0.009	
			55 HRc									
13	White Cast Iron	G-X300CrMo15	55 HRc	1.5xØ	0.2xØ	0.1xØ	0.003	0.003	0.005	0.007	0.009	
14	NF Aluminium	AlSi12	130 HB	1.5xØ	0.5xØ	1.0xØ	0.010	0.011	0.016	0.023	0.029	

90° 4 FLUTE | LT 4000 - Ø 6, 8, 10, 12, 16

Material Group	Lamina Gr. N°	Material Examples	Hardness	Profiling		Slotting		fz [mm/tooth]				
				ap	ae	ap	Ø 6	Ø 8	Ø 10	Ø 12	Ø 16	
P Non Alloyed Low Alloyed High Alloyed	1	C35, Ck45, 1020, 1045, 1060, 28Mn6	125 HB	1.5xØ	0.5xØ	1.0xØ	0.050	0.059	0.070	0.099	0.095	
			190 HB									
			250 HB									
	2	42CrMo4, St50, Ck60, 4140, 4340, 100Cr6	180 HB	1.5xØ	0.5xØ	1.0xØ	0.044	0.053	0.062	0.088	0.085	
			230 HB									
			280 HB									
			350 HB									
	3	X40CrMoV5, H13, M42, D3, S6-5-2, 12Ni19	220 HB	1.5xØ	0.5xØ	1.0xØ	0.035	0.042	0.049	0.069	0.067	
			280 HB									
320 HB												
4	304, 316, X5CrNi18-9	180 HB	1.5xØ	0.5xØ	1.0xØ	0.032	0.039	0.045	0.064	0.062		
		240 HB										
		290 HB										
5	X2CrNiN23-4, S31500	290 HB	1.5xØ	0.5xØ	1.0xØ	0.025	0.030	0.035	0.050	0.048		
		310 HB										
		200 HB										
6	410, X6Cr17, 17-4PH, 430	200 HB	1.5xØ	0.5xØ	1.0xØ	0.024	0.029	0.033	0.048	0.046		
		42 HRc										
		150 HB										
7	Grey	GG20, GG40, EN-GJL-250, N030B	200 HB	1.5xØ	0.5xØ	1.0xØ	0.047	0.056	0.066	0.094	0.090	
			250 HB									
			250 HB									
8	K Malleable & Nodular	GGG40, GGG70, 50005	150 HB	1.5xØ	0.5xØ	1.0xØ	0.045	0.053	0.063	0.089	0.086	
			200 HB									
			250 HB									
9	S Fe, Ni & Co based	Incoloy 800	240 HB	1.5xØ	0.3xØ	1.0xØ	0.020	0.024	0.028	0.040	0.038	
			Inconel 700									
			250 HB									
			350 HB									
10	Ti based	Ti based	T40	1.5xØ	0.5xØ	1.0xØ	0.020	0.024	0.028	0.040	0.038	
			TiAl6V4									
			-									
11	H Steel	X100CrMo13, 440C, G-X260NiCr42	45 HRc	1.5xØ	0.3xØ	0.2xØ	0.017	0.021	0.024	0.035	0.033	
			50 HRc									
			55 HRc									
			0.2xØ									
12	Chilled Cast Iron	Ni-Hard 2	400 HB	1.5xØ	0.2xØ	0.1xØ	0.015	0.018	0.021	0.030	0.029	
			55 HRc									
13	White Cast Iron	G-X300CrMo15	55 HRc	1.5xØ	0.2xØ	0.1xØ	0.015	0.018	0.021	0.030	0.029	
14	NF Aluminium	AlSi12	130 HB	1.5xØ	0.5xØ	1.0xØ	0.050	0.059	0.070	0.099	0.095	

MACHINING CONDITIONS - SOLID END MILLS - DEPTH OF CUT AND FEED

90° 4 FLUTE, LONG | LT 4000 - Ø 1 - 5

Material Group	Lamina Gr. N°	Material Examples	Hardness	Profiling		Slotting		fz [mm/tooth]				
				ap	ae	ap	Ø 1	Ø 2	Ø 3	Ø 4	Ø 5	
P Non Alloyed Low Alloyed High Alloyed	1	C35, Ck45, 1020, 1045, 1060, 28Mn6	125 HB	1.5xØ	0.5xØ	1.0xØ	0.010	0.011	0.016	0.023	0.029	
			190 HB									
			250 HB									
	2	42CrMo4, St50, Ck60, 4140, 4340, 100Cr6	180 HB	1.5xØ	0.5xØ	1.0xØ	0.008	0.010	0.014	0.020	0.025	
			230 HB									
			280 HB									
			350 HB									
	3	X40CrMoV5, H13, M42, D3, S6-5-2, 12Ni19	220 HB	1.5xØ	0.5xØ	1.0xØ	0.007	0.008	0.011	0.016	0.020	
			280 HB									
320 HB												
350 HB												
M Austenitic	4	304, 316, X5CrNi18-9	180 HB	1.5xØ	0.5xØ	1.0xØ	0.006	0.007	0.010	0.015	0.019	
			240 HB									
	5	X2CrNiN23-4, S31500	290 HB	1.5xØ	0.5xØ	1.0xØ	0.005	0.006	0.008	0.011	0.014	
M Ferritic & Martensitic	6	410, X6Cr17, 17-4PH, 430	200 HB	1.5xØ	0.5xØ	1.0xØ	0.005	0.005	0.008	0.011	0.014	
			42 HRc									
K Grey Malleable & Nodular	7	GG20, GG40, EN-GJL-250, N030B	150 HB	1.5xØ	0.5xØ	1.0xØ	0.009	0.011	0.015	0.022	0.027	
			200 HB									
			250 HB									
	8	GGG40, GGG70, 50005	150 HB	1.5xØ	0.5xØ	1.0xØ	0.009	0.010	0.014	0.021	0.026	
S Fe, Ni & Co based Ti based	9	Incoloy 800, Inconel 700, Stellite 21	240 HB	1.5xØ	0.3xØ	1.0xØ	0.004	0.004	0.006	0.009	0.011	
			250 HB									
			350 HB									
	10	Ti40, TiAl6V4	-	1.5xØ	0.5xØ	1.0xØ	0.004	0.004	0.006	0.009	0.011	
H Steel Chilled Cast Iron White Cast Iron	11	X100CrMo13, 440C, G-X260NiCr42	45 HRc	1.5xØ	0.3xØ	0.2xØ	0.003	0.004	0.006	0.008	0.010	
			50 HRc									
			55 HRc									
	12	Ni-Hard 2	400 HB	1.5xØ	0.2xØ	0.1xØ	0.003	0.003	0.005	0.007	0.009	
13	G-X300CrMo15	55 HRc	1.5xØ	0.2xØ	0.1xØ	0.003	0.003	0.005	0.007	0.009		
NF Aluminium	14	AlSi12	130 HB	1.5xØ	0.5xØ	1.0xØ	0.010	0.011	0.016	0.023	0.029	

90° 4 FLUTE, LONG | LT 4000 - Ø 6, 8, 10, 12, 16

Material Group	Lamina Gr. N°	Material Examples	Hardness	Profiling		Slotting		fz [mm/tooth]				
				ap	ae	ap	Ø 6	Ø 8	Ø 10	Ø 12	Ø 16	
P Non Alloyed Low Alloyed High Alloyed	1	C35, Ck45, 1020, 1045, 1060, 28Mn6	125 HB	1.5xØ	0.5xØ	1.0xØ	0.036	0.050	0.059	0.070	0.090	
			190 HB									
			250 HB									
	2	42CrMo4, St50, Ck60, 4140, 4340, 100Cr6	180 HB	1.5xØ	0.5xØ	1.0xØ	0.032	0.044	0.053	0.062	0.088	
			230 HB									
			280 HB									
			350 HB									
	3	X40CrMoV5, H13, M42, D3, S6-5-2, 12Ni19	220 HB	1.5xØ	0.5xØ	1.0xØ	0.026	0.035	0.042	0.049	0.069	
			280 HB									
320 HB												
350 HB												
M Austenitic	4	304, 316, X5CrNi18-9	180 HB	1.5xØ	0.5xØ	1.0xØ	0.024	0.032	0.039	0.045	0.064	
			240 HB									
	5	X2CrNiN23-4, S31500	290 HB	1.5xØ	0.5xØ	1.0xØ	0.018	0.025	0.030	0.035	0.050	
M Ferritic & Martensitic	6	410, X6Cr17, 17-4PH, 430	200 HB	1.5xØ	0.5xØ	1.0xØ	0.017	0.024	0.029	0.033	0.048	
			42 HRc									
K Grey Malleable & Nodular	7	GG20, GG40, EN-GJL-250, N030B	150 HB	1.5xØ	0.5xØ	1.0xØ	0.035	0.047	0.056	0.066	0.094	
			200 HB									
			250 HB									
	8	GGG40, GGG70, 50005	150 HB	1.5xØ	0.5xØ	1.0xØ	0.033	0.045	0.053	0.063	0.089	
S Fe, Ni & Co based Ti based	9	Incoloy 800, Inconel 700, Stellite 21	240 HB	1.5xØ	0.3xØ	1.0xØ	0.015	0.020	0.024	0.028	0.040	
			250 HB									
			350 HB									
	10	Ti40, TiAl6V4	-	1.5xØ	0.5xØ	1.0xØ	0.015	0.020	0.024	0.028	0.040	
H Steel Chilled Cast Iron White Cast Iron	11	X100CrMo13, 440C, G-X260NiCr42	45 HRc	1.5xØ	0.3xØ	0.2xØ	0.013	0.017	0.021	0.024	0.035	
			50 HRc									
			55 HRc									
	12	Ni-Hard 2	400 HB	1.5xØ	0.2xØ	0.1xØ	0.011	0.015	0.018	0.021	0.030	
13	G-X300CrMo15	55 HRc	1.5xØ	0.2xØ	0.1xØ	0.011	0.015	0.018	0.021	0.030		
NF Aluminium	14	AlSi12	130 HB	1.5xØ	0.5xØ	1.0xØ	0.036	0.050	0.059	0.070	0.099	

MACHINING CONDITIONS - SOLID END MILLS - DEPTH OF CUT AND FEED

E90° 4 FLUTE WITH RADIUS 0.5 | LT 4000 - Ø 3 - 6, 8, 10, 12

Material Group	Lamina Gr. N°	Material Examples	Hardness	Profiling		Slotting		fz [mm/tooth]					
				ap	ae	ap	Ø 3	Ø 4	Ø 5	Ø 6	Ø 8	Ø 10	Ø 12
P Non Alloyed Low Alloyed High Alloyed	1	C35, Ck45, 1020, 1045, 1060, 28Mn6	125 HB	1.5xØ	0.5xØ	1.0xØ	0.017	0.024	0.030	0.040	0.055	0.065	0.077
			190 HB										
			250 HB										
	2	42CrMo4, S150, Ck60, 4140, 4340, 100Cr6	180 HB	1.5xØ	0.5xØ	1.0xØ	0.160	0.025	0.030	0.039	0.053	0.063	0.074
			230 HB										
			280 HB										
			350 HB										
	3	X40CrMoV5, H13, M42, D3, S6-5-2, 12Ni19	220 HB	1.5xØ	0.5xØ	1.0xØ	0.015	0.021	0.026	0.033	0.046	0.055	0.064
			280 HB										
320 HB													
350 HB													
M Austenitic Duplex Ferritic & Martensitic	4	304, 316, X5CrNi18-9	180 HB	1.5xØ	0.5xØ	1.0xØ	0.012	0.017	0.022	0.028	0.038	0.045	0.053
			240 HB										
	5	X2CrNiN23-4, S31500	290 HB	1.5xØ	0.5xØ	1.0xØ	0.009	0.013	0.017	0.021	0.029	0.035	0.040
			310 HB										
	6	410, X6Cr17, 17-4PH, 430	200 HB	1.5xØ	0.5xØ	1.0xØ	0.009	0.013	0.017	0.021	0.029	0.035	0.040
			42 HRC										
K Grey Malleable & Nodular	7	GG20, GG40, EN-GJL-250, N030B	150 HB	1.5xØ	0.5xØ	1.0xØ	0.020	0.029	0.036	0.047	0.064	0.076	0.089
			200 HB										
			250 HB										
	8	GG20, GG70, 50005	150 HB	1.5xØ	0.5xØ	1.0xØ	0.017	0.025	0.031	0.040	0.055	0.066	0.077
200 HB													
250 HB													
S Fe, Ni & Co based Ti based	9	Incoloy 800	240 HB	1.5xØ	0.3xØ	1.0xØ	0.010	0.014	0.018	0.023	0.031	0.037	0.044
			Inconel 700										
			Stellite 21										
	10	TiAl6V4	-	1.5xØ	0.5xØ	1.0xØ	0.010	0.015	0.018	0.023	0.032	0.038	0.045
			T40										
H Steel Chilled Cast Iron White Cast Iron	11	X100 CrMo13, 440C, G-X260NiCr42	45 HRC	1.5xØ	0.3xØ	0.2xØ	0.007	0.011	0.013	0.017	0.023	0.028	0.032
			50 HRC										
			55 HRC										
	12	Ni-Hard 2	400 HB	1.5xØ	0.2xØ	0.1xØ	0.005	0.008	0.010	0.013	0.017	0.021	0.024
55 HRC													
13	G-X300CrMo15	55 HRC	1.5xØ	0.2xØ	0.1xØ	0.005	0.008	0.010	0.013	0.017	0.021	0.024	
NF Aluminium	14	AlSi12	130 HB	1.5xØ	0.5xØ	1.0xØ	0.018	0.027	0.033	0.042	0.058	0.069	0.081

E90° 4 FLUTE WITH RADIUS 1.0 | LT 4000 - Ø 3 - 6, 8, 10, 12

Material Group	Lamina Gr. N°	Material Examples	Hardness	Profiling		Slotting		fz [mm/tooth]					
				ap	ae	ap	Ø 3	Ø 4	Ø 5	Ø 6	Ø 8	Ø 10	Ø 12
P Non Alloyed Low Alloyed High Alloyed	1	C35, Ck45, 1020, 1045, 1060, 28Mn6	125 HB	1.5xØ	0.5xØ	1.0xØ	0.017	0.024	0.030	0.040	0.055	0.065	0.077
			190 HB										
			250 HB										
	2	42CrMo4, S150, Ck60, 4140, 4340, 100Cr6	180 HB	1.5xØ	0.5xØ	1.0xØ	0.160	0.025	0.030	0.039	0.053	0.063	0.074
			230 HB										
			280 HB										
			350 HB										
	3	X40CrMoV5, H13, M42, D3, S6-5-2, 12Ni19	220 HB	1.5xØ	0.5xØ	1.0xØ	0.015	0.021	0.026	0.033	0.046	0.055	0.064
			280 HB										
320 HB													
350 HB													
M Austenitic Duplex Ferritic & Martensitic	4	304, 316, X5CrNi18-9	180 HB	1.5xØ	0.5xØ	1.0xØ	0.012	0.017	0.022	0.028	0.038	0.045	0.053
			240 HB										
	5	X2CrNiN23-4, S31500	290 HB	1.5xØ	0.5xØ	1.0xØ	0.009	0.013	0.017	0.021	0.029	0.035	0.040
			310 HB										
	6	410, X6Cr17, 17-4PH, 430	200 HB	1.5xØ	0.5xØ	1.0xØ	0.009	0.013	0.017	0.021	0.029	0.035	0.040
			42 HRC										
K Grey Malleable & Nodular	7	GG20, GG40, EN-GJL-250, N030B	150 HB	1.5xØ	0.5xØ	1.0xØ	0.020	0.029	0.036	0.047	0.064	0.076	0.089
			200 HB										
			250 HB										
	8	GGG40, GGG70, 50005	150 HB	1.5xØ	0.5xØ	1.0xØ	0.017	0.025	0.031	0.040	0.055	0.066	0.077
200 HB													
250 HB													
S Fe, Ni & Co based Ti based	9	Incoloy 800	240 HB	1.5xØ	0.3xØ	1.0xØ	0.010	0.014	0.018	0.023	0.031	0.037	0.044
			Inconel 700										
			Stellite 21										
	10	TiAl6V4	-	1.5xØ	0.5xØ	1.0xØ	0.010	0.015	0.018	0.023	0.032	0.038	0.045
			T40										
H Steel Chilled Cast Iron White Cast Iron	11	X100 CrMo13, 440C, G-X260NiCr42	45 HRC	1.5xØ	0.3xØ	0.2xØ	0.007	0.011	0.013	0.017	0.023	0.028	0.032
			50 HRC										
			55 HRC										
	12	Ni-Hard 2	400 HB	1.5xØ	0.2xØ	0.1xØ	0.005	0.008	0.010	0.013	0.017	0.021	0.024
55 HRC													
13	G-X300CrMo15	55 HRC	1.5xØ	0.2xØ	0.1xØ	0.005	0.008	0.010	0.013	0.017	0.021	0.024	
NF Aluminium	14	AlSi12	130 HB	1.5xØ	0.5xØ	1.0xØ	0.018	0.027	0.033	0.042	0.058	0.069	0.081

MACHINING CONDITIONS - SOLID END MILLS - DEPTH OF CUT AND FEED

90° 4 FLUTE WITH RADIUS 2.0 | LT 4000 - Ø 6, 8, 10, 12

Material Group	Lamina Gr. N°	Material Examples	Hardness	Profiling		Slotting		fz [mm/tooth]			
				ap	ae	ap	Ø 6	Ø 8	Ø 10	Ø 12	
P Non Alloyed Low Alloyed High Alloyed	1	C35, Ck45, 1020, 1045, 1060, 28Mn6	125 HB	1.5xØ	0.5xØ	1.0xØ	0.040	0.055	0.065	0.077	
			190 HB								
			250 HB								
	2	42CrMo4, St50, Ck60, 4140, 4340, 100Cr6	180 HB	1.5xØ	0.5xØ	1.0xØ	0.039	0.053	0.063	0.074	
			230 HB								
			280 HB								
350 HB											
3	X40CrMoV5, H13, M42, D3, S6-5-2, 12Ni19	220 HB	1.5xØ	0.5xØ	1.0xØ	0.033	0.046	0.055	0.064		
		280 HB									
		320 HB									
		350 HB									
M Austenitic Duplex Ferritic & Martensitic	4	304, 316, X5CrNi18-9	180 HB	1.5xØ	0.5xØ	1.0xØ	0.028	0.038	0.045	0.053	
			240 HB								
	5	X2CrNiN23-4, S31500	290 HB	1.5xØ	0.5xØ	1.0xØ	0.021	0.029	0.035	0.040	
			310 HB								
	6	410, X6Cr17, 17-4PH, 430	200 HB	1.5xØ	0.5xØ	1.0xØ	0.021	0.029	0.035	0.040	
			42 HRc								
K Grey Malleable & Nodular	7	GG20, GG40, EN-GJL-250, N030B	150 HB	1.5xØ	0.5xØ	1.0xØ	0.047	0.064	0.076	0.089	
			200 HB								
			250 HB								
	8	GGG40, GGG70, 50005	150 HB	1.5xØ	0.5xØ	1.0xØ	0.040	0.055	0.066	0.077	
200 HB											
250 HB											
S Fe, Ni & Co based Ti based	9	Incoloy 800	1.5xØ	0.3xØ	1.0xØ	0.023	0.031	0.037	0.044		
		Inconel 700									
		Stellite 21									
	10	T40	1.5xØ	0.5xØ	1.0xØ	0.023	0.032	0.038	0.045		
TiAl6V4											
H Steel Chilled Cast Iron White Cast Iron	11	X100CrMo13, 440C, G-X260NiCr42	45 HRc	1.5xØ	0.3xØ	0.2xØ	0.017	0.023	0.028	0.032	
			50 HRc								
			55 HRc								
	12	Ni-Hard 2	400 HB	1.5xØ	0.2xØ	0.1xØ	0.013	0.017	0.021	0.024	
400 HB											
13	G-X300CrMo15	55 HRc	1.5xØ	0.2xØ	0.1xØ	0.013	0.017	0.021	0.024		
		55 HRc									
NF Aluminium	14	AlSi12	130 HB	1.5xØ	0.5xØ	1.0xØ	0.042	0.058	0.069	0.081	

90° 4 FLUTE WITH RADIUS 0.5, LONG | LT 4000 - Ø 8, 10, 12

Material Group	Lamina Gr. N°	Material Examples	Hardness	Profiling		Slotting		fz [mm/tooth]		
				ap	ae	ap	Ø 8	Ø 10	Ø 12	
P Non Alloyed Low Alloyed High Alloyed	1	C35, Ck45, 1020, 1045, 1060, 28Mn6	125 HB	3.0xØ	0.25xØ	1.0xØ	0.050	0.059	0.070	
			190 HB							
			250 HB							
	2	42CrMo4, St50, Ck60, 4140, 4340, 100Cr6	180 HB	3.0xØ	0.25xØ	1.0xØ	0.044	0.053	0.062	
			230 HB							
			280 HB							
350 HB										
3	X40CrMoV5, H13, M42, D3, S6-5-2, 12Ni19	220 HB	3.0xØ	0.25xØ	0.7xØ	0.035	0.042	0.049		
		280 HB								
		320 HB								
		350 HB								
M Austenitic Duplex Ferritic & Martensitic	4	304, 316, X5CrNi18-9	180 HB	3.0xØ	0.25xØ	1.0xØ	0.032	0.039	0.045	
			240 HB							
	5	X2CrNiN23-4, S31500	290 HB	3.0xØ	0.25xØ	1.0xØ	0.025	0.030	0.035	
			310 HB							
	6	410, X6Cr17, 17-4PH, 430	200 HB	3.0xØ	0.25xØ	1.0xØ	0.024	0.029	0.033	
			42 HRc							
K Grey Malleable & Nodular	7	GG20, GG40, EN-GJL-250, N030B	150 HB	3.0xØ	0.25xØ	1.0xØ	0.047	0.056	0.066	
			200 HB							
			250 HB							
	8	GGG40, GGG70, 50005	150 HB	3.0xØ	0.25xØ	1.0xØ	0.045	0.053	0.063	
200 HB										
250 HB										
S Fe, Ni & Co based Ti based	9	Incoloy 800	3.0xØ	0.10xØ	1.0xØ	0.020	0.024	0.028		
		Inconel 700								
		Stellite 21								
	10	T40	3.0xØ	0.25xØ	1.0xØ	0.020	0.024	0.028		
TiAl6V4										
H Steel Chilled Cast Iron White Cast Iron	11	X100CrMo13, 440C, G-X260NiCr42	45 HRc	3.0xØ	0.10xØ	0.1xØ	0.017	0.021	0.024	
			50 HRc							
			55 HRc							
	12	Ni-Hard 2	400 HB	3.0xØ	0.10xØ	0.1xØ	0.015	0.018	0.021	
400 HB										
13	G-X300CrMo15	55 HRc	3.0xØ	0.10xØ	0.1xØ	0.015	0.018	0.021		
		55 HRc								
NF Aluminium	14	AlSi12	130 HB	3.0xØ	0.25xØ	1.0xØ	0.050	0.050	0.070	

MACHINING CONDITIONS - SOLID END MILLS - DEPTH OF CUT AND FEED

BALL NOSE, 2 FLUTE | LT 4000 - Ø 1 - 6, 8, 10, 12

Material Group	Lamina Gr. N°	Material Examples	Hardness	Profiling		Slotting		fz [mm/tooth]							
				ap	ae	ap	Ø 1	Ø 2	Ø 3	Ø 4	Ø 5	Ø 6	Ø 8	Ø 10	Ø 12
P Non Alloyed	1	C35, Ck45, 1020, 1045, 1060, 28Mn6	125 HB	1.5xØ	0.5xØ	1.0xØ	0.035	0.045	0.065	0.080	0.105	0.100	0.115	0.125	0.140
			190 HB												
			250 HB												
P Low Alloyed	2	42CrMo4, S150, Ck60, 4140, 4340, 100Cr6	180 HB	1.5xØ	0.5xØ	1.0xØ	0.033	0.042	0.061	0.075	0.099	0.094	0.108	0.118	0.132
			230 HB												
			280 HB												
			350 HB												
P High Alloyed	3	X40CrMoV5, H13, M42, D3, S6-5-2, 12Ni19	220 HB	1.5xØ	0.5xØ	1.0xØ	0.028	0.036	0.051	0.063	0.083	0.079	0.091	0.099	0.111
			280 HB												
			320 HB												
			350 HB												
M Austenitic	4	304, 316, X5CrNi18-9	180 HB	1.5xØ	0.5xØ	1.0xØ	0.023	0.029	0.042	0.052	0.068	0.065	0.075	0.081	0.091
			240 HB												
			290 HB												
M Duplex	5	X2CrNiN23-4, S31500	290 HB	1.5xØ	0.5xØ	1.0xØ	0.018	0.023	0.033	0.040	0.053	0.050	0.058	0.063	0.070
			310 HB												
M Ferritic & Martensitic	6	410, X6Cr17, 17-4PH, 430	200 HB	1.5xØ	0.5xØ	1.0xØ	0.024	0.031	0.044	0.054	0.071	0.068	0.078	0.085	0.095
			42 HRC												
K Grey	7	GG20, GG40, EN-GJL-250, N030B	150 HB	1.5xØ	0.5xØ	1.0xØ	0.039	0.050	0.072	0.088	0.116	0.110	0.127	0.138	0.154
			200 HB												
			250 HB												
K Malleable & Nodular	8	GGG40, GGG70, 50005	150 HB	1.5xØ	0.5xØ	1.0xØ	0.033	0.043	0.062	0.076	0.100	0.095	0.109	0.119	0.133
			200 HB												
			250 HB												
S Fe, Ni & Co based	9	Incoloy 800, Inconel 700, Stellite 21	240 HB	1.5xØ	0.3xØ	1.0xØ	0.022	0.029	0.042	0.051	0.067	0.064	0.074	0.080	0.090
			250 HB												
			350 HB												
S Ti based	10	T40, TiAl6V4	-	1.5xØ	0.5xØ	1.0xØ	0.019	0.025	0.036	0.044	0.058	0.055	0.063	0.069	0.077
			-												
H Steel	11	X100CrMo13, 440C, G-X260NiCr42	45 HRC	1.5xØ	0.3xØ	0.2xØ	0.014	0.018	0.026	0.032	0.042	0.040	0.046	0.050	0.056
			50 HRC												
			55 HRC												
H Chilled Cast Iron	12	Ni-Hard 2	400 HB	1.5xØ	0.2xØ	0.1xØ	0.011	0.014	0.020	0.024	0.032	0.030	0.035	0.038	0.042
			55 HRC												
H White Cast Iron	13	G-X300CrMo15	55 HRC	1.5xØ	0.2xØ	0.1xØ	0.011	0.014	0.020	0.024	0.032	0.030	0.035	0.038	0.042
NF Aluminium	14	AlSi12	130 HB	1.5xØ	0.5xØ	1.0xØ	0.035	0.045	0.065	0.080	0.105	0.100	0.115	0.125	0.140

ROUGHER, 3 - 4 FLUTE | LT 4000 - Ø 4 - 6, 8, 10, 12

Material Group	Lamina Gr. N°	Material Examples	Hardness	Profiling		Slotting		fz [mm/tooth]					
				ap	ae	ap	Ø 4 (Z3)	Ø 5	Ø 6	Ø 8	Ø 10	Ø 12	
P Non Alloyed	1	C35, Ck45, 1020, 1045, 1060, 28Mn6	125 HB	1.5xØ	0.5xØ	1.0xØ	0.024	0.030	0.040	0.055	0.065	0.077	
			190 HB										
			250 HB										
P Low Alloyed	2	42CrMo4, S150, Ck60, 4140, 4340, 100Cr6	180 HB	1.5xØ	0.5xØ	1.0xØ	0.025	0.030	0.039	0.053	0.063	0.074	
			230 HB										
			280 HB										
			350 HB										
P High Alloyed	3	X40CrMoV5, H13, M42, D3, S6-5-2, 12Ni19	220 HB	1.5xØ	0.5xØ	1.0xØ	0.021	0.026	0.033	0.046	0.055	0.064	
			280 HB										
			320 HB										
			350 HB										
M Austenitic	4	304, 316, X5CrNi18-9	180 HB	1.5xØ	0.5xØ	1.0xØ	0.017	0.022	0.028	0.038	0.045	0.053	
			240 HB										
			290 HB										
M Duplex	5	X2CrNiN23-4, S31500	290 HB	1.5xØ	0.5xØ	1.0xØ	0.013	0.017	0.021	0.029	0.035	0.040	
			310 HB										
M Ferritic & Martensitic	6	410, X6Cr17, 17-4PH, 430	200 HB	1.5xØ	0.5xØ	1.0xØ	0.013	0.017	0.021	0.029	0.035	0.040	
			42 HRC										
K Grey	7	GG20, GG40, EN-GJL-250, N030B	150 HB	1.5xØ	0.5xØ	1.0xØ	0.029	0.036	0.047	0.064	0.076	0.089	
			200 HB										
			250 HB										
K Malleable & Nodular	8	GGG40, GGG70, 50005	150 HB	1.5xØ	0.5xØ	1.0xØ	0.025	0.031	0.040	0.055	0.066	0.077	
			200 HB										
			250 HB										
S Fe, Ni & Co based	9	Incoloy 800, Inconel 700, Stellite 21	240 HB	1.5xØ	0.3xØ	1.0xØ	0.014	0.018	0.023	0.031	0.037	0.044	
			250 HB										
			350 HB										
S Ti based	10	T40, TiAl6V4	-	1.5xØ	0.5xØ	1.0xØ	0.015	0.018	0.023	0.032	0.038	0.045	
			-										
H Steel	11	X100CrMo13, 440C, G-X260NiCr42	45 HRC	1.5xØ	0.3xØ	0.2xØ	0.011	0.013	0.017	0.023	0.028	0.032	
			50 HRC										
			55 HRC										
H Chilled Cast Iron	12	Ni-Hard 2	400 HB	1.5xØ	0.2xØ	0.1xØ	0.008	0.010	0.013	0.017	0.021	0.024	
			55 HRC										
H White Cast Iron	13	G-X300CrMo15	55 HRC	1.5xØ	0.2xØ	0.1xØ	0.008	0.010	0.013	0.017	0.021	0.024	
NF Aluminium	14	AlSi12	130 HB	1.5xØ	0.5xØ	1.0xØ	0.027	0.033	0.042	0.058	0.069	0.081	

MACHINING CONDITIONS - SOLID END MILLS - DEPTH OF CUT AND FEED

HIGH FEED, 4 FLUTE – LT 4000 - Ø 3 - 6, 8, 10, 12

Material Group	Lamina Gr. N°	Material Examples	Hardness	Profiling		fz [mm/tooth]							
				ap	ae	Ø 3	Ø 4	Ø 5	Ø 6	Ø 8	Ø 10	Ø 12	
P	Non Alloyed	C35, Ck45, 1020, 1045, 1060, 28Mn6	125 HB	0.025xØ	0.5xØ	0.140	0.200	0.240	0.260	0.340	0.400	0.450	
			190 HB										
			250 HB										
	Low Alloyed	2	42CrMo4, St50, Ck60, 4140, 4340, 100C6	180 HB	0.025xØ	0.5xØ	0.132	0.188	0.226	0.244	0.320	0.376	0.423
				230 HB									
				280 HB									
				350 HB									
	High Alloyed	3	X40CrMoV5, H13, M42, D3, S6-5-2, 12Ni19	220 HB	0.025xØ	0.5xØ	0.111	0.158	0.190	0.205	0.269	0.316	0.356
				280 HB									
320 HB				0.084			0.120	0.144	0.156	0.204	0.240	0.270	
350 HB													
K	Grey	GG20, GG40, EN-GJL-250, N030B	150 HB	0.025xØ	0.5xØ	0.154	0.220	0.264	0.286	0.374	0.440	0.495	
			200 HB										
			250 HB										
	Malleable & Nodular	8	GG20, GG70, 50005	150 HB	0.025xØ	0.5xØ	0.133	0.190	0.228	0.247	0.323	0.380	0.428
				200 HB									
				250 HB									
H	Steel	X100 CrMo13, 440C, G-X260NiCr42	45 HRc	0.025xØ	0.5xØ	0.070	0.100	0.120	0.130	0.170	0.200	0.225	
			50 HRc										
			55 HRc		0.3xØ								0.056
	Chilled Cast Iron	12	Ni-Hard 2	400 HB	0.025xØ	0.3xØ	0.056	0.080	0.096	0.104	0.136	0.160	0.180
White Cast Iron	13	G-X300CrMo15	55 HRc	0.025xØ	0.3xØ	0.056	0.080	0.096	0.104	0.136	0.160	0.180	

MACHINING CONDITIONS

THREAD
TURNING

THREAD
MILLING

MACHINING CONDITIONS - THREAD TURNING - CUTTING SPEED (Vc)

LT 10

Material Group	Lamina Gr. N°	Material Examples	Hardness	Vc [m/min]	
				min	max
Non Alloyed P Low Alloyed High Alloyed	1	C35, Ck45, 1020, 1045, 1060, 28Mn6	125 HB	120	200
			190 HB	110	180
			250 HB	100	170
	2	42CrMo4, St50, Ck60, 4140, 4340, 100Cr6	180 HB	100	170
			230 HB		
			280 HB	70	120
			350 HB	60	90
	3	X40CrMoV5, H13, M42, D3, S6-5-2, 12Ni19	220 HB	100	170
			280 HB		
320 HB			70	120	
350 HB			60	90	
Austenitic	4	304, 316, X5CrNi18-9	180 HB	70	140
			240 HB	80	120
M Duplex	5	X2CrNiN23-4, S31500	290 HB	50	110
			310 HB		
Ferritic & Martensitic	6	410, X6Cr17, 17-4PH, 430	200 HB	70	140
			42 HRc	50	110
Grey	7	GG20, GG40, EN-GJL-250, N030B	150 HB	70	150
			200 HB	100	140
			250 HB	70	120
K Malleable & Nodular	8	GGG40, GGG70, 50005	150 HB	70	150
			200 HB	100	140
			250 HB	70	120
S Fe, Ni & Co based	9	Incoloy 800	240 HB	40	60
		Inconel 700	250 HB	30	50
		Stellite 21	350 HB	20	40
TI based	10	T40	-	50	70
		TiAl6V4	-	40	60
H Steel Chilled Cast Iron White Cast Iron	11	X100 CrMo13, 440C, G-X260NiCr42	45 HRc	30	50
			50 HRc		
			55 HRc		
		Ni-Hard 2	400 HB		40
G-X300CrMo15	55 HRc				
NF Aluminium	12	AlSi12	130 HB	100	400

RECOMMENDED NUMBER OF PASSES

ISO METRIC - EXTERNAL

No. OF PASSES	PITCH (MM)										
	4	3.5	3	2.5	2	1.75	1.5	1.25	1	0.75	0.5
1	0.34	0.34	0.27	0.26	0.24	0.23	0.23	0.20	0.19	0.17	0.11
2	0.30	0.31	0.23	0.22	0.23	0.21	0.21	0.18	0.16	0.15	0.09
3	0.25	0.24	0.20	0.20	0.19	0.16	0.18	0.14	0.13	0.11	0.08
4	0.21	0.20	0.18	0.17	0.17	0.14	0.16	0.12	0.10	0.06	0.06
5	0.19	0.19	0.17	0.16	0.15	0.12	0.11	0.10	0.06		
6	0.18	0.17	0.16	0.14	0.12	0.10	0.06	0.06			
7	0.16	0.16	0.15	0.13	0.10	0.08					
8	0.15	0.15	0.13	0.12	0.06	0.06					
9	0.15	0.14	0.12	0.10							
10	0.14	0.12	0.11	0.06							
11	0.13	0.10	0.09								
12	0.12	0.06	0.06								
13	0.10										
14	0.06										
Total	2.48	2.18	1.87	1.56	1.26	1.10	0.95	0.80	0.64	0.49	0.34

DEPTH OF CUT

ISO METRIC - INTERNAL

No. OF PASSES	PITCH (MM)										
	4	3.5	3	2.5	2	1.75	1.5	1.25	1	0.75	0.5
1	0.32	0.32	0.25	0.25	0.23	0.22	0.22	0.19	0.18	0.16	0.10
2	0.27	0.29	0.22	0.21	0.21	0.20	0.20	0.16	0.15	0.14	0.09
3	0.22	0.23	0.19	0.19	0.18	0.15	0.17	0.13	0.12	0.10	0.07
4	0.20	0.19	0.17	0.16	0.16	0.13	0.15	0.11	0.10	0.06	0.06
5	0.19	0.18	0.16	0.15	0.14	0.11	0.10	0.10	0.06		
6	0.18	0.16	0.16	0.13	0.11	0.09	0.06	0.06			
7	0.16	0.15	0.14	0.12	0.09	0.08					
8	0.15	0.14	0.12	0.11	0.06	0.06					
9	0.14	0.13	0.11	0.09							
10	0.14	0.11	0.10	0.06							
11	0.12	0.09	0.08								
12	0.10	0.06	0.06								
13	0.09										
14	0.06										
Total	2.34	2.05	1.76	1.47	1.18	1.04	0.90	0.75	0.61	0.46	0.32

DEPTH OF CUT

MACHINING CONDITIONS - THREAD TURNING

RECOMMENDED NUMBER OF PASSES

No. OF PASSES	UN EXTERNAL (TPI)			UN INTERNAL (TPI)			WHITWORTH EXTERNAL & INTERNAL (TPI)			BSPT EXTERNAL & INTERNAL (TPI)		
	20	16	12	20	16	12	19	14	11	19	14	11
1	0.20	0.22	0.25	0.19	0.21	0.24	0.22	0.24	0.26	0.19	0.19	0.22
2	0.16	0.20	0.23	0.16	0.19	0.21	0.19	0.21	0.23	0.18	0.18	0.21
3	0.15	0.18	0.20	0.14	0.17	0.19	0.17	0.17	0.20	0.17	0.17	0.20
4	0.13	0.14	0.18	0.11	0.13	0.17	0.14	0.15	0.18	0.15	0.16	0.19
5	0.11	0.11	0.16	0.10	0.10	0.15	0.11	0.14	0.17	0.13	0.15	0.18
6	0.06	0.09	0.14	0.06	0.09	0.13	0.06	0.12	0.16	0.08	0.15	0.16
7		0.06	0.11		0.06	0.10		0.10	0.13		0.12	0.15
8			0.06			0.06		0.06	0.12		0.08	0.13
9									0.06			0.08
Total	0.81	1.00	1.33	0.76	0.95	1.25	0.89	1.19	1.51	0.90	1.20	1.51

DEPTH OF CUT

No. OF PASSES	NPT EXTERNAL & INTERNAL (TPI)				TRAPEZOIDAL EXTERNAL & INTERNAL (MM)	
	18	14	11.5	8	4.0	3.00
1	0.18	0.22	0.23	0.32	0.24	0.20
2	0.15	0.18	0.19	0.25	0.23	0.19
3	0.13	0.15	0.17	0.21	0.22	0.18
4	0.13	0.14	0.16	0.17	0.22	0.18
5	0.12	0.13	0.15	0.16	0.21	0.17
6	0.11	0.12	0.13	0.16	0.20	0.17
7	0.09	0.10	0.12	0.15	0.19	0.16
8	0.08	0.10	0.10	0.15	0.18	0.15
9	0.06	0.09	0.10	0.14	0.17	0.14
10		0.08	0.10	0.13	0.16	0.13
11		0.06	0.09	0.13	0.14	0.11
12			0.08	0.12	0.13	0.08
13			0.06	0.12	0.08	
14				0.10		
15				0.08		
16				0.06		
Total	1.05	1.37	1.68	2.45	2.37	1.86

DEPTH OF CUT

MACHINING CONDITIONS - THREAD MILLING - CUTTING SPEED (Vc)

Material Group	Lamina Gr. N°	Material Examples	Hardness	V _c [m/min]	
				min	max
P Non Alloyed Low Alloyed High Alloyed	1	C35, Ck45, 1020, 1045, 1060, 28Mn6	125 HB	80	130
			190 HB	70	110
			250 HB	60	100
	2	42CrMo4, St50, Ck60, 4140, 4340, 100Cr6	180 HB	70	110
			230 HB		
			280 HB	60	100
			350 HB	50	80
	3	X40CrMoV5, H13, M42, D3, S6-5-2, 12Ni19	220 HB	70	110
			280 HB	60	100
320 HB			50	80	
350 HB				70	
M Austenitic Duplex Ferritic & Martensitic	4	304, 316, X5CrNi18-9	180 HB	70	110
			240 HB	60	90
	5	X2CrNiN23-4, S31500	290 HB	60	80
			310 HB		
6	410, X6Cr17, 17-4PH, 430	200 HB	70	90	
		42 HRC	60	80	
K Grey Malleable & Nodular	7	GG20, GG40, EN- GJL-250, N030B	150 HB	60	110
			200 HB	70	110
			250 HB	60	90
	8	GGG40, GGG70, 50005	150 HB	60	110
			200 HB		90
			250 HB		90
S Fe, Ni & Co based Ti based	9	Incoloy 800	240 HB	40	60
		Inconel 700	250 HB	30	50
		Stellite 21	350 HB	20	40
	10	T40	-	40	70
		TiAl6V4	-	25	50
H Steel Chilled Cast Iron White Cast Iron	11	X100 CrMo13, 440C, G-X260NiCr42	45 HRc	30	50
			50 HRc		
			55 HRc		
		Ni-Hard 2	400 HB	25	40
G-X300CrMo15	55 HRc				
NF Aluminium	12	AISI12	130 HB	80	300

MACHINING CONDITIONS - THREAD MILLING

RECOMMENDED TOOL FEED

Material Group	Lamina Gr. N°	Material Examples	Hardness	Feed (mm/tooth)					
				1.5 - 3.0	3.0 - 5.0	5.0 - 7.0	7.0 - 9.0	9.0 - 11.0	
P	Non Alloyed	C35, Ck45, 1020, 1045, 1060, 28Mn6	125 HB	0.03	0.04	0.06	0.07	0.09	
			190 HB	0.02	0.03	0.05	0.06	0.07	
			250 HB						
	Low Alloyed	2	42CrMo4, St50, Ck60, 4140, 4340, 100Cr6	180 HB	0.02	0.03	0.05	0.06	0.07
				230 HB					
				280 HB				0.05	0.05
				350 HB					
	High Alloyed	3	X40CrMoV5, H13, M42, D3, S6-5-2, 12Ni19	220 HB	0.02	0.03	0.05	0.06	0.07
				280 HB					
				320 HB				0.05	0.05
				350 HB					
	M	Austenitic	4	304, 316, X5CrNi18-9	180 HB	0.02	0.02	0.03	0.04
240 HB					0.02			0.06	
Duplex		5	X2CrNiN23-4, S31500	290 HB	0.02	0.02	0.02	0.03	0.04
				310 HB					
Ferritic & Martensitic		6	410, X6Cr17, 17-4PH, 430	200 HB	0.02	0.02	0.02	0.03	0.03
				42 HRc					
K	Grey	7	GG20, GG40, EN-GJL-250, N030B	150 HB	0.02	0.03	0.06	0.07	
				200 HB			0.05	0.06	
				250 HB					
	Malleable & Nodular	8	GGG40, GGG70, 50005	150 HB	0.02	0.03	0.06	0.07	
				200 HB			0.05	0.06	
				250 HB					
S	Fe, Ni & Co based	9	Incoloy 800	240 HB	0.02	0.02	0.02	0.03	
			Inconel 700	250 HB	0.015	0.015	0.015	0.02	
			Stellite 21	350 HB	0.01	0.01	0.01	0.015	
	Ti based	10	TiAl6V4	-	0.02	0.02	0.02	0.02	0.025
			T40	-					0.02
	H	Steel	11	X100 CrMo13, 440C, G-X260NiCr42	45 HRc	0.01	0.01	0.02	0.02
50 HRc									
55 HRc									
400 HB									
Chilled Cast Iron	White Cast Iron	11	Ni-Hard 2	400 HB	0.01	0.01	0.02	0.02	
				G-X300CrMo15					55 HRc
NF	Aluminium	12	AlSi12	130 HB	0.03	0.03	0.04	0.08	

MACHINING CONDITIONS

DRILLING

MACHINING CONDITIONS - DRILLING - CUTTING SPEED (Vc)

LT 30

Material Group	Lamina Gr. N°	Material Examples	Hardness	V _c [m/min]	
				min	max
P Non Alloyed Low Alloyed High Alloyed	1	C35, Ck45, 1020, 1045, 1060, 28Mn6	125 HB	180	270
			190 HB		230
			250 HB		200
	2	42CrMo4, St50, Ck60, 4140, 4340, 100Cr6	180 HB	120	230
			230 HB		190
			280 HB	100	170
					350 HB
	3	X40CrMoV5, H13, M42, D3, S6-5-2, 12Ni19	220 HB	70	170
			280 HB		150
320 HB			60	130	
				350 HB	100
M Austenitic Duplex Ferritic & Martensitic	4	304, 316, X5CrNi18-9	180 HB	170	230
			240 HB	120	210
	5	X2CrNiN23-4, S31500	290 HB	70	120
			310 HB		120
	6	410, X6Cr17, 17-4PH, 430	200 HB	100	150
			42 HRc	60	100
K Grey Malleable & Nodular	7	GG20, GG40, EN- GJL-250, N030B	150 HB	150	230
			200 HB		210
			250 HB		170
	8	GGG40, GGG70, 50005	150 HB	120	200
			200 HB		170
			250 HB		150
S Fe, Ni & Co based Ti based	9	Incoloy 800	30	40	
		Inconel 700			
		Stellite 21			
	10	T40	40	60	
		TiAl6V4	30	40	
H Steel Chilled Cast Iron White Cast Iron	11	X100CrMo13, 440C, G-X260NiCr42	45 HRc	50	90
			50 HRc	40	70
			55 HRc	30	60
		Ni-Hard 2	40	60	
		G-X300CrMo15	30	50	
NF Aluminium	12	AlSi12	130 HB	200	400

MACHINING CONDITIONS - DRILLING - DEPTH OF CUT AND FEED

SPMG 050204 NN
 SPMG 060204 NN
 SPMG 07T08 NN

SPMG 090408 NN
 SPMG 110408 NN

Material Group	Lamina Gr. N°	Material Examples	Hardness	SPMG 050204 NN		SPMG 060204 NN		SPMG 07T308 NN		SPMG 090408 NN		SPMG 110408 NN		
				Feed [mm/z] min	Feed [mm/z] max	Feed [mm/z] min	Feed [mm/z] max	Feed [mm/z] min	Feed [mm/z] max	Feed [mm/z] min	Feed [mm/z] max	Feed [mm/z] min	Feed [mm/z] max	
P Non Alloyed Low Alloyed High Alloyed	1	C35, Ck45, 1020, 1045, 1060, 28Mn6	125 HB	0.04	0.09	0.04	0.09	0.06	0.11	0.06	0.11	0.08	0.14	
			190 HB											
			250 HB											
	2	42CrMo4, S150, Ck60, 4140, 4340, 100Cr6	180 HB	0.04	0.09	0.04	0.09	0.06	0.11	0.06	0.11	0.07	0.14	
			230 HB											
			280 HB											
			350 HB											
	3	X40CrMoV5, H13, M42, D3, S6-5-2, 12Ni19	220 HB	0.05	0.09	0.05	0.09	0.09	0.11	0.09	0.11	0.07	0.12	
			280 HB											
320 HB			0.08	0.08	0.10	0.10	0.11	0.11						
350 HB														
M Austenitic Duplex Ferritic & Martensitic	4	304, 316, X5CrNi18-9	180 HB	0.04	0.09	0.04	0.09	0.06	0.11	0.06	0.11	0.06	0.11	
			240 HB											
	5	X2CrNiN23-4, S31500	290 HB	0.05	0.08	0.05	0.08	0.09	0.10	0.09	0.10	0.06	0.10	
			310 HB											
	6	410, X6Cr17, 17-4PH, 430	200 HB	0.05	0.08	0.05	0.08	0.09	0.10	0.09	0.10	0.09	0.09	0.10
			42 HRc											
K Grey Malleable & Nodular	7	GG20, GG40, EN-GJL-250, N030B	150 HB	0.07	0.09	0.07	0.10	0.10	0.12	0.10	0.12	0.10	0.15	
			200 HB											
			250 HB											
	8	GGG40, GGG70, 50005	150 HB	0.07	0.09	0.07	0.10	0.10	0.12	0.10	0.12	0.10	0.14	
			200 HB											
			250 HB											
S Fe, Ni & Co based	9	Incoloy 800	0.04	0.07	0.04	0.07	0.06	0.09	0.06	0.09	0.06	0.10		
		Inconel 700												
		Stellite 21												
Ti based	10	TiAl6V4	0.04	0.07	0.04	0.07	0.06	0.09	0.06	0.09	0.06	0.09		
		T40												
H Steel Chilled Cast Iron White Cast Iron	11	X100 CrMo13, 440C, G-X260NiCr42	45 HRc	0.04	0.07	0.04	0.07	0.06	0.09	0.06	0.09	0.06	0.09	
			50 HRc											
			55 HRc											
		Ni-Hard 2												
		G-X300CrMo15	55 HRc											
NF Aluminium	12	AlSi12	130 HB	0.04	0.09	0.04	0.09	0.06	0.11	0.06	0.11	0.06	0.11	

MACHINING CONDITIONS - DRILLING - DEPTH OF CUT AND FEED

WCMX 040208 NN
WCMX 050308 NN

WCMX 06T308 NN
WCMX 080412 NN

Material Group	Lamina Gr. N°	Material Examples	Hardness	WCMX 040208 NN		WCMX 050308 NN		WCMX 06T308 NN		WCMX 080412 NN		
				Feed [mm/z] min	Feed [mm/z] max	Feed [mm/z] min	Feed [mm/z] max	Feed [mm/z] min	Feed [mm/z] max	Feed [mm/z] min	Feed [mm/z] max	
P Non Alloyed Low Alloyed High Alloyed	1	C35, Ck45, 1020, 1045, 1060, 28Mn6	125 HB	0.05	0.10	0.06	0.11	0.06	0.12	0.06	0.16	
			190 HB									
			250 HB									
	2	42CrMo4, St50, Ck60, 4140, 4340, 100Cr6	180 HB	0.05	0.10	0.06	0.11	0.06	0.12	0.06	0.06	0.16
			230 HB									
			280 HB									
			350 HB									0.15
	3	X40CrMoV5, H13, M42, D3, S6-5-2, 12Ni19	220 HB	0.07	0.10	0.09	0.11	0.08	0.12	0.09	0.09	0.16
			280 HB									
320 HB			0.07	0.09	0.09	0.10	0.08	0.11	0.09	0.14		
350 HB												
M Austenitic Duplex Ferritic & Martensitic	4	304, 316, X5CrNi18-9	180 HB	0.05	0.10	0.06	0.11	0.06	0.12	0.06	0.15	
			240 HB									
	5	X2CrNiN23-4, S31500	290 HB	0.07	0.09	0.09	0.10	0.08	0.11	0.09	0.14	
			310 HB									
	6	410, X6Cr17, 17-4PH, 430	200 HB	0.07	0.09	0.09	0.10	0.08	0.11	0.09	0.09	0.14
			42 HRc									
K Grey Malleable & Nodular	7	GG20, GG40, EN-GJL-250, N030B	150 HB	0.09	0.11	0.09	0.12	0.09	0.13	0.10	0.18	
			200 HB									
			250 HB									
	8	GGG40, GGG70, 50005	150 HB	0.09	0.11	0.09	0.12	0.09	0.13	0.10	0.18	
			200 HB									
			250 HB									
S Fe, Ni & Co based Ti based	9	Incoloy 800	0.05	0.08	0.06	0.09	0.06	0.10	0.06	0.10	0.13	
		Inconel 700										
		Stellite 21										
	10	TiAl6V4	0.05	0.08	0.06	0.09	0.06	0.10	0.06	0.10	0.06	0.13
		T40										
	H Steel Chilled Cast Iron White Cast Iron	11	X100 CrMo13, 440C, G-X260NiCr42	45 HRc	0.05	0.08	0.06	0.09	0.06	0.10	0.06	0.13
50 HRc												
55 HRc												
400 HB												
55 HRc												
NF Aluminium	12	AlSi12	130 HB	0.05	0.10	0.06	0.11	0.10	0.12	0.10	0.16	

TECHNICAL GUIDE

MACHINING OPTIMIZATION

For new users of Lamina Technologies Multi-Mat™ (multi-material) inserts and to get more productivity and longer tool life, we have prepared a short machining guide to insure your satisfaction with our products.

The machining conditions included after each insert are our guidelines for optimal machining. However, our inserts can work in a range of cutting conditions to meet special machining needs.



TURNING



Check the condition of the tool holder (insert seat, shim, lever, screw) and check if the insert is well seated and clamped.



If there are interrupted cut or passes with short lengths of cut, dry operation is recommended to avoid thermal shocks. For heavy interrupted cut feed rate should be reduced.



Check the stability of the machine. The tool overhang should be as short as possible.

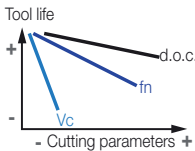

Cutting speed has the greatest influence on tool life. For high productivity and long tool life, first increase d.o.c. and feed rate.

$$\text{Feed} \times \text{d.o.c.} = \text{Amax}$$

Respect maximum chip section area for each insert. $A_{max} = \text{feed} \times \text{d.o.c.}$

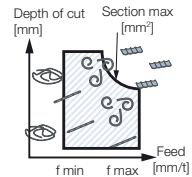

For higher productivity and better chip control in roughing, work close to the recommended A_{max} value.

MILLING



Check the condition of the tool holder (insert seat, shim, lever, screw) and check if the insert is well seated and clamped.



Check the stability of the machine. The tool overhang should be as short as possible.

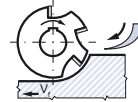

Climb Milling

Usually this is the recommended direction. Tool life up to 40% longer than conventional.

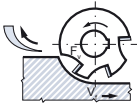

Conventional Milling

Recommended only for:

- Old machines with backlash in the table transmission
- Flame cut, forged and cast workpieces
- Thin workpieces (in order to reduce vibration)

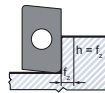

K = 90° Approach angle
High radial forces / Low axial forces.

Recommended:

- When 90° wall is needed
- For slender workpieces

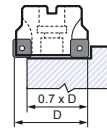

For face milling the width of cut (ae) should be about 70% of the cutter diameter, in order to achieve better chip formation and longer tool life. For limited engagement conditions, it is necessary to increase feed per tooth.

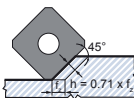

K = 45° Approach angle
identical radial and axial forces.
High productivity $fz=1.41 \times h$

Recommended:

- When overhang is long (lower vibration tendency)
- For face milling (1st choice)



Round Inserts:
Roughing and general purposes.
Strongest cutting edge.

MACHINING OPTIMIZATION

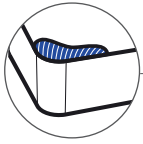

BUILT-UP EDGE
(Adhesive Wear)

Description

The workpiece material is welded to the cutting edge. Normally caused by low temperatures

Solutions

Increase cutting speed / Increase feed / Use more positive geometry

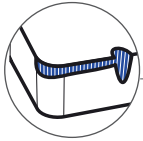

NOTCH WEAR
(Adhesive/Mechanic Wear)

Description

Result of adhesive or mechanical action. Chipping or localized wear at the depth of cut line.

Solutions

Use more positive geometry / Reduce feed / Vary depth of cut

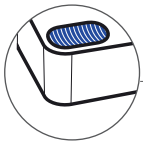

CRATER
(Chemical Wear)

Description

Happens on the rake surface. Normally the result of a combination of a diffusion and abrasion wear mechanism.

Solutions

Decrease cutting speed / Check coolant direction / Use more positive geometry

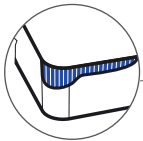

FLANK WEAR
(Abrasive Wear)

Description

Abrasive wear mechanism that happens on the cutting edge's flank. Not common in Lamina inserts.

Solutions

Decrease cutting speed / Check coolant direction.



PLASTIC DEFORMATION
(Thermal Wear)

Description

Caused by cutting forces and too high temperature. Not common in Lamina inserts.

Solutions

Decrease cutting speed / Decrease feed rate

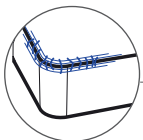

THERMAL CRACKS
(Thermal Wear)

Description

Small cracks normally at 90° to the cutting edge caused by temperature variation.

Solutions

Stabilize the temperature / Shut off the coolant

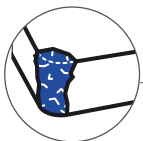

BREAKAGE
(Mechanic Wear)

Description

Most breakages happen because the wear development is not seen in time.

Solutions

Check the tool holder / Check the tool overhang / Check the Amax / Decrease feed and Vc / Apply more robust insert / Check the run-out

MATERIAL GROUPS

MATERIAL GROUP	LAMINA GR. N°	VDI GRP	MATERIAL EXAMPLES	DESCRIPTION	CAUTION	
Non Alloyed P Low Alloyed High Alloyed	1	1	C35, Ck45, 1020, 1045, 1060, 28Mn6	Non-alloyed Steel Composition: Fe-C alloy (usually 0.1 to 0.6% carbon). Characteristics: Good machinability and high cutting speeds can be applied. When it has less than 0.25% carbon, it can be very sticky, requiring positive rake and small land inserts.	Built-up edge Crater	
		2				
		3				
	2	4, 6	42CrMo4, S150, Ck60, 4140, 4340, 100Cr6		Alloyed Steel Composition: Fe-C alloy (maximum 2.1% carbon) with additives like Cr, Mo, V, Ni, Mn, Co, W, etc. Characteristics: The variation in the amount of alloying elements and different heat treatments control features such as mechanical resistance and machinability. It's important to follow the cutting speeds recommended according to the hardness of the steel, as it influences temperature as well as chemical and adhesive wears.	Built-up edge Crater
		5, 7				
		6				
		8				
	3	10	X40CrMoV5, H13, M42, D3, S6-5-2, 12Ni19		High alloyed Steel have more than 5% alloying elements.	Crater
		10				
11						
Austenitic M Duplex Ferritic & Martensitic	4	14	304, 316, X5CrNi18-9	Composition: Alloyed steel, more than 11% chrome (Cr). Characteristics: Stainless steels do not stain, corrode, or rust as easily as ordinary steel. Usually they are difficult to machine because of its narrow range of cutting speeds. If the cutting speed is too low, the material sticks in the cutting edge, if it's too high, the high quantity of additives produces abrasive wears in the cutting edge.	Built-up edge Notch wear	
		14				
	5	14	X2CrNiN23-4, S31500		Notch wear Crater	
		14				
	6	12	410, X6Cr17, 17-4PH, 430		Crater	
		13				
Grey K Malleable & Nodular	7	15	GG20, GG40, EN-GJL-250, N030B	Composition: Fe-C alloy with 2.1 to 5% of carbon. It can be alloyed with Si, P, Mn and Ni. Characteristics: Grey cast iron tends to be brittle, and malleable cast irons usually have a more ductile but less homogeneous micro-structure. Reinforced cutting edges will perform best. High productivity can be achieved by using high feeds.	Flank wear Crater Mechanical cracks	
		15				
		16				
	8	17, 19	GG40, GG70, 50005			
		17, 19				
		18, 20				
Fe, Ni & Co based S Ti based	9	31, 32	Incoloy 800	Composition: Iron (Fe) based, Nickel (Ni) based or Cobalt (Co) based alloys and Titanium alloys. Characteristics: High temperature alloys and titanium provide excellent mechanical strength resistance, as well as corrosion and oxidation resistance. Relatively low cutting speed is recommended due to their poor thermal conductivity.	Notch wear Crater	
		33				
		34				
	10	36	TiAl6V4 T40			
		37				
		37				
Steel H Chilled Cast Iron White Cast Iron	11	38	X100 CrMo13, 440C, G-X260NiCr42	This group includes hardened and tempered steel up to 55 HRC, chilled and white cast iron up to 55 HRC. Machining success depends largely on clamping system rigidity, as cutting forces and power consumption are high. Finishing represents the majority of the operations for this material group.	Crater	
		38				
		38				
	12	40	Ni-Hard 2			
13	41	G-X300CrMo15				
Alu AL (<8%Si) NF Copper Alloys Non Metallic	14	25	AlSi12	Non-ferrous and soft materials (less than 130HB of hardness). Most common: Aluminium Composition: Al alloys can be alloyed with Cu, Zn, Mg, Mn and Si.	Built-up edge	
		25				
	15	21, 22, 23, 24	4% < Si < 8% Si < 4%			
		26, 27, 28	CuZn30			
	17	29	Fiber Plastics			
		-	Graphite			
30		Hard Rubber				

MACHINING RECOMMENDATIONS



In machining stainless steel, please verify and respect the cutting speed recommended for the insert as there is a tendency to machine at speeds that are too low.



In machining stainless steel or exotic materials, P geometry inserts (CNMP, TNMP, WNMP) and NX chipbreakers are recommended as first choice.



In machining exotic materials, it is important to verify cutting conditions of the specific insert.

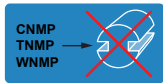

P geometry inserts (CNMP, TNMP, WNMP) are not recommended when machining with interrupted cut.

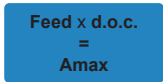

It is important to verify and respect A_{max} , which is the maximum chip section. Feed x d.o.c. must be lower than the number noted as A_{max} .

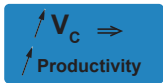

To increase machining productivity, it is recommended to increase speed (V_c) while respecting chip size calculation.

COOLANT GUIDE

SUCCESSFUL MACHINING OPERATIONS DEPEND ON CORRECT COOLANT APPLICATION

TURNING

- In continuous cut, the application of coolant is recommended for all workpiece materials.
- If there is interrupted cut, use dry operation when machining material groups P, M, K and H.
- Coolant is always recommended for High-Temp Alloys (Group S) and Aluminum (Group N).

MILLING

- In dry operations, the usage of “air blow” is always recommended in order to evacuate the chips which can accumulate causing tool breakage and problems with surface finishing.

DRILLING

- Coolant in drilling is always recommended independent of workpiece material as it helps chip evacuation, improves hole quality and increases tool life.

MATERIAL GROUP	TURNING		MILLING	DRILLING
	STABLE CUT	INTERRUPTED CUT		
P				
M				
K				
S				
H				
N				

- When machining Duplex Stainless Steels, both wet and dry operations should be considered, depending on variables in the machining process.

TECHNICAL FORMULAS

Turning

Cutting Speed (m/min)	$V_c = \frac{D_m \times \pi \times n}{1000}$
Rotation (Rev/min)	$n = \frac{V_c \times 1000}{D_m \times \pi}$
Chip Removal Rate (cm³/min)	$Q = V_c \times a_p \times f_n$
Cutting Time (min)	$T_c = \frac{l_m}{f_n \times n}$
Surface Roughness (μm)	$R_{max} = \frac{f_n^2}{r_\epsilon} \times 125$

Symbol	Designation	Unit
D_m	Machining diameter	mm
f_n	Feed per revolution	mm/rev
l_m	Machining length	mm
n	Rotation	rev/min
Q	Chip removal rate	cm ³ /min
A_{max}	d.o.c x feed	mm ²
r_ε	Nose radius	mm
T_c	Cutting time	min
R_{max}	Surface roughness	μm

Milling

Cutting Speed (m/min)	$V_c = \frac{n \times \pi \times D}{1000}$
Rotation (Rev/min)	$n = \frac{V_c \times 1000}{\pi \times D}$
Table Feed (mm/min)	$V_f = n \times z_c \times f_z$
Cutting Output (cm³/min)	$Q = \frac{a_e \times a_p \times V_f}{1000}$
Feed per Tooth	$f_z = \frac{V_f}{n \times z_c}$

Symbol	Designation	Unit
V_c	Cutting speed	m/min
a_p	Depth of cut (d.o.c.)	mm
a_e	Radial depth of cut (width of cut)	mm
D	Cutter diameter	mm
f_z	Feed per tooth	mm/tooth
Z_c	Effective number of teeth	pcs
V_f	Table Feed	mm/min
Z_n	Total number of teeth	pcs

COPY MILLING

EFFECTIVE DIAMETER FOR RPM CALCULATION

When calculating revolution per minute (n), the effective diameter must be taken into account. Refer to the formula below.

$$n = \frac{V_c \times 1000}{D_{\text{eff}} \times \pi}$$

$$D_{\text{eff}} = D1 + \ell$$

Symbol	Designation	Unit
D	Milling Cutter Diameter	mm
D_{eff}	Depth of cut (d.o.c.)	mm
D1	Cutter flat surface	mm
DOC	Depth of cut	mm
iC	Insert Diameter - Inscribed circle	mm
V_c	Cutting Speed	m/min
n	Rotation	rev/min
<i>ℓ</i>	Diameter compensation	mm

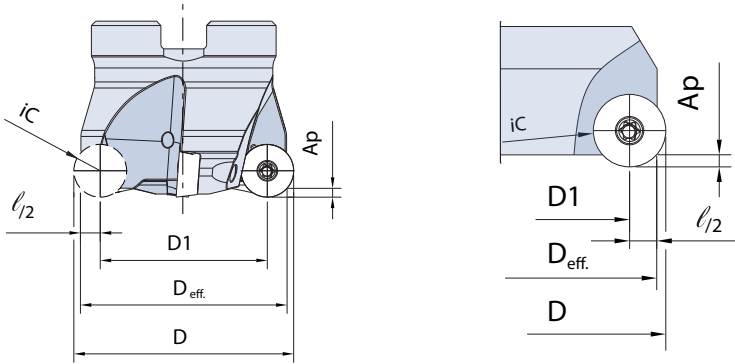

ℓ VALUES FOR DOC VALUES*

iC	DOC (Ap)							
	0.5	1.0	1.5	2.0	2.5	3.0	3.5	4.0
6	3.3	4.5	5.2	-	-	-	-	-
7	3.6	4.9	5.7	6.3	-	-	-	-
8	3.9	5.3	6.2	6.9	-	-	-	-
10	4.4	6.0	7.1	8.0	8.7	-	-	-
12	4.8	6.6	7.9	8.9	9.7	10.4	-	-
16	5.6	7.7	9.3	10.6	11.6	12.5	13.2	13.9

* For min/max depth of cut, please check the cutting parameter pages for each insert.

HIGH FEED MILLING

EFFECTIVE DIAMETER FOR RPM CALCULATION

The effective cutting diameter (D_{eff}) must be calculated to obtain the correct revolution per minute (RPM) and consequently the table feed.

The effective cutting diameter is calculated using the following values and formula.

$$n = \frac{V_c \times 1000}{D_{\text{eff}} \times \pi}$$

$$D_{\text{eff}} = D - \ell$$

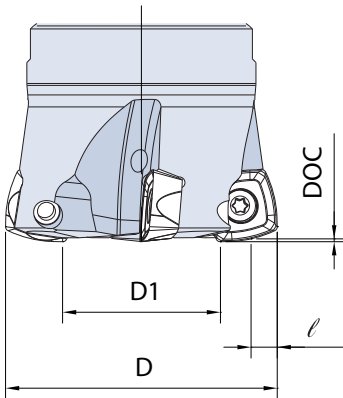

Symbol	Designation	Unit
D	Cutter Diameter	mm
DOC	Depth of cut	mm
ℓ	Diameter compensation (see chart below)	mm

SDKX 0904-HF SDKW 0904-HF	
DOC (mm)	ℓ (mm)
1.5	0
1.4	0.22
1.3	0.58
1.2	1.04
1.1	1.52
1.0	2.02
0.9	2.54
0.8	3.10
0.7	3.70
0.6	4.34
0.5	5.06
0.4	5.82
0.3	6.72
0.2	7.74
0.1	9.06

SDKX 1205-HF SDKW 1205-HF	
DOC (mm)	ℓ (mm)
2.0	0
1.8	0.66
1.6	1.58
1.4	2.58
1.2	3.66
1.0	4.84
0.8	6.16
0.6	7.66
0.4	9.44
0.2	11.76

APKT 0602-HF APKW 0602-HF	
DOC (mm)	ℓ (mm)
0.5	0
0.4	0.32
0.3	0.72
0.2	1.28
0.1	2.22

EXAMPLE FOR D_{eff} CALCULATION

Cutter: LT 903 S-W-D040/4 (D=40/Z=4)
 Insert: SDKX 1205-HF
 Material: Lamina Group 3 – 280 HB

VALUES	INCORRECT CALCULATION	CORRECT CALCULATION
$V_c = 120 \text{ m/min}$ $D = 40 \text{ mm}$ $\text{DOC} = 1.0 \text{ mm}$ $\ell = 4.84 \text{ mm}$ $D_{\text{eff}} = D - \ell$ $D_{\text{eff}} = 40 - 4.84$ $D_{\text{eff}} = 35.16$	$\text{RPM for } D=40$ $n = 954 \text{ rev/min}$	$\text{RPM for } D_{\text{eff}}=35.16$ $n = 1085 \text{ rev/min}$

LT 752 - MULTI-FUNCTION CUTTER LINE

APPLICATION PARAMETERS

SHOULDER MILLING - APKT 060204-PDTR

D	α° max. for linear ramping	Ap max. for linear ramping	Ae max. for linear plunging	Helical Milling			
				C min.	P max.	C max.	P max.
10	3	5.2	0.6	14	0.9	19	3.0
12	2.2			18		23	2.5
16	1.5			26		31	2.0
20	1.15			34		39	1.8
25	0.9			44		49	1.7
32	0.7			58		63	1.7

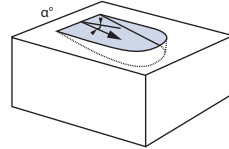

HIGH FEED MILLING - APKT & APKW 0602-HF

D	D1*	α° max. for linear ramping	Ap max. for linear ramping	Ae max. for linear plunging	Helical Milling			
					C min.	P max.	C max.	P max.
10	4.7	1.25	0.5	2.4	14.7	0.5	18	0.5
12	6.7	2.5			18.7		22	
16	10.7	2			26.7		30	
20	14.7	1.25			34.7		38	
25	19.7	1			44.7		48	
32	26.7	0.9			58.7		62	

* Flat surface on face milling = D1

PROGRAMMING RADIUS

Uncut Area = Uncut thickness, maximum mismatch between programmed corner radii (Rprog) and generated machined profile.

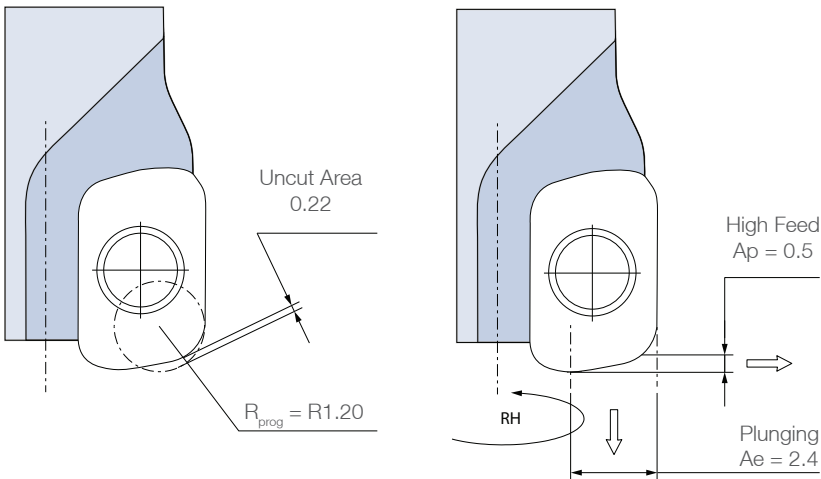

TECHNICAL INFORMATION

HELICAL INTERPOLATION

DRILLING - IRREGULAR WORK SURFACES

The example below shows a hole-making operation in a workpiece with irregular surface and weak set-up.

When using a drill body, until the full engagement is achieved, the operation is unbalanced causing vibrations, demanding a large feed rate reduction, with high risk of insert breakage. It can reduce the productivity in some cases.

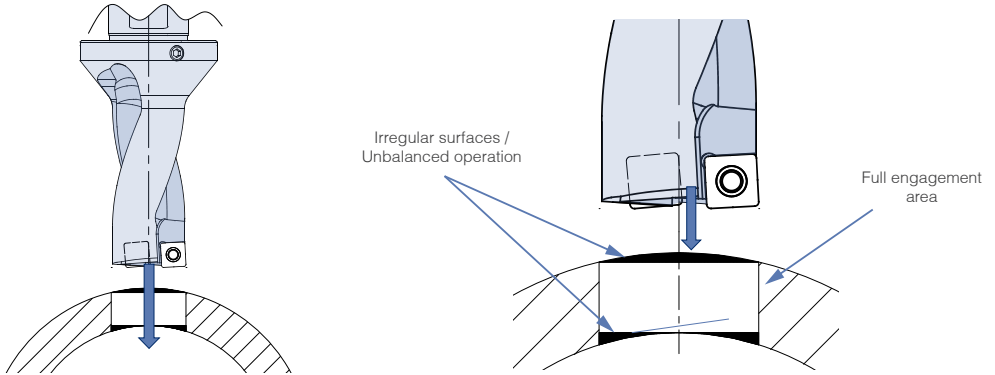

HELICAL MILLING - IRREGULAR WORK SURFACES

In this case, the helical milling machine strategy is the best option because it has:

1. Good chip control and evacuation
2. Better surface quality and dimensional tolerances
3. Lower power consumption and vibration tendencies = more machining stability

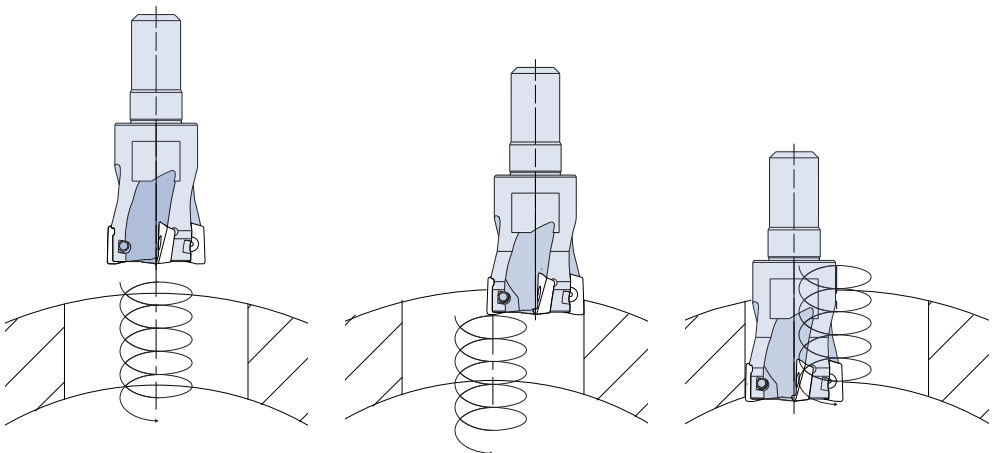

HELICAL MILLING - CUTTING DIRECTION

To maximize performance, the Helical Milling strategy must be applied with the correct cutting direction. For holemaking operations such as drilling and boring, CCLW is recommended for climb milling to keep the chip formation from thick to thin.

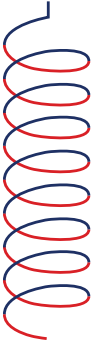

Counterclockwise direction (CCLW)

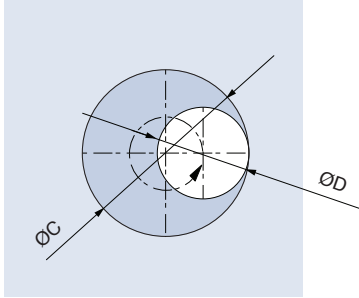

D = Milling Cutter Diameter
C = Hole Diameter

HELICAL MILLING - FEED RATE COMPENSATION

For Helical Milling, we need to compensate the feed rate, to keep the chip thickness like the same when performing a Linear Milling operation.

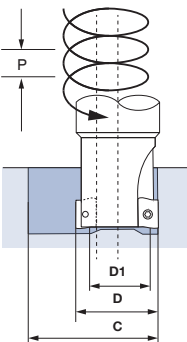

D = 16
C = 30

LINEAR MILLING

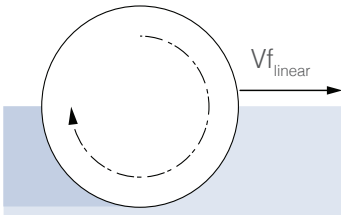

$$Vf_{linear} = fz \times RPM \times Z$$

RPM = 3600 rev/min
fz = 0.05 mm/tooth
Z = 4
Vf_{linear} = 720 mm/min
Climb Milling

CIRCULAR MILLING

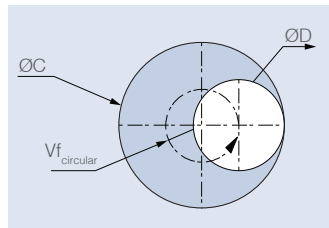

$$Vf_{circular} = ((C-D)/C) \times Vf_{linear}$$

Feed Rate Compensation

((C-D)/C) * Linear feed Rate
((30-16)/30)*720mm/min
(14/30)*720mm/min
0.466*720mm/min = 366 mm/min

Innovation : not just a marketing slogan



LAMINA MATERIAL GROUPS

TECHNICAL INFORMATION - LAMINA MATERIALS GUIDE

NON ALLOYED STEEL - LAMINA GROUP 1						
MATERIAL #	DIN	AFNOR	B5	UNI	JIS	AISI / SAE
1.0036	US137-3	-	-	FE 37BFU	-	-
1.0401	C15	CC12	080M15	C15 / C16	S15C	1015
1.0402	C22	CC20	050A20	C20 / C21	S20C / S22C	1020
1.0501	-	-	-	-	-	-
1.0503	C45	CC45	080M46	C45	S45C / S45CM	1045
1.0715	9 SMn 28	S250	230M07	CF 9 SMn 28	SUM22	1213
1.0718	9 SMnPb 28	S250Pb	-	CF 9 SMnPb 28	SUM22L / SUM23L	12L3
1.0722	10 SPb 20	-	-	-	-	-
1.0725	15 SMn 13	-	-	-	-	-
1.0726	35 S 20	-	-	-	-	-
1.0756	35 SPb 20	-	-	-	-	-
1.0760	38 SMn 28	-	-	-	-	-
1.0762	44 SMn 28	-	-	-	-	-
1.0763	44 SMnPb 28	-	-	-	-	-
1.0764	36 SMn 14	-	-	-	-	-
1.0765	36 SMnPb 14	-	-	-	-	-
1.1121	Ck 10	XC10	040 A10	2 C 10	S9 CK / S 10 C	1010
1.1133	20 Mn 5	20 M5	120 M19	20 Mn 7	SMnC 420	1022 / 1518
1.1141	Ck 15	XC 12	080 M15	C16	S15/S15CK	1015
1.1157	40 Mn 4	40 M5	150 M36	-	-	1035 / 1041
1.1158	C25E (CK 25)	XC 25	070M25	C25	S25 / S28C	1025
1.1166	35 Mn 5	-	-	-	SMn 433H	1536
1.1170	28 Mn 6	20 M5	(150 M8)	C 28 Mn	SCMn 1	1330
1.1173	30 Mn 5	35 M5	(150 M28)	-	SMn 433H / SCMn 2	1306 / 1330
1.1181	C35E (CK 35)	XC 32	080 A35	C35	S 35C	1035 / 1038
1.1183	Cf 35	XC 38TS	080 A35	C36 / C38	S35C / S35CM	1035
1.1191	C45E (CK 45)	XC 45	080 M46 / 060 A47	C45	S45C/S48C/ S45CM045CM	1045

LOW ALLOYED STEEL - LAMINA GROUP 2						
MATERIAL #	DIN	AFNOR	B5	UNI	JIS	AISI / SAE
1.0050	St 50-2	-	-	FE 50	SS50 / SS490	-
1.0060	St 60-2	-	-	FE 60-2	SM570 / SM58	-
1.0070	St 70-2	-	-	FE 70-2	FE70-2	-
1.0535	C55	-	070M55	C55	S55C / S55CM	1055
1.0601	C60	CC55	080A62	C60	S58C	1060
1.1203	C55E (CK 55)	XC 55	060 A57 / 070 M55	C50	S55C / S55CM	1055
1.1213	Cf 53	XC 48TS	060A52	C53	S50C / S50CM	1050
1.1221	C60E (CK 60)	XC 60	060A62	C60	S58C / S60CM	1060 / 1064
1.1525	C 80 W1	C 90 E2U	-	C 80 KU	-	W108
1.1545	C 105 W1	C 105 E2U	-	C 100 KU	SK3 / SUP4	W110
1.1563	C 125 W	C 120 E3U	-	C 120 KU	SK2	W112
1.1573	C 135 W	C 140 E3U	-	C 140 KU	-	-
1.1625	C 80 W2	-	BW 1B	-	SK5 / SK6	W1
1.1750	C 75 W	-	BW 1A	-	-	W1
1.2330	35 CrMo 4	34 CD 4	708 A37 / (BP20)	35 CrMo 4	-	4135 / P20
1.2332	47 CrMo 4	-	-	40 CrMo 4	-	4142
1.5415	15 Mo 3	15 D 3	1501 - 240	16 Mo3 KW	STBA12 / STFA12	ASTM A204 Gra
1.5423	16 Mo 5	-	1503 - 245 - 420	16 Mo5	-	4520
1.5622	14 Ni 6	16 N 6	-	14 Ni 6	SL9N590	ASTM A350LF5

TECHNICAL INFORMATION - LAMINA MATERIALS GUIDE

1.5711	40 NiCr 6	38 NC 6	-	-	3140	-
1.5713	13 NiCr 6	10 NC 6	-	-	3115	-
1.5732	14 NiCr 10	14 NC 11	-	16 NiCr 11	SNC 415(H)	3415
1.5752	-	-	-	-	-	-
1.5919	15 CrNi 6	-	-	-	-	3115
1.7003	-	-	-	-	-	-
1.7006	46 Cr 2	42 C 2	-	45 Cr 2	-	5045 / 5046
1.7015	15 Cr 3	15 C 2	523 M15	-	SCr 415 (H)	5015 / 5115
1.7033	34 Cr 4	32 C 4	530 A32	34 CR 4 (KB)	SCr 430 (H)	5132
1.7035	41 Cr 4	42 C 4	530 M40	-	SCr 440 (H)(M)	5140
1.7045	41 Cr 4	41 C 4	530 A40	41 Cr 4	SCr 440	5140
1.7147	20 MnCr 5	20 MC 5	-	20 MnCr 5	SMnC 420H	5120
1.7176	55 Cr 3	55 C 3	527 A60	55 Cr 3	SUP9 (A)	5155 / 5160
1.7218	25 CrMo 4	25 CD 4	708 A25	25 CrMo 4 (KB)	SCM 420 / SCM 430	4130
1.7220	34 CrMo 4	35 CD 4	708 A37	35 CrMo 4	SCCr M3 / SCM 435H	4137 / 4135
1.7223	41 CrMo 4	42 CD 4TS	708 M40	41 CrMo 4	SCM 440	4140 / 4142
1.7225	42 CrMo 4	42 CD 4	708 M40	42 CrMo 4	SCM 440(H) / SNB 7	4140 / 4142
1.7227	42 CrMoS 4	-	-	-	-	-
1.7228	50 CrMo 4	50 CD 4	708 A47	-	SCM 445 (H)	4150
1.7242	16 CrMo 4	-	-	18 CrMo 4	SCM 418 (H)	-
1.7262	15 CrMo 5	12 CD 4	-	-	SCM 415 (H)	-
1.7264	20 CrMo 5	18 CD 4	-	-	SCM 421 / SCM 420H	-
1.7335	13 CrMo 4 4	15 CD 3.5 / 4.5	1502 620 540	14 CrMo 3	SFVAF12	A182 A387 Gr. 12
1.7337	16 CrMo 4 4	15 CD 4 5	-	18 CrMo 4 5 KW	-	A 387 Gr 12 C12
1.7361	32 CrMo 12	30 CD 12	722 M24	32 CrMo 12	-	-
1.2067	102 Cr 6	Y 100 C 6	(BL3)	-	SUJ 2	L1 / L3
1.2080	X210 Cr 12	Z200 C 12	BD3	X205 Cr 12KU	SKD 1	D3
1.2210	115 CrV 3	100 C 3	-	107 CrV3 KU	-	L2
1.2241	51 CrV 4	-	-	-	-	-

HIGH ALLOYED STEEL - LAMINA GROUP 3

MATERIAL #	DIN	AFNOR	B5	UNI	JIS	AISI / SAE
1.2311	40 CrMnMo 7	-	-	35 CrMo 8 KU	-	-
1.2343	X38 CrMoV 5 1	Z38 CDV 5	BH11	X37 CrMoV51 KU	SKD 6	H 11
1.2344	X40 CrMoV 5 1	Z40 CDV 5	BH13	X40 CrMoV511 KU	SKD 61	H 13
1.2363	X100 CrMoV 5 1	Z100 CDV 5	BA2	X100 CrMoV 5 1 KU	SKD 12	A2
1.2365	X32 CrMoV 3 3	32 DCV 12 28	BH10	30 CrMoV 12 27 KU	-	H10
1.2379	X155 CrVMo 12 1	Z160 CDV 12	BD2	X155 CrVMo121 KU	SKD 11	D2
1.2419	105 WCr 6	105 WC 13	-	107 WCr 5 KU	SKS 31 / SKS 2 / SKS 3	-
1.2436	X210 CrW 12	Z210 CW 12 1	-	X215 CrW 12 1 KU	SKD 2	-
1.2510	100 MnCrW 4	90 MWCV 5	BO1	95 MnWCr 5KU	BO 1	O1
1.2542	45 WCrV 7	45 WCV 20	BS1	45 WCrV 8 KU	-	S1
1.2550	60 WCrV 7	55 WC 20	BS1	58 WCr 9 KU	-	S1
1.2567	30 WCrV 17 2	Z32 WCV 5	-	X30 WCrV 5 3 KU	SKD 4	-
1.2581	X30 WCrV 9 3	Z30 WCV 9	BH21	X30 WCrV 9 3 KU	SKD 5	H 21
1.2601	X165 CrMo V 12	-	-	X165 CrMoW 12 KU	-	-
1.2606	X37 CrMoW 5 1	Z35 CWDV 5	BH12	X35 CrMoW 05 KU	SKD 62	H 12
1.2713	55 NiCrMoV 6	55 NCDV 7	BH 244/5	-	SKT 4	L6
1.2721	50 NiCr 13	-	-	-	-	-
1.2762	75 CrMoNiW 6 7	-	-	-	-	-
1.8509	41 CrAlMo 7	40 CAD 6 12	905 M39	41 CrAlMo 7	SACM 645 / SACM 1	A 355 Cl.A / E71400
1.8515	31 CrMo 12	30 DC 12	722 M24	30 CrMo 12	-	-
1.8519	31 CrMoV 9	-	-	-	-	-
1.8523	39 CrMoV 13 9	-	897 M39	36 CrMoV 12	-	-
1.8550	34 CrAlNi 7	30 CAD 6.12	905 M31	-	-	-

TECHNICAL INFORMATION - LAMINA MATERIALS GUIDE

AUSTENITIC STAINLESS STEEL - LAMINA GROUP 4						
MATERIAL #	DIN	AFNOR	B5	UNI	JIS	AISI / SAE
1.4005	X12 CrS 13	Z11 CF 13	416 S21	X12 CrS 13	SUS 416	416
1.4104	X14 CrMoS 17	Z13 CF 17	441 S29	X10 CrS 17	SUS 430F	430F
1.4113	X6 CrMoS 17 1	Z8 CD 17 01	434 S17	X8 CrMo 17	SUS 434	434
1.4301	X5 CrNi 18 9	Z6 CN 18 9	304 S15 / LW21 / LWCF	X5 CrNi 18 10	SUS 304	304 / 304H
1.4303	X4 cr Ni 18 12	Z5 CN 18 11FF	305 S17 / 305 S19	X7 CrNi 18 10	SUS 305 / SUS 305J1	305 / 308
1.4305	X8 crNiS 18 9	Z8 CNF 18 9	303 S22 / 303 S31	X10 CrNiS 18 9	SUS 303	303
1.4306	X2 crNi 18 9	Z2 CN 18 9	304 S11 / LW20 / LWCF	X3 CrNi 18 11	SUS 304L / SCS19	304L
1.4308	G-X5 CrNi 19 10	Z6 CN 18 10M	304 C15 / LT196)	-	SCS 13	CF8
1.4310	X10 crNi 18 8	Z12 CN 17 8	301 S21 / 301 S22	X12 CrNi 18 07	SUS 301	301
1.4311	X2 crNiN 18 10	Z2 CN 18 7 Az	304 S61	X2 CrNiN 18 10	SUS 304LN	304LN
1.4312	G-X10 crNi 18 8	Z10 CN 18 9M	302 C25 / ANC3A	-	SCS 12 / SCS 13A	-
1.4567	X3 CrNiCu 18.9.4	-	304 Cu	X3 CrNiCu 18.9.4	XM7	304Cu
1.4568	X7 CrNiAl 17 7	Z CNA 17 7	301 S81	-	-	-
1.4570	X8 CrNiCuS 18.9.2	-	303 Cu	X8 CrNiCuS 18.9.2	SUS 303 Cu	303Cu
1.4401	X2 CrNiMo 17 12 2	Z6 CND 17 11 2	316 S13 / 316 S31	X5 CrNiMo 17 12	SUS 316	316
1.4404	X2 CrNiMo 17 12 2	Z2 CND 17 12 2	316 S11 / 316 S13	X2 CrNiMo 17 12	SUS 316L	316L
1.4406	X2 CrNiMoN 17 11 2	Z3 CND 17 11 Az	316 S61 / 316 S63	X2 CrNiMoN 17 12	SUS 316LN	316LN
1.4408	G-X5 CrNiMo 19 11 2	-	316 C16 / (LT196) / A	-	SCS14	CF-8M
1.4429	X2 CrNiMo 17 13 3	Z2 CND 17 12 Az	316 S63	X2 CrNiMoN 17 13	(SUS 316LN)	316LN
1.4435	X2 CrNiMo 18 14 3	Z2 CND 17 12 3	316 S11 / 316 S31	X2 CrNiMo 17 13	SUS 316L	316L
1.4436	X3 CrNiMo 17 13 3	Z6 CND 18 12 3	316 S19 / 316 S33 / LW	X5 CrNiMo 17 13	SUS 316	316
1.4438	X2 CrNiMo 18 15 4	Z2 CND 19 15 4	317 S12	X2 CrNiMo 18 16	SUS 317L	317L
1.4449	X3 CrNiMo 18 12 3	-	317 S16	X5 CrNiMo 18 15	SUS 317	317

DUPLEX STAINLESS STEEL - LAMINA GROUP 5						
MATERIAL #	DIN	AFNOR	B5	UNI	JIS	AISI / SAE
1.4057	X17 CrNi 16 2	Z15 CN 16 2	431 S29	X16 CrNi 16	SUS 431	431
1.4313	X3 CrNiMo 13 4	Z4 CND 13 4	425 C11	-	SCS 5	-
1.4319	X3 CrNiN 17 8	-	301 S26 / 302 S26	-	SUS 302	302
1.4340	G-X40 CrNi 27 4	-	-	-	-	-
1.4362	X2 CrNiN 23 4	Z2 CN 23 04 Az	-	-	-	S32304
1.4410	X2 CrNiMoN 25 7 4	-	-	-	-	-
1.4417	X2 CrNiMoSi 19 5	-	-	-	-	S31500
1.4460	X8 CrNiMoN 27 5 2	Z5 CND 27 5 Az	-	-	SUS 329J1	329
1.4462	X2 CrNiMoN 22 5 3	Z23 CND 22 5 3 Az	318 S13	-	SUS 329J3L	-
1.4500	G-X 7 NiCrMoCuNb 25 20	Z3 NCDU 25 20M	-	-	-	-
1.4510	X3 CrTi 17	Z4 CT 17	-	X6 CrTi 17	SUS 430XL	430 Ti / 439
1.4511	X3 CrNb 17	Z4 CNb 17	-	X6 CrNb 17	SUS 430LX	-
1.4521	X2 CrMoTi 18 2	-	-	-	SUS 444	443 / 444
1.4539	X1 NiCrMoCuN 25 20 3	Z2 NCDU 25 20	-	-	-	904L / UNS N08904
1.4541	X10 CrNiMoTi 18 10	Z6 CNT 18 10	321 S12 / 321 S51	X6 CrNiTi 18 11	SUS 321	321
1.4542	X5 CrNiCuNb 16 4	Z7 CNU 17 4	-	-	SUS 630 / SCS 24	630
1.4546	X5 CrNiNb 18 10	-	347 SD31	X6 CrNiNb 18 11	-	348
1.4550	X6 CrNiNb 18 10	Z6 CNNb 18 10	347 S20 / 347 S31	X6 CrNiNb 18 11	SUS 347	347 / 348
1.4552	G-X5 CrNiNb 19 11	Z4 CNNb 18 10M	347 C17	-	SCS 21	-
1.4558	X2 NiCrAlTi 32 20	-	NA15	-	-	N 08800
1.4562	X1 NiCrMoCu 32 28 7	-	-	-	-	N 08031
1.4563	X1 NiCrMoCuN 31 27 4	Z1 NCDU 31 27	-	-	-	N 08028
1.4571	X6 CrNiMoTi 17 12 2	Z6 CNDT 17 12	320 S18 / 320 S31	X6 CrNiMoTi 17 12	SUS 316Ti	316Ti
1.4580	X6 CrNiMoNb 17 12 2	Z6 CNDNb 17 12	318 S17	X6 CrNiMoNb 17 12	-	(316 Cb)
1.4581	G-X5 CrNiMoNb 19 11 2	Z4 CNDNb 18 12M	318 C17 / ANC4C	G-X6 CrNiMoNb 20 11	-	-

TECHNICAL INFORMATION - LAMINA MATERIALS GUIDE

1.4583	X10 CrNiMoNb 18 12	-	-	X6 CrNiMoNb 17 13	-	318
1.4585	G-X7 CrNiMoCuNb 18 18	-	-	X6 CrNiMoSi 17 12	-	-
1.4747	X80 CrNiSi 20	Z80 CNS 20 2	443 S85	X80 CrNiSi 20	SUH 4	HNv6
1.4821	X20 CrNiSi 25 4	Z80 CNS 25 04	-	-	-	-
1.4823	G-X40 CrNiSi 27 4	-	-	-	-	-
1.4828	X15 CrNiSi 20 12	Z17 CNS 20 12	309 S24	X16 CrNi 23 14	SUH 309	309
1.4833	X12 CrNi 22 13	Z15 CN 24 13	309 S13	X6 CrNi 23 14	-	309S
1.4837	G-X40 CrNiSi 25 12	-	309 C30	G-X40 CrNiSi 25 12	SCH 17 / SCH 13A	-
1.4841	X15 CrNiSi 25 20	Z15 CNS 25 20	314 S25	X15 CrNiSi 25 20	SUH 310	310 / 314
1.4845	X12 CrNi 25 21	Z12 CN 25 20	310 S24	X6 CrNi 25 20	SUS 310	310
1.4848	G-X40 CrNiSi 25 20	-	310 C40 / 310 C45	G-X40 CrNiSi 26 20	SCH 21 / SCH 22	HK
1.4864	X12 NiCrSi 35 16	Z12 NCS 33 16	NA17	-	SUH 330	330
1.4865	G-X40 NiCrSi 38 18	-	330 C11 / 330 C40	G-X50 NiCrSi 39 19	SCH 15 / SCH 16	-
1.4873	X45 CrNiW 18 9	Z45 CNW 18 9	-	X45 CrNiW 18 9	SUH 31	-
1.4876	X10 NiCrAlTi 32 20	Z10 NC 32 21	NA15(H)	-	NCF 800(TP)	B163
1.4878	X12 CrNiTi 18 9	Z6 CNT 18 10	321 S51	(X6 CrNiTi 18 11)	SUS 321	321
1.4882	X50 CrMnNiNbN 219	Z50 CMNnb 21 9	-	-	-	-
1.4958	X5 NiCrAlTi 31 20	-	-	-	-	-
1.4977	X40 CoCrNi 20 20	Z42 CNKDWNb	-	-	-	-

FERRITIC & MARTENSITIC STAINLESS STEEL - LAMINA GROUP 6

MATERIAL #	DIN	AFNOR	B5	UNI	JIS	AISI / SAE
1.4000	X6 Cr 13	Z6 C 13	403 S17	X6 Cr 13	SUS 403 / SUS 410S	403 / 410S / 429
1.4001	X7 Cr 14	Z8 C 13FF	403 S17	X6 Cr 13	SUS 403 / SUS 401S	403 / 410S / 429
1.4002	X6 CrAl 13	Z8 CA 12	405 S17	X6 CrAl 13	SUS 405	405
1.4008	G-X 7 CrNiMo 12 1	Z12 CN 13M	410 C21	GX12 Cr 13	-	-
1.4016	X8 Cr 17	Z8 C 17	403 S17 / 430 S18	X8 Cr 17	SUS 430	430
1.4742	X10 CrAl 18	Z12 CAS 18	403 S15	X8 Cr 17	SUH 21	-
1.4762	X10 CrAl 24	Z10 CAS 24	-	X16 Cr 26	(SUH 446)	446
1.2083	X42 Cr 13	Z40 C 14	-	-	SUS 420J2	420
1.4006	X12 Cr 13	Z10 C 13	410 S21 / 410 C21	X12 Cr 13	SUS 410	410
1.4011	G-X 12 Cr 12	-	ANC1A	-	-	CA-15
1.4021	X20 Cr 13	Z20 C 13	420 S37	X20 Cr 13	SUS 420J1	420
1.4024	X15 Cr 13	Z15 C 13	420 S29	-	SUS 410J1	410
1.4027	G-X20 Cr 14	Z20 C 13M	420 C24 / 420 C29	-	SCS 2	-
1.4028	X30 Cr 13	Z30 C 13	420 S45	(G) X30 Cr 13	SUS 420J2	420F
1.4031	X39 Cr 13	Z40 C 14	-	X40 Cr 13	SUS 420J2	-
1.4034	X46 Cr 13	Z44 C 14	(420 S45)	X40 Cr 14	-	-
1.4531	X40 CrSiMo 10 2	Z40 CSD 10	-	-	SUH 3	-
1.4718	X45 CrSi 9 3	Z45 CS 9	401 S45	X45 CrSi 8	SUH 1	HNv3
1.4720	X20 CrMo 13	-	-	-	-	-
1.4724	X10 CrAl 13	Z10 C 13	-	X10 CrAl 12	SUH 405	405

TECHNICAL INFORMATION - LAMINA MATERIALS GUIDE

CAST IRON GREY - LAMINA GROUP 7						
MATERIAL #	DIN	AFNOR	B5	UNI	JIS	AISI / SAE
0.6010	EN-GJL 100 / GG 10	F1 10D	-	G 10	FC 100	CLASS 20
0.6015	EN-GJL 150 / GG 15	F1 15D	GRADE 150	G 15	FC 150	CLASS 25
0.6020	EN-GJL 200 / GG 20	F1 20D	GRADE 220	G 20	FC 200	CLASS 30
0.6025	EN-GJL 250 / GG 25	F1 25D	GRADE 260	G 25	FC 250	CLASS 35
0.6030	EN-GJL 300 / GG 30	F1 30D	GRADE 300	G 30	FC 300	CLASS 45
0.6035	EN-GJL 350 / GG 35	F1 35D	GRADE 350	G 35	FC 350	CLASS 50
0.6040	EN-GJL 400 / GG 40	F1 40D	GRADE 400	-	-	CLASS 55

CAST IRON MALLEABLE & NODULAR - LAMINA GROUP 8						
MATERIAL #	DIN	AFNOR	B5	UNI	JIS	AISI / SAE
0.7033	EN-GJS 350/GGG 35.3	-	-	-	-	-
0.7040	EN-GJS 400/GGG 40	FCS 400-12	SNG420/12	GGG 40	FCD 400	60-40-18
0.7043	EN-GJS 400-15/GGG 40.3	FCS 370-17	SNG370/17	-	-	-
0.7050	EN-GJS 500/GGG 50	FCS 500-7	SNG500/7	GGG 50	FCD 500	80-55-06
0.7060	EN-GJS 6007/GGG 60	FCS 600-3	SNG600/3	GGG 60	FCD 600	-
0.7070	EN-GJS 700/GGG 70	FCS 700-2	SNG700/2	GGG 70	FCD 700	1000-70-03
0.8035	GTW-35	MB35-7	W340/3	-	-	-
0.8040	GTW-40	MB40-10	W410/4	-	-	-
0.8045	GTW-45	-	-	GMB45	-	-
0.8055	GTW-55	-	-	-	-	-
0.8065	GTW-65	-	-	-	-	-
0.8135	GTS-35	MN35-10	B340/12	-	FCMW 330	32510
0.8145	GTS-45	-	P440/7	-	FCMW 370	40010
0.8155	GTS-55	MP50-5	PS10/4	-	FCMP 490	50005
0.8165	GTS-65	MP60-3	P570/3	-	FCMP 540	70003
0.8170	GTS-70	M870-2	P690/2	-	-	90001

FE, NI & CO BASED HIGH TEMPERATURE ALLOYS - LAMINA GROUP 9						
MATERIAL #	DIN	AFNOR	B5	UNI	JIS	AISI / SAE
2.4360	NiCu 30 Fe	NU 30	NA13	-	Monel 400	Monel 400
2.4375	NiCu 30 Al	ND 30 AT	NA18	-	Monel K-500	Monel K-500
2.4610	NiMo 16Cr 16Ti	-	-	-	Hastelloy C-4	Hastelloy C-4
2.4630	NiCr 20 Ti	NC 20 T	HR 5, 203-4	-	Nimonic 75	Nimonic 75
2.4642	NiCr 29 Fe	NC 30 Fe	-	-	Inconel 690	Inconel 690
2.4668	NiCr 19 FeNbMo	NC 19 Fe Nb	-	-	Inconel 718	Inconel 718
2.4669	NiCr 15 Fe7TiAl	NC 15 TNb A	-	-	Inconel X-750	Inconel X-750
2.4685	G-NiMo 28	-	-	-	Hastelloy B	Hastelloy B
2.4694	NiCr 16 Fe7TiAl	-	-	-	Inconel 751	Inconel 751
2.4810	G-NiMo 30	-	-	-	Hastelloy C	Hastelloy C
2.4856	NiCr 22Mo 9Nb	NC 22 FeDNb	NA21	-	Inconel 625	Inconel 625
2.4858	NiCr 21 Mo	NC 21 FeDU	NA16	-	Incoloy 825	Incoloy 825
-	Stellite 6	Stellite 6	-	-	-	VF2
-	Stellite 7	Stellite 7	-	-	-	-
-	Stellite 12	Stellite 12	-	-	-	VF7
-	Stellite F	Stellite F	-	-	-	-

TECHNICAL INFORMATION - LAMINA MATERIALS GUIDE

TI BASED HIGH TEMPERATURE ALLOYS - LAMINA GROUP 10

MATERIAL #	DIN	AFNOR	B5	UNI	JIS	AISI / SAE
3.7025	Ti 1	-	2TA1	-	-	R 50250 / Titan Grade 2
3.7115	TiAl 5 Sn 2	-	-	-	-	-
3.7124	TiCu 2	-	2TA21-24	-	-	-
3.7145	TiAl 16 Sn 2 Zr 4 Mo 2 S	-	-	-	-	R 54620
3.7165	TiAl 6 V 4	TA 6 V	TA 10-13; TA28	-	-	R 56400 / Titan Grade 5
3.7175	TiAl 6 V 6 Sn 2	-	-	-	-	-
3.7185	TiAl 4 Mo 4 Sn 2	-	TA 45-51; TA 57	-	-	-
3.7195	TiAl 3 V 2.5	-	-	-	-	-
3.7225	Ti-35A 0.2PD	-	TP1	-	-	R 52250 / Titan Grade 1
3.7235	Ti-50A 0.2PD	-	-	-	-	Titan Grade 7

AL (>8%SI) NON-FERROUS - LAMINA GROUP 12

MATERIAL #	DIN	AFNOR	B5	UNI	JIS	AISI / SAE
3.2573	G-AISI9	-	-	-	-	-
3.2581	G-AISI12	-	-	-	-	-
3.2583	G-AISI12 Cu	-	-	-	-	-

AL (<8%SI) NON-FERROUS - LAMINA GROUP 13

MATERIAL #	DIN	AFNOR	B5	UNI	JIS	AISI / SAE
3.1255	AlCuSiMn	A-U4SG	-	-	-	-
3.1325	AlCuMg 1	A-U4G	-	-	-	-
3.1645	AlCuMgPb	A-U4Pb	-	-	-	-
3.2153	G-AISI7 Cu3	-	-	-	-	-
3.2315	AlMgSi 1	A-SGMo,7	-	-	-	-
3.3355	AlMg 5	-	-	-	-	-
3.3535	AlMg 3	A-G3M	-	-	-	-

COOPER ALLOYS NON-FERROUS - LAMINA GROUP 14

MATERIAL #	DIN	AFNOR	B5	UNI	JIS	AISI / SAE
2.0966	CuAl10 Ni5 Fe4	CuAl9 Ni5 Fe3 M1	CA 104	-	-	CDA / C63000
2.1052	CuSn 12 Ni	-	1400 PB2	-	-	CDA / C91700
2.1090	CuSn7 ZNPb	U-E7 Z5 Pb4	BS 1400	-	-	CDA / C93200
2.1176	CuPb10 SN	U PB8	1400 LB2	-	-	CDA / C94400

Pioneers of Multi-Mat™



INSERT INDEX

TECHNICAL INFORMATION - INSERT INDEX

DESIGNATION	CATALOG #	PAGE	DOC / FEED	Vc
ADKT 1505 PDTR LT 30	M0001573	100	227	226
ADKT 1505 PDTR LT 3000	M0002209	100	227	226
AOMT 123608 PETR LT 30	M0001640	102	228	226
AOMT 123608 PETR LT 3000	M0002210	102	228	226
APGT 100304 PDER-ALU LT 05	M0003089	142	282	280
APGT 160408 PDER-ALU LT 05	M0001010	142	282	280
APKT 060204 PDTR LT 3000	M0004026	94	229	226
APKT 060204 PDTR LT 3130	M0004468	94	229	226
APKT 0602-HF LT 3000	M0004296	114	230	226
APKT 0602-HF LT 3130	M0004469	114	230	226
APKT 100304 PDTR LT 30	M0002920	95	231	226
APKT 100304 PDTR LT 3000	M0003389	94	231	226
APKT 100308 PDTR LT 30	M0002918	95	232	226
APKT 100308 PDTR LT 3000	M0003388	94	232	226
APKT 100308 PDTR LT 3130	M0004470	94	232	226
APKT 100312 PDTR LT 30	M0002921	95	233	226
APKT 100312 PDTR LT 3000	M0003391	94	233	226
APKT 100316 PDTR LT 30	M0003094	95	234	226
APKT 100316 PDTR LT 3000	M0003392	94	234	226
APKT 100332 PDTR LT 30	M0002922	95	235	226
APKT 100332 PDTR LT 3000	M0003394	94	235	226
APKT 100340 PDTR LT 30	M0002923	95	236	226
APKT 100340 PDTR LT 3000	M0003395	94	236	226
APKT 1604 PDTR LT 30	M0000021	95	237	226
APKT 160408 PDTR LT 30	M0000022	95	237	226
APKT 160408 PDTR LT 3000	M0002182	94	237	226
APKT 160408 PDTR LT 3130	M0004471	94	237	226
APKT 160416 PDTR LT 30	M0000172	95	238	226
APKT 160416 PDTR LT 3000	M0004027	94	238	226
APKT 160424 PDTR LT 30	M0003833	95	239	226
APKT 160424 PDTR LT 3000	M0004029	94	239	226
APKT 160432 PDTR LT 30	M0001569	95	240	226
APKT 160432 PDTR LT 3000	M0004030	94	240	226
APKT 1705 PETR LT 30	M0001810	95	241	226
APKT 1705 PETR LT 3000	M0002212	94	241	226
APKW 0602-HF LT 3000	M0004297	114	242	226
APKW 0602-HF LT 3130	M0004472	114	242	226
APMT 1135 PDTR LT 30	M0001133	104	243	226
APMT 1135 PDTR LT 3000	M0002216	104	243	226
APMT 1604 PDTR LT 30	M0001134	104	244	226
APMT 1604 PDTR LT 3000	M0002183	104	244	226
APMT 160408 PDTR LT 30	M0001733	104	244	226
APMT 160408 PDTR LT 3000	M0002218	104	244	226
CCGT 060204 ALU LT 05	T0004162	44	281	280
CCGT 09T304 ALU LT 05	T0004163	44	281	280
CCMT 060204 NN LT 10	T0000055	16	191	187
CCMT 060204 NN LT 1000	T0001888	16	191	187
CCMT 09T304 NN LT 10	T0000056	16	188	187
CCMT 09T304 NN LT 1000	T0001889	16	188	187
CCMT 09T308 NN LT 10	T0000117	16	189	186
CCMT 09T308 NN LT 1000	T0001890	16	189	186
CCMT 120404 NN LT 10	T0001456	16	188	187
CCMT 120404 NN LT 1000	T0001891	16	188	187

DESIGNATION	CATALOG #	PAGE	DOC / FEED	Vc
CCMT 120408 NN LT 10	T0001457	16	192	186
CCMT 120408 NN LT 1000	T0001892	16	192	186
CCMT 120412 NN LT 10	T0001776	16	190	186
CCMT 120412 NN LT 1000	T0001893	16	190	186
CNGG 09T304 ALU LT 05	T0003298	44	281	280
CNGG 120404 ALU LT 05	T0001025	44	281	280
CNGG 120408 ALU LT 05	T0001019	44	281	280
CNMA 120408 LT 1005	T0004050	16	223	187
CNMA 120412 LT 1005	T0004051	16	223	187
CNMG 120404 NN LT 10	T0000491	17	188	187
CNMG 120404 NN LT 1000	T0001895	17	188	187
CNMG 120408 NM LT 10	T0001966	17	188	186
CNMG 120408 NM LT 1000	T0001968	17	206	186
CNMG 120408 NM LT 1005	T0004053	17	206	186
CNMG 120408 NM LT 1025	T0004111	17	206	186
CNMG 120408 NN LT 10	T0000059	17	204	186
CNMG 120408 NN LT 1000	T0001896	17	204	186
CNMG 120408 NN LT 1005	T0004054	17	204	186
CNMG 120408 NN LT 1025	T0004112	17	204	186
CNMG 120408 NX LT 1000	T0002741	17	203	186
CNMG 120408 NX LT 1005	T0004055	17	203	186
CNMG 120408 NX LT 1025	T0004113	17	203	186
CNMG 120412 NN LT 10	T0000061	17	205	186
CNMG 120412 NN LT 1000	T0001897	17	205	186
CNMG 120412 NN LT 1005	T0004056	17	205	186
CNMG 120412 NN LT 1025	T0004114	17	205	186
CNMM 120408 NR LT 10	T0000669	18	215	186
CNMM 120408 NR LT 1025	T0004115	18	215	186
CNMM 120412 NR LT 10	T0000671	18	216	186
CNMM 120412 NR LT 1000	T0001899	18	216	186
CNMM 120412 NR LT 1025	T0004116	18	216	186
CNMP 120408 NN LT 1000	T0001900	18	217	186
CNMP 120408 NN LT 1025	T0004117	18	217	186
CNMP 120412 NN LT 1000	T0001901	18	218	186
CNMP 120412 NN LT 1025	T0004118	18	218	186
CPMT 060204 NN LT 1000	T0003088	19	191	187
CPMT 060208 NN LT 1000	T0003144	19	202	186
CPMT 09T304 NN LT 1000	T0003145	19	188	187
CPMT 09T308 NN LT 1000	T0003146	19	189	186
DCGT 11T304 ALU LT 05	T0004164	44	281	280
DCMT 070204 NN LT 10	T0000064	21	191	187
DCMT 070204 NN LT 1000	T0001902	21	191	187
DCMT 11T304 NN LT 10	T0000065	21	188	187
DCMT 11T304 NN LT 1000	T0001903	21	188	187
DCMT 11T308 NN LT 10	T0000721	21	189	186
DCMT 11T308 NN LT 1000	T0001904	21	189	186
DNGG 110404 ALU LT 05	T0001026	44	281	280
DNGG 110408 ALU LT 05	T0001010	44	281	280
DNMA 150608 LT 1005	T0003241	21	223	187
DNMA 150612 LT 1005	T0003242	21	223	187
DNMG 110404 NN LT 10	T0000066	22	188	187
DNMG 110404 NN LT 1000	T0001905	22	188	187
DNMG 110408 NN LT 10	T0000675	22	204	186

TECHNICAL INFORMATION - INSERT INDEX

DESIGNATION	CATALOG #	PAGE	DOC / FEED	Vc
DNMG 110408 NN LT 1000	T0001906	22	204	186
DNMG 110408 NN LT 1005	T0004059	22	204	186
DNMG 110408 NN LT 1025	T0004119	22	204	186
DNMG 150404 NN LT 10	T0000476	22	188	187
DNMG 150404 NN LT 1000	T0001907	22	188	187
DNMG 150408 NN LT 10	T0000475	22	204	186
DNMG 150408 NN LT 1000	T0001908	22	204	186
DNMG 150408 NN LT 1005	T0004061	22	204	186
DNMG 150408 NN LT 1025	T0004121	22	204	186
DNMG 150408 NX LT 1000	T0003097	22	203	186
DNMG 150408 NX LT 1005	T0004062	22	203	186
DNMG 150408 NX LT 1025	T0004122	22	203	186
DNMG 150412 NN LT 10	T0001021	22	205	186
DNMG 150412 NN LT 1000	T0001909	22	205	186
DNMG 150412 NN LT 1005	T0004064	22	205	186
DNMG 150412 NN LT 1025	T0004124	22	205	186
DNMG 150604 NN LT 10	T0000583	22	188	187
DNMG 150604 NN LT 1000	T0001910	22	188	187
DNMG 150608 NN LT 10	T0000067	22	204	186
DNMG 150608 NN LT 1000	T0001911	22	204	186
DNMG 150608 NN LT 1005	T0004067	22	204	186
DNMG 150608 NN LT 1025	T0004126	22	204	186
DNMG 150608 NX LT 1000	T0003220	22	203	186
DNMG 150608 NX LT 1005	T0004063	22	203	186
DNMG 150608 NX LT 1025	T0004123	22	203	186
DNMG 150612 NN LT 10	T0000672	22	205	186
DNMG 150612 NN LT 1000	T0001912	22	205	186
DNMG 150612 NN LT 1005	T0004068	22	205	186
DNMG 150612 NN LT 1025	T0004127	22	205	186
DNMX 150608 R11 LT 1000	T0002793	23	220	186
DNMX 150608 R11 LT10	T0002157	23	220	186
GCTX 2002 NN LT 1000	T0002825	50	285	284
GCTX 3003 NN LT 1000	T0002826	50	285	284
GCTX 3003 PP LT 1000	T0002828	50	285	284
HNKX 0604-45 LT 3000	M0004364	76	245	226
HNKX 0604-45 LT 3130	M0004473	76	245	226
KNUX 160405 L LT 10	T0003884	25	221	187
KNUX 160405 R LT 10	T0000951	25	221	187
LDMT 1504 PDSR LT30	M0001772	109	246	226
MGMN 200 G LT 10	T0003909	50	286	284
MGMN 300 M LT 10	T0003910	50	286	284
MGMN 400 M LT 10	T0003911	50	286	284
MGMN 500 M LT 10	T0003921	50	286	284
ODMT 0504 ZZTR LT 30	M0000664	86	247	226
ODMT 0504 ZZTR LT 3000	M0003399	86	247	226
ODMT 060508 TN LT 30	M0001104	86	248	226
ODMT 060508 TN LT 3000	M0002219	86	248	226
ODMW 060508 TN LT 30	M0000451	86	249	226
ODMW 060508 TN LT 3000	M0003400	86	249	226
ODMW 060508 TN LT 3130	M0004474	86	249	226
OFER 070405 TN LT 30	M0000033	90	250	226
OFER 070405 TN LT 3000	M0003401	90	250	226
OFMT 050405 TR LT 30	M0000034	88	247	226

DESIGNATION	CATALOG #	PAGE	DOC / FEED	Vc
OFMT 050405 TR LT 3000	M0002220	88	247	226
OFMT 05T305 TN LT 30	M0000591	88	247	226
OFMT 05T305 TN LT 3000	M0002221	88	247	226
OFMT 070405 TN LT 30	M0000592	88	250	226
OFMT 070405 TN LT 3000	M0002222	88	250	226
ONKX 0806-45 LT 30	M0003673	78	251	226
ONKX 0806-45 LT 3000	M0002211	78	251	226
ONKX 0806-45 LT 3130	M0004475	78	251	226
RCMT 0602 M0 LT 10	T0000090	27	193	186
RCMT 0602 M0 LT 1000	T0001914	27	193	186
RCMT 0803 M0 LT 10	T0000091	27	194	186
RCMT 0803 M0 LT 1000	T0001915	27	194	186
RCMT 10T3 M0 LT 10	T0000092	27	195	186
RCMT 10T3 M0 LT 1000	T0001916	27	195	186
RCMT 1204 M0 LT 10	T0000093	27	196	186
RCMT 1204 M0 LT 1000	T0001917	27	196	186
RDMT 0602 M0 LT 30	M0000035	124	252	226
RDMT 0602 M0 LT 3000	M0003403	124	252	226
RDMT 0702 M0 LT 30	M0001882	124	253	226
RDMT 0702 M0 LT 3000	M0003404	124	253	226
RDMT 0803 M0 LT 30	M0000037	124	254	226
RDMT 0803 M0 LT 3000	M0003405	124	254	226
RDMT 1003 M0 LT 30	M0001875	124	255	226
RDMT 1003 M0 LT 3000	M0002224	124	255	226
RDMT 10T3 M0 LT 30	M0000038	124	255	226
RDMT 10T3 M0 LT 3000	M0002225	124	255	226
RDMT 1204 M0 LT 30	M0000039	124	256	226
RDMT 1204 M0 LT 3000	M0002226	124	256	226
RDMT 12T3 M0 LT 30	M0001876	124	256	226
RDMT 12T3 M0 LT 3000	M0002227	124	256	226
RDMT 1604 M0 LT 30	M0001881	124	257	226
RDMT 1604 M0 LT 3000	M0003407	124	257	226
RDMW 1003 M0 LT 30	M0004452	125	258	226
RDMW 1003 M0 LT 3000	M0004424	125	258	226
RDMW 10T3 M0 LT 30	M0001550	125	258	226
RDMW 10T3 M0 LT 3000	M0002228	125	258	226
RDMW 1204 M0 LT 30	M0001551	125	258	226
RDMW 1204 M0 LT 3000	M0003408	125	258	226
RDMW 12T3 M0 LT 30	M0004453	125	258	226
RDMW 12T3 M0 LT 3000	M0004425	125	258	226
RDMX 1003 M0 LT 30	M0004454	125	255	226
RDMX 1003 M0 LT 3000	M0004426	125	255	226
RDMX 10T3 M0 LT 30	M0001552	125	255	226
RDMX 10T3 M0 LT 3000	M0003409	125	255	226
RDMX 1204 M0 LT 30	M0001553	125	256	226
RDMX 1204 M0 LT 3000	M0003410	125	256	226
RDMX 12T3 M0 LT 30	M0004455	125	256	226
RDMX 12T3 M0 LT 3000	M0004427	125	256	226
RXMT 10T3 M0 LT 3000	M0004171	128	255	226
RXMT 10T3 M0 LT 3130	M0004476	128	255	226
RXMT 1204 M0 LT 3000	M0004366	128	256	226
RXMT 1204 M0 LT 3130	M0004477	128	256	226
RXMW 10T3 M0 LT 3000	M0004371	128	258	226

TECHNICAL INFORMATION - INSERT INDEX

DESIGNATION	CATALOG #	PAGE	DOC / FEED	Vc
RXMW 10T3 M0 LT 3130	M0004478	128	258	226
RXMW 1204 M0 LT 3000	M0004375	128	258	226
RXMW 1204 M0 LT 3130	M0004479	128	258	226
RXMX 10T3 M0 LT 3000	M0004373	129	255	226
RXMX 10T3 M0 LT 3130	M0004480	129	255	226
RXMX 1204 M0 LT 3000	M0004377	129	256	226
RXMX 1204 M0 LT 3130	M0004481	129	256	226
SCMT 09T304 NN LT 10	T0001459	29	197	187
SCMT 09T304 NN LT 1000	T0001918	29	197	187
SCMT 09T308 NN LT 10	T0001458	29	189	186
SCMT 09T308 NN LT 1000	T0001919	29	189	186
SDKT 1204 AETN LT 30	M0000171	80	259	226
SDKT 1204 AETN LT 3000	M0003411	80	259	226
SDKW 0904-HF LT 3000	M0004263	116	260	226
SDKW 0904-HF LT 3130	M0004482	116	260	226
SDKW 1205-HF LT 3000	M0004224	116	260	226
SDKW 1205-HF LT 3130	M0004483	116	260	226
SDKX 0904-HF LT 3000	M0003412	116	261	226
SDKX 0904-HF LT 3130	M0004484	116	261	226
SDKX 1205-HF LT 3000	M0003413	116	262	226
SDKX 1205-HF LT 3130	M0004485	116	262	226
SEGT 1204 AFEN-ALU LT 05	M0001008	145	282	280
SEKN 1203 AFTN LT 30	M0000041	82	263	226
SEKN 1203 AFTN LT 3000	M0004031	82	263	226
SEKN 1204 AFTN LT 30	M0000042	82	263	226
SEKN 1204 AFTN LT 3000	M0004032	82	263	226
SEKN 1504 AFTN LT 30	M0000450	82	264	226
SEKN 1504 AFTN LT 3000	M0004033	82	264	226
SEKR 1203 AFTN LT 30	M0000043	82	263	226
SEKR 1203 AFTN LT 3000	M0004034	82	263	226
SEKR 1204 AFTN LT 30	M0000044	82	263	226
SEKR 1204 AFTN LT 3000	M0004035	82	263	226
SEKT 1204 AFTN LT 30	M0000045	72	265	226
SEKT 1204 AFTN LT 3000	M0002230	72	265	226
SEKT 1204 AFTN LT 3130	M0004486	72	265	226
SEKT 12T3 AGSN LT 30	M0000455	72	265	226
SEKT 12T3 AGSN LT 3000	M0002231	72	265	226
SEKT 12T3 AGSN LT 3130	M0004487	72	265	226
SNKX 1205-45 LT 30	M0003221	74	266	226
SNKX 1205-45 LT 3000	M0003415	74	266	226
SNKX 1205-45 LT 3130	M0004490	74	266	226
SNKX 1607-45 LT 30	M0002205	74	267	226
SNKX 1607-45 LT 3000	M0002237	74	267	226
SNKX 1607-45 LT 3130	M0004491	74	267	226
SNMA 120408 LT 1005	T0003239	29	223	187
SNMA 120412 LT 1005	T0003240	29	223	187
SNMG 120408 NN LT 10	T0000322	30	208	186
SNMG 120408 NN LT 1000	T0001921	30	208	186
SNMG 120408 NN LT 1005	T0004076	30	208	186
SNMG 120408 NN LT 1025	T0004133	30	208	186
SNMG 120408 NX LT 1000	T0003011	30	207	186
SNMG 120408 NX LT 1005	T0004077	30	207	186

DESIGNATION	CATALOG #	PAGE	DOC / FEED	Vc
SNMG 120408 NX LT 1025	T0004134	30	207	186
SNMG 120412 NN LT 10	T0000323	30	209	186
SNMG 120412 NN LT 1000	T0001922	30	209	186
SNMG 120412 NN LT 1005	T0004078	30	209	186
SNMG 120412 NN LT 1025	T0004136	30	209	186
SPKN 1203 EDTR LT 30	M0000046	84	268	226
SPKN 1203 EDTR LT 3000	M0004036	84	268	226
SPKN 1204 EDTR LT 30	M0000047	84	268	226
SPKN 1204 EDTR LT 3000	M0004181	84	268	226
SPKN 1504 EDTR LT 30	M0001673	84	268	226
SPKN 1504 EDTR LT 3000	M0004037	84	268	226
SPKR 1203 EDTR LT 30	M0000048	84	269	226
SPKR 1203 EDTR LT 3000	M0004038	84	269	226
SPKR 1204 EDTR LT 30	M0000049	84	269	226
SPKR 1204 EDTR LT 3000	M0004182	84	269	226
SPMG 050204 NN LT 30	M3003882	174	311	310
SPMG 060204 NN LT 30	M3002913	174	311	310
SPMG 07T308 NN LT 30	M3002914	174	311	310
SPMG 090408 NN LT 30	M3002915	174	311	310
SPMG 110408 NN LT 30	M3003883	174	311	310
SPMT 060304 TN LT 30	M0003100	136	270	226
SPMT 060304 TN LT 3000	M0003416	136	270	226
SPMT 09T308 TN LT 30	M0003063	136	271	226
SPMT 09T308 TN LT 3000	M0003417	136	271	226
SPMT 120408 TN LT 30	M0003105	136	272	226
SPMT 120408 TN LT 3000	M0003419	136	272	226
SPMT 12T308 LT 30	M0001226	110	273	226
SPMT 12T308 LT 3000	M0003420	110	273	226
SPUN 120308 LT 30	M0000050	81	274	226
SPUN 120308 LT 3000	M0004039	81	274	226
TCMT 110204 NN LT 10	T0000477	31	191	187
TCMT 110204 NN LT 1000	T0001924	31	191	187
TCMT 110208 NN LT 10	T0000478	31	198	186
TCMT 110208 NN LT 1000	T0001925	31	198	186
TCMT 16T304 NN LT 10	T0000479	31	188	187
TCMT 16T304 NN LT 1000	T0001927	31	188	187
TCMT 16T308 NN LT 10	T0000068	31	200	186
TCMT 16T308 NN LT 1000	T0001928	31	200	186
TCMT 16T312 NN LT 10	T0001774	31	199	186
TCMT 16T312 NN LT 1000	T0001929	31	199	186
TNGG 160404 ALU LT 05	T0001105	45	281	280
TNMA 160408 LT 1005	T0002837	31	223	187
TNMA 160412 LT 1005	T0003238	31	223	187
TNMG 160404 NN LT 10	T0000457	32	188	187
TNMG 160404 NN LT 1000	T0001931	32	188	187
TNMG 160408 NN LT 10	T0000069	32	204	186
TNMG 160408 NN LT 1000	T0001932	32	204	186
TNMG 160408 NN LT 1005	T0004082	32	204	186
TNMG 160408 NN LT 1025	T0004138	32	204	186
TNMG 160408 NX LT 1000	T0003012	32	203	186
TNMG 160408 NX LT 1005	T0004083	32	203	186
TNMG 160408 NX LT 1025	T0004139	32	203	186

TECHNICAL INFORMATION - INSERT INDEX

DESIGNATION	CATALOG #	PAGE	DOC / FEED	Vc
TNMG 160412 NN LT 10	T0001734	32	205	186
TNMG 160412 NN LT 1000	T0001933	32	205	186
TNMG 160412 NN LT 1005	T0004084	32	205	186
TNMG 160412 NN LT 1025	T0004140	32	205	186
TNMG 220404 NN LT 10	T0001873	32	188	187
TNMG 220404 NN LT 1000	T0001934	32	188	187
TNMG 220408 NN LT 10	T0000113	32	204	186
TNMG 220408 NN LT 1000	T0001935	32	204	186
TNMG 220408 NN LT 1005	T0004086	32	204	186
TNMG 220408 NN LT 1025	T0004142	32	204	186
TNMG 220408 NX LT 1000	T0003013	32	203	186
TNMG 220408 NX LT 1005	T0004087	32	203	186
TNMG 220408 NX LT 1025	T0004143	32	203	186
TNMG 220412 NN LT 10	T0001735	32	205	186
TNMG 220412 NN LT 1000	T0001936	32	205	186
TNMG 220412 NN LT 1005	T0004088	32	205	186
TNMG 220412 NN LT 1025	T0004144	32	205	186
TNMP 160408 NN LT 10	T0000492	33	217	186
TNMP 160408 NN LT 1000	T0001937	33	217	186
TNMP 160408 NN LT 1025	T0004145	33	217	186
TNMX 160404 L LT 10	T0001877	33	188	187
TNMX 160404 L LT 1000	T0002794	33	188	187
TNMX 160404 R LT 10	T0001125	33	188	187
TNMX 160404 R LT 1000	T0001938	33	188	187
TNMX 160408 L LT 1000	T0002795	33	222	186
TNMX 160408 L LT10	T0003385	33	222	186
TNMX 160408 R LT 10	T0001137	33	222	186
TNMX 160408 R LT 1000	T0001939	33	222	186
TPKN 1603 PDTR LT 30	M0000051	106	275	226
TPKN 1603 PDTR LT 3000	M0004040	106	275	226
TPKN 2204 PDTR LT 30	M0000052	106	275	226
TPKN 2204 PDTR LT 3000	M0004041	106	275	226
TPKR 1603 PDTR LT 30	M0000053	106	276	226
TPKR 1603 PDTR LT 3000	M0004042	106	276	226
TPKR 2204 PDTR LT 30	M0000983	106	277	226
TPKR 2204 PDTR LT 3000	M0004043	106	277	226
TPMR 160304 NN LT 10	T0001638	34	188	187
TPMR 160308 NN LT 10	T0001535	34	188	186
TPUN 160308 LT 30	M0000054	108	278	226
TPUN 160308 LT 3000	M0004044	108	278	226
VBMT 110304 NN LT 10	T0001460	35	191	187
VBMT 110304 NN LT 1000	T0001942	35	191	187
VBMT 160404 NN LT 10	T0000070	35	188	187
VBMT 160404 NN LT 1000	T0001943	35	188	187
VBMT 160408 NN LT 10	T0000071	35	201	186
VBMT 160408 NN LT 1000	T0001944	35	201	186
VCMT 160404 NN LT 10	T0001102	35	188	187
VCMT 160404 NN LT 1000	T0001945	35	188	187
VCMT 160408 NN LT 10	T0001103	35	201	186
VCMT 160408 NN LT 1000	T0001946	35	201	186
VNGG 160404 ALU LT 05	T0001006	45	281	280
VNGG 160408 ALU LT 05	T0001032	45	281	280

DESIGNATION	CATALOG #	PAGE	DOC / FEED	Vc
VNMG 160404 NN LT 10	T0000072	36	188	187
VNMG 160404 NN LT 1000	T0001947	36	188	187
VNMG 160408 NN LT 10	T0000073	36	210	186
VNMG 160408 NN LT 1000	T0001948	36	210	186
VNMG 160408 NN LT 1005	T0004095	36	210	186
VNMG 160408 NN LT 1025	T0004149	36	210	186
WCMX 040208 NN LT 30	M3001122	182	312	310
WCMX 050308 NN LT 30	M3001121	182	312	310
WCMX 06T308 NN LT 30	M3000953	182	312	310
WCMX 080412 NN LT 30	M3000954	182	312	310
WGE 2000 LT 10	T0003932	50	287	284
WGE 3000 LT 10	T0003933	50	287	284
WGE 4000 LT 10	T0003934	50	287	284
WGE 5000 LT 10	T0003935	50	287	284
WNGG 060404 ALU LT 05	T0003299	45	281	280
WNGG 080404 ALU LT 05	T0003300	45	281	280
WNMA 080408 LT 1005	T0002840	37	223	187
WNMA 080412 LT 1005	T0002841	37	223	187
WNMG 060404 NN LT 10	T0000133	39	188	187
WNMG 060404 NN LT 1000	T0001949	38	188	187
WNMG 060408 NN LT 10	T0000137	39	212	186
WNMG 060408 NN LT 1000	T0001950	38	212	186
WNMG 060408 NN LT 1005	T0004099	38	212	186
WNMG 060408 NN LT 1025	T0004150	38	212	186
WNMG 060408 NX LT 1000	T0003014	38	211	186
WNMG 060408 NX LT 1005	T0004100	38	211	186
WNMG 060408 NX LT 1025	T0004151	38	211	186
WNMG 080404 NN LT 10	T0000584	39	188	187
WNMG 080404 NN LT 1000	T0001951	38	188	187
WNMG 080408 NN LT 10	T0001967	39	214	186
WNMG 080408 NN LT 1000	T0001969	38	214	186
WNMG 080408 NN LT 1005	T0004102	38	214	186
WNMG 080408 NN LT 1025	T0004153	38	214	186
WNMG 080408 NN LT 10	T0000075	39	212	186
WNMG 080408 NN LT 1000	T0001952	38	212	186
WNMG 080408 NN LT 1005	T0004103	38	212	186
WNMG 080408 NN LT 1025	T0004154	38	212	186
WNMG 080408 NX LT 1000	T0002742	38	211	186
WNMG 080408 NX LT 1005	T0004104	38	211	186
WNMG 080408 NX LT 1025	T0004155	38	211	186
WNMG 080412 NN LT 10	T0000077	39	213	186
WNMG 080412 NN LT 1000	T0001953	38	213	186
WNMG 080412 NN LT 1005	T0004105	38	213	186
WNMG 080412 NN LT 1025	T0004156	38	213	186
WNMP 060404 NN LT 10	T0000306	40	188	187
WNMP 060404 NN LT 1000	T0001954	40	188	187
WNMP 060408 NN LT 10	T0000307	40	219	186
WNMP 060408 NN LT 1000	T0001955	40	219	186
WNMP 080408 NN LT 10	T0000308	40	219	186
WNMP 080408 NN LT 1000	T0001956	40	219	186
WNMP 080408 NN LT 1005	T0004106	40	219	186
WNMP 080408 NN LT 1025	T0004157	40	219	186

Simplify your process

Decrease your tooling costs

Minimize your machining down time

Increase your production efficiency





SWISS MANUFACTURER OF CARBIDE CUTTING TOOLS

Lamina Technologies SA Switzerland

Rue Pythagore, 2
1400 Yverdon-les-Bains
Switzerland
T. +41 (0)24 423 55 55
info@lamina-tech.ch
www.lamina-tech.ch

Lamina Technologies Deutschland GmbH

Athenslebener Weg 33
39418 Staßfurt
Germany
T. +49 (3925) 329 277
info@lamina-tech.de
www.lamina-tech.ch

Lamina Technologies SA France

15 Rue Bernard Palissy
Entrepot Jeantet STJ
25300 Granges Narboz
France
T. +33 (0)6 60 52 98 72
info@lamina-tech.fr
www.lamina-tech.ch

Lamina Technologii LLC Russia

Office 406
Yuzhnoportovaya str. 5, bld.1
115088, Moscow
Russia
T. +7 499 653 93 56
info@lamina-russia.ru
www.lamina-tech.ch

Lamina Trade (Shanghai) Co.,Ltd

Room 601B, Building A,
Xinyicheng, 1618 Yishan Road,
200233 Shanghai
China
T. +86 21 6479 0515
info@lamina-tech.ch
www.lamina-tech.ch

Lamina Technologies do Brasil Ltda.

Avenida Macuco, 726
Cj. 1603/1604
04523-001 Moema
São Paulo - SP
Brazil
T. +55 11 2344 7890
info@lamina-tech.ch
www.lamina-tech.ch

Lamina Teknolojileri Kesici Takımlar Ltd ti.

Kuştepe Mahallesi Mesut
Cemil Sokak 22/B
34381 Şişli, Istanbul
Turkey
T. +90 212 292 09 21
info@laminateknolojileri.com.tr
www.lamina-tech.ch

Lamina Technologies Indonesia

Ruko The Podium Mataram
A 9 Jl.Mataram
Lippo Cikarang
Bekasi 17550
Indonesia
T. +62 (21) 2210 4851
info@lamina-tech.ch
www.lamina-tech.ch